

**stratasys**

**F120**  
**Shared Office 3D Printer**  
***USER GUIDE***

## LIABILITY STATEMENT

Stratasys shall not be liable for errors contained herein or for incidental or consequential damages in connection with the furnishing, performance, or use of this material. Stratasys makes no warranty of any kind with regard to this material, including, but not limited to, the implied warranties of merchantability and fitness for a particular purpose. It is the responsibility of the system owner/material buyer to determine that Stratasys material is safe, lawful, and technically suitable for the intended application as well as identify the proper disposal (or recycling) method consistent with local environmental regulations. Except as provided in Stratasys' standard conditions of sale, Stratasys shall not be responsible for any loss resulting from any use of its products described herein.

## COPYRIGHT STATEMENT

© Copyright 2021 Stratasys. All rights reserved.

No part of this document may be photocopied, reproduced, or translated into any human or computer language in any form, nor stored in a database or retrieval system, without prior permission in writing from Stratasys. This document may be printed for internal use only. All copies, shall contain a full copy of this copyright notice.

## TRADEMARK ACKNOWLEDGMENTS

Stratasys, the Stratasys Signet logo, FDM, F120, GrabCAD, GrabCAD Print, WaveWash, and Ecoworks are trademarks of Stratasys and/or subsidiaries or affiliates and may be registered in certain jurisdictions. All other product names and trademarks are the property of their respective owners.

## DISCLAIMER

Customer acknowledges the contents of this document and that Stratasys parts, materials, and supplies are subject to its standard terms and conditions, available on <http://www.stratasys.com/legal/terms-and-conditions-of-sale>, which are incorporated herein by reference.

The specifications and/or information on which this document is based are subject to change without notice.

# ABOUT THE F120 PRINTER

The Stratasys F120 3D printers incorporate the latest in innovative technology to provide you with precise prototypes from a CAD design. Stratasys' Fused Deposition Modeling (FDM) technology provides prototype parts, including internal features, that can be used to field-test form, fit, and function. Direct Digital Manufacturing (DDM) allows for the creation of customized end-use parts straight from 3D CAD data. The F120 printers feature a servo/belt driven XY gantry with multiple modeling material capability.

## COMPONENTS

- The F120 Printer
- Material Package(s)
- Welcome Kit (containing documentation on how to download your user guide and common tools for maintaining the printer)
- GrabCAD Print Software Package
- A Computer Workstation (not sold by Stratasys)

## F120 HIGHLIGHTS

- Envelope Size: 10 x 10 x 10 inch (254 x 254 x 254 mm)
- Material Coil Boxes: 1 model, 1 support
- Touchscreen Graphical User Interface
- Wi-Fi capabilities
- Three USB ports (2 in front, 1 in back)
- Camera for remote monitoring

## ABOUT THIS GUIDE

This guide is your introduction to building prototypes and end-use parts using a Stratasys 3D production, rapid prototype system. It is designed as a learning and reference tool that explains system operation in an easy to understand, step-by-step, process.

## HOW TO USE THIS GUIDE

This guide is divided into easy-to-follow chapters. You can read this guide chapter by chapter or use the Table of Contents when you need to quickly find specific information. Keeping this guide close to your printer will efficiently allow you to troubleshoot and maintain the printer.

## CONVENTIONS USED IN THIS GUIDE

The following conventions are used in this guide:

- When you see text in **this font**, it indicates a button being pressed via the User Interface touchscreen. For example, press the **Queue** button within the Navigation Menu.
- When you see text in **blue**, it indicates that the text is a linked reference to a specific figure, table, heading, or page number.
- Standard **bold text** is used to emphasize items within instructional sequences or indicate a navigational path you must follow to locate/start a software application, open or save a file on your workstation PC, or perform an operation when working with GrabCAD Print. The > character is used to separate items within a navigational path. For example, navigate to **File > Open** from the Main Menu.

## REVISION LOG



Translations of this guide are updated periodically. If you are consuming a translated version, please check the English version for latest revision and list of updates.

Revision	Date	Description of Changes
A	June 2019	First release of this document
B	February 2021	Updated welcome kit tools list, updated IP and MAC addresses in images, added broken filament troubleshooting, added manual calibration note, and added ribbon connector caution. Deleted incorrect material colors. Updated supported languages. Updated legal information.
C	March 2021	Added MT Connect functionality and other CE software updates.

# TABLE OF CONTENTS

<b>1 SERVICE AND SUPPORT .....</b>	<b>1</b>
Hazard Types .....	1
Product Safety Signs.....	2
Product Safety Label Locations .....	3
Potential Safety Hazard Areas .....	4
Door Locks .....	5
General Safety Practices .....	6
Environmental Requirements.....	6
<b>2 PRINTER SETUP .....</b>	<b>7</b>
Welcome Kit Contents.....	7
Identifying Your Printer .....	9
Making the Network Connection .....	9
Connecting the Power Cable .....	10
Configuring the Network.....	10
Installing GrabCAD Print.....	15
Connecting to the F120 Printer .....	15
Setting the Printer's Date and Time .....	16
Updating the Controller software Version.....	16
Adjusting the Tip Wipe Height.....	16
<b>3 SYSTEM COMPONENTS .....</b>	<b>17</b>
Access Doors and Panels.....	17
Interface Panel .....	19
Oven Door.....	20
Oven Light.....	22
Platen.....	23
Tip Wipe Assemblies .....	24
Purge Chute .....	25
Material Coil Box .....	26



Print Heads .....	27
Materials Used .....	28
Material Coil Box Memory Chip.....	29
Tips and Slice Height .....	31
Controller Software .....	32
GrabCAD Print Software .....	32

## 4 USER INTERFACE ..... 33

Navigation Menu .....	34
Display Area .....	35
Loading a File.....	37
Viewing Print Job Information.....	40
Build Status Display .....	41
Print Job Controls.....	43
Adding a Job to the Job Queue.....	45
Editing the Job Queue.....	49
Viewing Job Details .....	50
About the Sample Queue .....	52
Head Status Icons .....	54
Viewing Head Details .....	56
Material Status Icons.....	59
Viewing Material Details .....	61
Material Load Controls .....	63
Tools Page Menu .....	70
Navigation Overview .....	71
Settings .....	72
Calibration .....	83
Maintenance.....	86
Network .....	90
Power .....	96
Light .....	97

<b>5 OPERATING THE PRINTER .....</b>	<b>98</b>
Powering ON the Printer .....	98
Powering OFF the Printer .....	99
Material Coil Box Preparation .....	100
Connecting Material Coil Box To Printer.....	101
Handling/Storing Materials .....	111
Replacing a Head.....	111
Before a Build.....	113
Preparing the Printer .....	114
Selecting a Job to Build.....	115
Information Available During a Build .....	116
Build Warnings .....	117
Pausing a Build .....	118
Aborting a Build.....	119
After a Build is Complete.....	121
Job Storage.....	123
Part Build Location .....	124
Display Units .....	125
Oven Temperature Control.....	126
Touchscreen Display Brightness .....	126
Display Language .....	127
Head Odometer Status .....	127
Materials Status .....	128
Temperature Status.....	130
Software Version .....	131
MTConnect System Activation .....	132
<b>6 CALIBRATION AND ADJUSTMENTS .....</b>	<b>140</b>
Automatic Tip Calibration .....	141
Manual Tip Calibration .....	144

<b>7 MAINTENANCE .....</b>	<b>158</b>
USB Flash Drive Method.....	158
GrabCAD Print Method .....	162
USB Flash Drive Method.....	162
GrabCAD Print Method .....	165
Cleaning the Oven Chamber.....	167
Cleaning the Platen.....	167
Clean/Inspect Tip Wipe Assemblies .....	167
Cleaning the Exterior Surface of the Printer.....	170
Cleaning the Touchscreen Display.....	170
Inspecting and cleaning the tip shields .....	170
Cleaning the Oven Door glass Surfaces .....	170
Powering Off.....	172
Rear Panel .....	174
Right and Left Side Panels.....	175
Right and Left Side Louver Panels.....	178
Top Cover Assembly .....	179
3.3/5/12 VDC ATX Power Supply .....	181
Oven Thermistor.....	182
Replacing a Head.....	183
Head Ribbon Cables .....	183
Touchscreen Display .....	186
Right and Left Side Oven Blowers .....	189
Oven Door Gasket .....	190
Z Drive Belt .....	192
Y Bellows.....	193
Oven Light.....	194
Oven Door Camera .....	198
Oven Door Latch .....	199
Top Cover Interlock Sensor and Actuator.....	203





<b>8 TROUBLESHOOTING .....</b>	<b>205</b>
Warnings at Build Start.....	206
Errors Preventing a Build from Starting.....	207
Load/Unload Errors .....	209
Build Pause Warnings .....	211
Build Abort Errors .....	214
Head Warnings.....	216
Head Errors.....	216
<b>9 SUPPLEMENTARY INFO .....</b>	<b>220</b>
EMC Class A Warning.....	220
FCC Statements (U.S.A.).....	220
Canada Electromagnetic compatibility (EMC).....	221
MSDS (Material Safety Data Sheet) .....	221
Disposal of Waste Equipment by Users in Private Households in the European Union .....	221

# 1 SERVICE AND SUPPORT

This chapter provides information on service and support for the F120 as well as safety information and safety label locations.

## Service

If you have a problem with your printer that is not covered in this guide, please contact Stratasys Customer Support. Contact information is available from the Stratasys website at: <http://www.stratasys.com/customer-support/contact-customer-support>.

When calling in for service, always have your printer's software version (see "Software Version" (page 131)) and hardware serial number available (see "Identifying Your Printer" (page 9)). You may also need access to GrabCAD Print to provide a configuration file from your hardware (see "Exporting System Configuration (.CFG) File" (page 162)).

## Software Support

If you have a software problem that is not covered in this guide, please contact Stratasys Customer Support. Contact information is available from the Stratasys website at: <http://www.stratasys.com/customer-support/contact-customer-support>.

When calling in for service, always have your printer's software version (see "Software Version" (page 131)) and printer serial number available (see "Identifying Your Printer" (page 9)). You may also need access to GrabCAD Print to provide a configuration file from your hardware (see "Exporting System Configuration (.CFG) File" (page 162)).

## Safety Instructions

The following basic safety tips are given to ensure safe installation, operation, and maintenance of Stratasys equipment and are not to be considered as comprehensive on matters of safety. The F120 printer is designed to be safe and reliable rapid prototyping printers. Access to areas of the printer are potentially dangerous.

## Hazard Types

Stratasys recommends that all services be performed by qualified personnel. All personnel working on or around the printer should be knowledgeable of what the following hazard classifications mean throughout this guide.

- **Warnings** and **Cautions** precede the paragraph to which they pertain.

 **Warning:**  
Indicates a potentially hazardous situation which, if not avoided, may result in injury or death.

 **Caution:**  
Indicates a situation which, if not avoided, could result in damage to equipment.





- **Notes** follow the relative paragraph.

 Indicates additional information relative to the current topic.

## Product Safety Signs

 Always read and adhere to safety statements, and be aware of the following safety signs when you see them on the printer.

Stratasys makes every effort to ensure that our printers are safe and reliable at all times. However, there will be times when you must access areas of the printer where potentially high voltages, hot temperatures, and/or moving mechanical components could cause severe injury.

Warning Symbols	Meaning	Location	Comments
	Hot surface	Oven	Risk of burns. Do not touch this surface after printing.
	High voltage	Rear Panel and Electrical Panel	Risk of electric shock.
	Gloves	Oven	Safety gloves approved for high temperatures must be worn in locations where this symbol is displayed.
	Moving parts	Oven	Risk of injury from moving parts.

## Product Safety Label Locations

Figure 1: Oven safety label locations

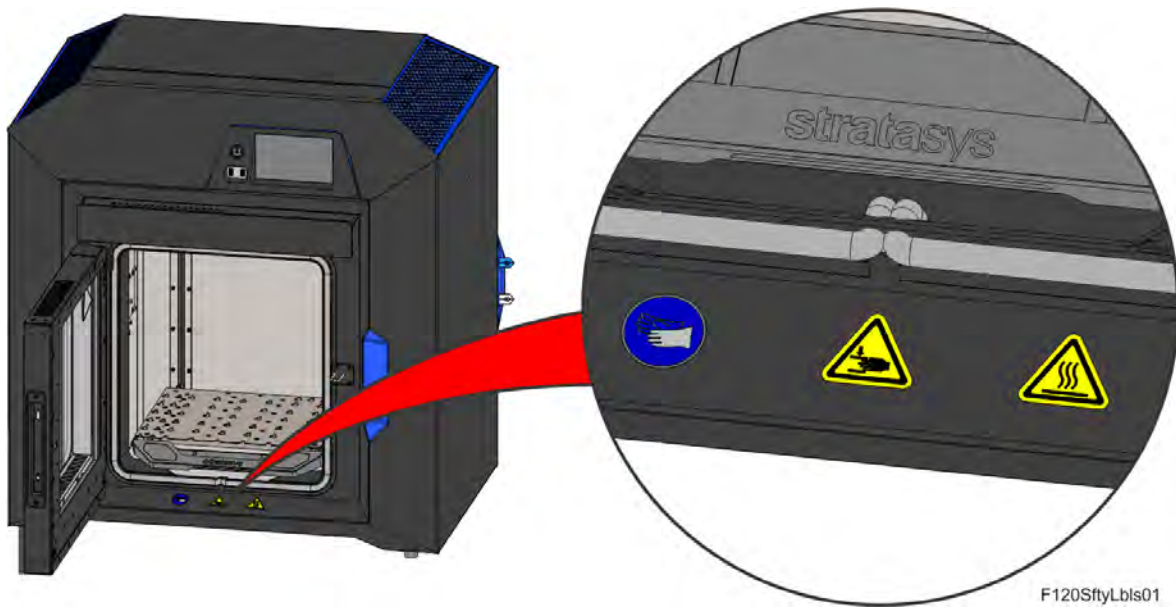

Figure 2: Rear panel safety label locations

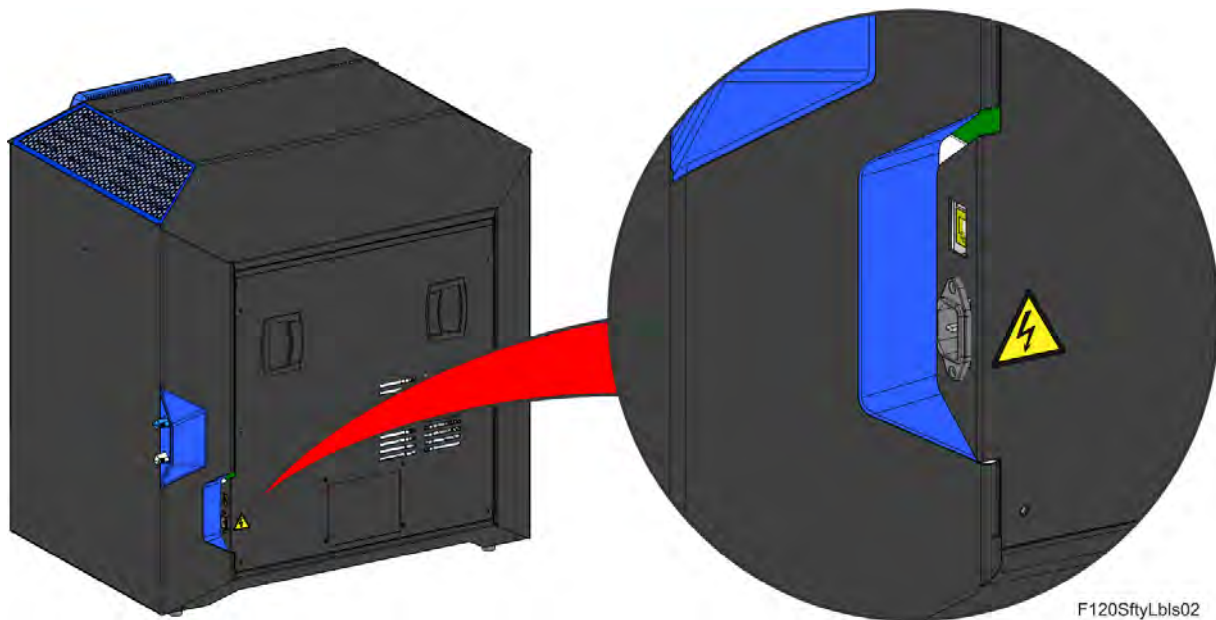
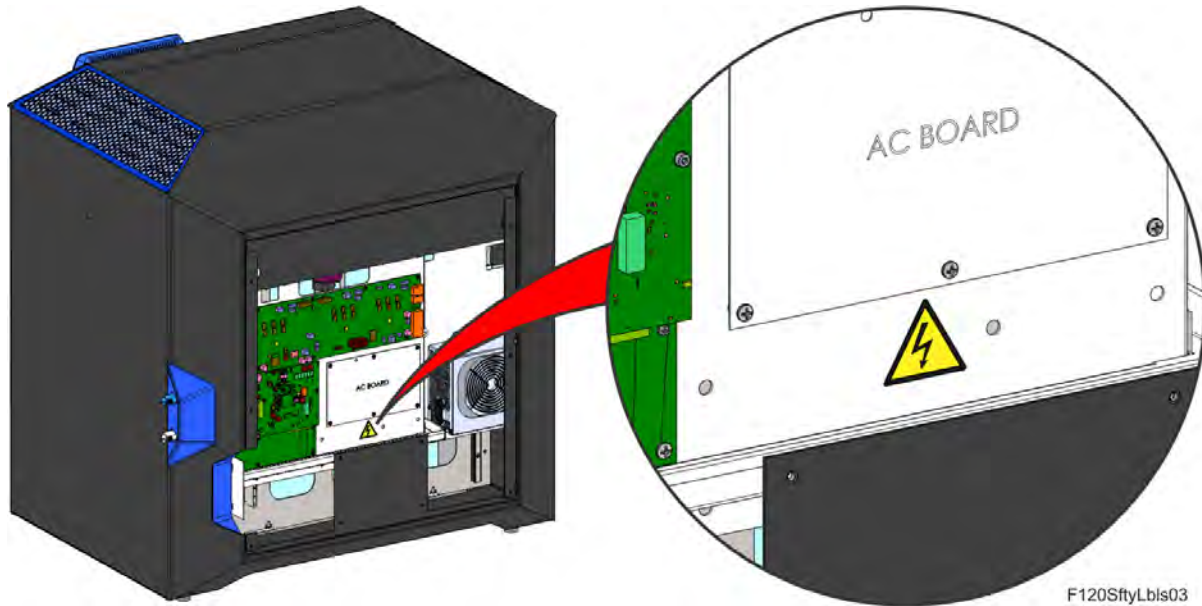

Figure 3: Electrical panel safety label locations



F120SftyLbIs03

## Potential Safety Hazard Areas

The following components and areas of the printer are highlighted as potential safety hazards that may cause system failure or reliability problems if proper safety procedures are not followed.

### Precautionary Statement

Wear protective gloves when handling printed models before they are washed. Sodium hydroxide (caustic soda) may cause chemical burns, scarring and blindness. Mixing it with water generates heat that could ignite other materials. Take adequate safety precautions; use nitrile gloves when handling caustic soda and models soaked in it.

### Oven



**Warning: Hot Surfaces.**

Always wear safety gloves and long sleeves when working inside the oven. Components are hot.



Opening the oven door shuts the oven heaters off.

## Gantry

**Warning: Moving Parts.**

Never wear a tie, loose clothing or dangling jewelry when working around moving components of the printer.

Beneath the top cover of the printer is the gantry. This area houses the mechanical drive components of the X and Y axes. Use extreme caution whenever accessing this area of the printer.



The printer's servo motors are disabled when the oven door and/or top cover are open. The XY pinch hazard between the timing belts and pulleys is minimized by locking the oven door and top cover while building and disabling the motors when the oven door and top cover are open. The oven door and top cover automatically lock when the printer is building and cannot be opened while the printer is building. You cannot start a build if the oven door or top cover are open.

## Z Stage

**Warning: Moving Parts.**

Never wear a tie, loose clothing or dangling jewelry when working around moving components of the printer.

The drive belt, pulleys and Z stage servo motor can cause severe injury. The Z stage crushing hazard is minimized by locking the oven door during Z stage moves and disabling the Z motor when the oven door is open.

## Door Locks

Interlock switches are used to communicate the status of the oven door and the top cover to the printer. For safety reasons, the oven door and top cover must be closed before the X, Y, and Z motors will operate.

## General Safety Practices

Abide by these general safety practices when working with this printer.

**Warning: High Voltage.**

High voltage is present in the printer.

**Warning: Falling Hazard.**

Only use an OSHA or CE approved step stool when accessing the area under the top cover of the printer.

**Warning: Hot Surfaces.**

Always wear safety gloves and long sleeves when working inside the oven. Components are hot.

## Environmental Requirements

- The F120 printer is for indoor use only.
- Air quality conditions with excessive solid particulates (conductive or non-conductive) may result in system damage.
- Air quality conditions in which airborne oils are allowed to accumulate on or within the printer can damage the plastic components.
- System operating temperature shall be in the range of 59°F to 86°F (15°C to 30°C), with relative humidity range of 30% to 70% non-condensing.
- System storage temperature shall be in the range of 32°F to 95°F (0°C to 35°C), with relative humidity range of 20% to 90% non-condensing.
- Altitude shall not exceed 6561.68 feet (2000 m).
- Material storage shall be in the range of 55°F to 86°F (13°C to 30°C), with relative humidity less than 70%.
- Noise emission (acoustic):
  - <32dBA when idle
  - <46dBA when building

# 2 PRINTER SETUP

This chapter describes basic setup of the F120 printer.

## General Information

### Welcome Kit Contents

The printer's Welcome Kit contains the Welcome Insert document and common tools you will need to maintain the printer. Use the following figures and tables to identify the contents of the Welcome Kit.

Figure 1: Welcome Kit Contents - Documents and Cables

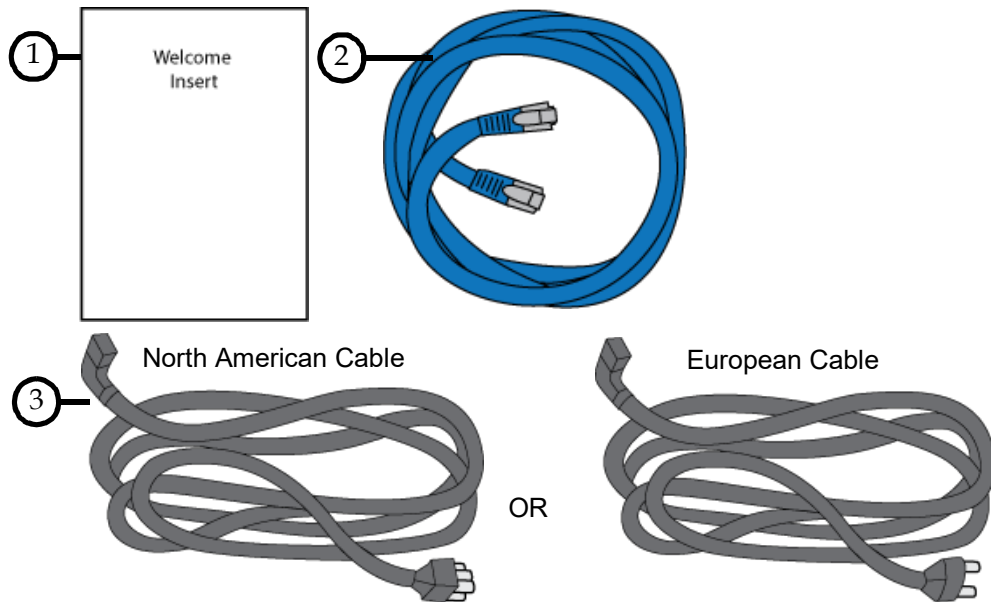

Table 1: Key for Figure 1

#	Item	Description
1	Welcome Insert Document	Contains instructions for downloading the F120 User Guide (this document).
2	RJ45 Cable	This cable is used to establish a network connection between the F120 printer and your Ethernet network. See "Making the Network Connection" (page 9).
3	AC Cable (North American or European)	This cable provides the power connection to the printer. See "Connecting the Power Cable" (page 10). Select the appropriate cable for your location (North American cable or European cable).



Figure 2: Welcome Kit Contents - Tools

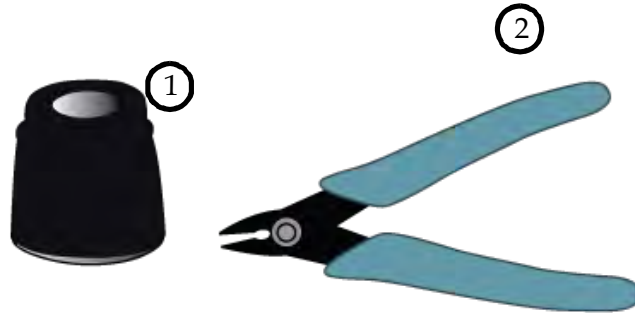

Table 2: Key for Figure 2

#	Item	Description
1	Loupe Magnifier	This tool is included to aid you with performing a Manual Tip Calibration which requires you to view small toolpath relationships. See “Manual Tip Calibration” (page 144).
2	5” Cutter	These are used to cut a material coil box’s filament when unloading and removing materials from the printer. See “Unloading Material” (page 108).

## Basic Setup

Follow the Site Preparation Guide to ensure that your facility is effectively and safely prepared for printer installation. Do not proceed with the following sections until the “Unpacking the Printer” section of the Site Preparation Guide has been completed. When installation is complete, perform the following setup tasks.

- Open the top cover and ensure that the orange clip has been removed from the X belt, and the orange tie wrap has been removed from the X motor. If not, remove the orange clip and/or orange tie wrap securing these components.
- Verify that minimum space requirements have been met.

Table 3: Printer Clearances

Side	Clearance
Right Side Clearance	Minimum 20 inches (50.8 cm)
Left Side Clearance	Minimum 4 inches (10.16 cm)
Rear Clearance	Minimum 6 inches (15.24 cm)
Front Clearance	Minimum 20 inches (50.80 cm)
Overhead Clearance	Minimum 20 inches (50.80 cm)

## Identifying Your Printer

Use the following tags to identify your printer:

- Serial Number Tag - Refer to this number when requesting service. You can also locate the printer's serial number via the Maintenance page of the User Interface (see "System Odometers" (page 88) for more information).
- Model Tag - The printer's model number, part number and power requirements are given on this tag. This tag also lists all patent numbers associated with the printer, some FCC compliance information, voltage warnings, and the Stratasys web address.

Both tags are located on the back side of the printer near the bottom, and are typically placed near the printer's power connection. Use the information on these tags when identifying your printer with Customer Support.

Figure 3: ID Tag Locations

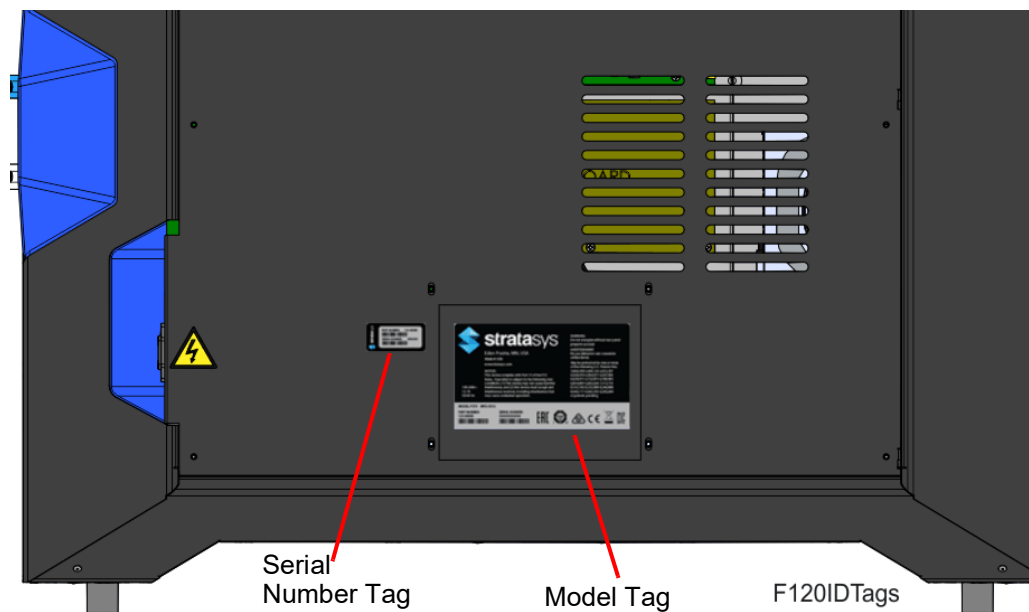

## Making the Network Connection

Processed job files can be transferred from GrabCAD Print to the F120 printer through your facility's Ethernet network. An RJ45 network connector is located on the right, rear corner of the printer (as viewed from the rear). See Figure 4 for the network connection location.



A 15 foot (4'.6m) network patch cable is supplied with the printer and located in the welcome kit. Facilities having network connection points further from the printer than can be reached by the supplied cable are responsible for the procurement of an appropriate cable.

## Connecting the Power Cable

**Caution**

For users in Japan; A power cable is provided for connecting the printer to the AC electric source. Do not use it with other equipment.

To connect the power cable:

1. Connect the male end of the supplied power cord (US or European) directly into a grounded electrical outlet.
2. Connect the female end of the power cord directly into the socket located on the back of the printer (see Figure 4).

**Warning: Electrical Shock Hazard.**

The power cord serves as the disconnect device. The socket outlet must be easily accessible.

Figure 4: Rear Connections

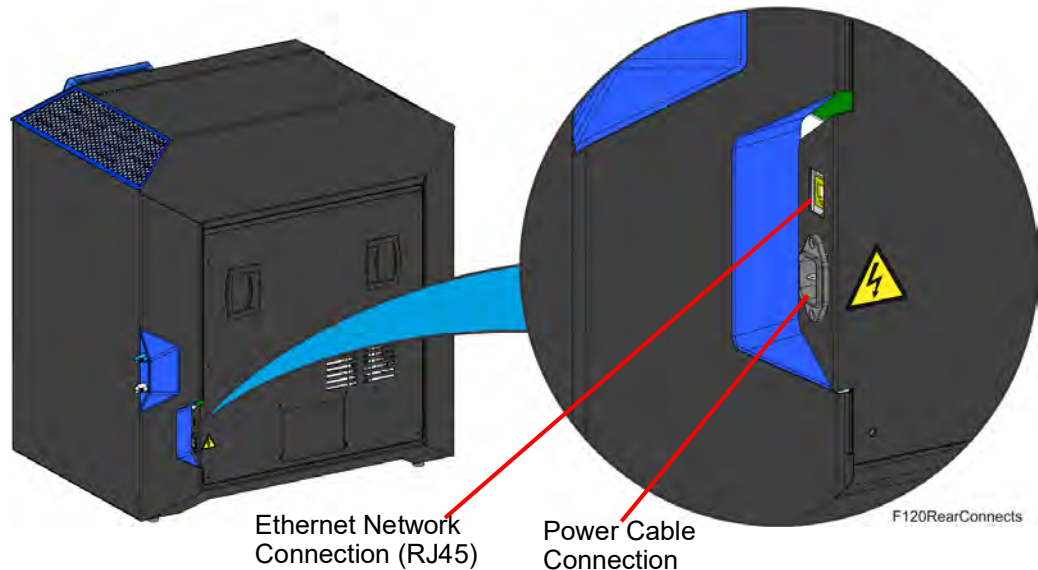

## Configuring the Network

This section is provided in case you need to change your network settings. Within the Network page you can set your printer's address type to Static, Dynamic (DHCP), or Wi-Fi; Dynamic is selected by default.

- Static address - you must enter an IP address, subnet mask, and gateway address for the printer (provided by the system administrator). Once entered, the address will not change.

- Dynamic address (DHCP) - a network server or PC will generate an IP address for the printer. A different IP address may be generated from time to time by the server or PC.
- Wi-Fi address - the printer will scan for and allow you to connect to an available Wi-Fi network (if the Wi-Fi dongle has been installed).

## Network Address Configuration

To configure your printer's network address settings:

1. Power ON the printer, see "Powering ON the Printer" (page 98).
2. Open the Tools page by pressing the **Tools** button within the Navigation Menu (see Table 1 (page 34)).
3. Open the Network page by pressing the **Network** button within the Tools page (see Figure 35 (page 69)).
4. The **Connection Type** row allows you to select between a wired or wireless network. The option selected will determine the configurable settings displayed within the Network page.
  - Selecting the **Wired** option will allow you to select between a Dynamic or Static network mode.
  - Selecting the **Wireless** option will configure the pinter to use a Wi-Fi network. You will need to scan for a wireless network and enter the security settings for the selected network (if required) to complete the configuration. Please note that the availability of the Wireless option depends upon the configuration purchased with your printer.
5. After selecting the radio button corresponding to the connection type you'd like to use (wired or wireless) press the **Back** button in the upper-left corner of the page to return to the Network page.
6. For wired networks:
  - a. The **Network Mode** row will be displayed. Press anywhere within this row.
  - b. Select either the **Static** or **Dynamic** radio button to enable that network address type. Depending on the option selected, you may need to configure additional information within the Network page.

Figure 5: Wired Network Selection

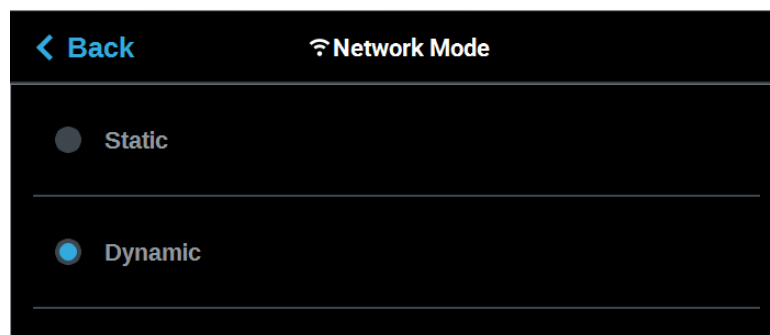

- If the **Static** option is enabled, you must manually configure the IP Address, Subnet Mask, and Gateway Address fields. To configure this information simply touch a field on the screen to select it and then use the keypad displayed to enter address information.

- i. Touch anywhere on the screen outside of the keypad to exit and close the keypad.

Figure 6: Static Network Configuration

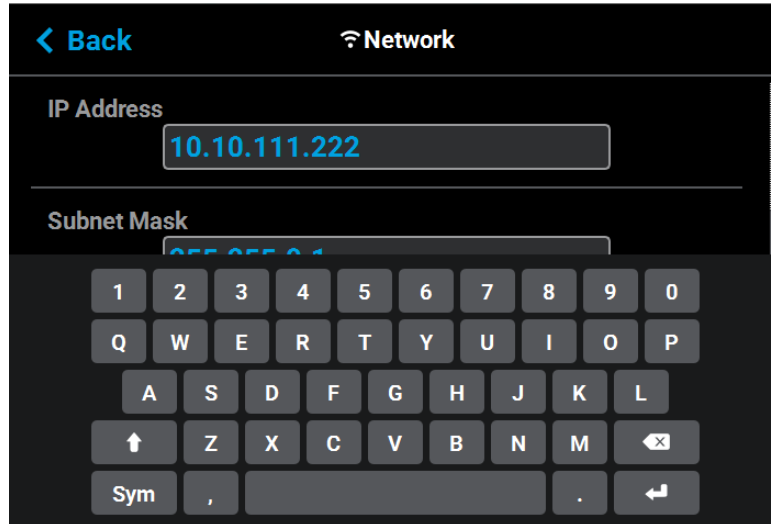

- ii. Scroll to the bottom of the page and press the **Apply** button when finished to save the network configuration.
- iii. Press the **Back** button in the upper-left corner of the page to return to the Network page.

Figure 7: Apply Changes Button



- If the **Dynamic** option is enabled, no additional configuration is necessary as a network server or PC will automatically generate an IP address for the printer. A different IP address may be generated from time to time by the server or PC; the generated IP address will be displayed within the IP Address field of the Network page, and corresponding Subnet Mask and Gateway Address information will also be displayed.

- Press the **Back** button to exit the page and return to the Tools page.

Figure 8: Dynamic Network Configuration

7. For wireless networks:
  - c. The **Available Networks** row will be displayed (Wi-Fi dongle must be installed). Press anywhere within this row.
  - d. Press the **Scan** button; the printer will scan for an available wireless (Wi-Fi) network.

Figure 9: Scan for Wireless Network

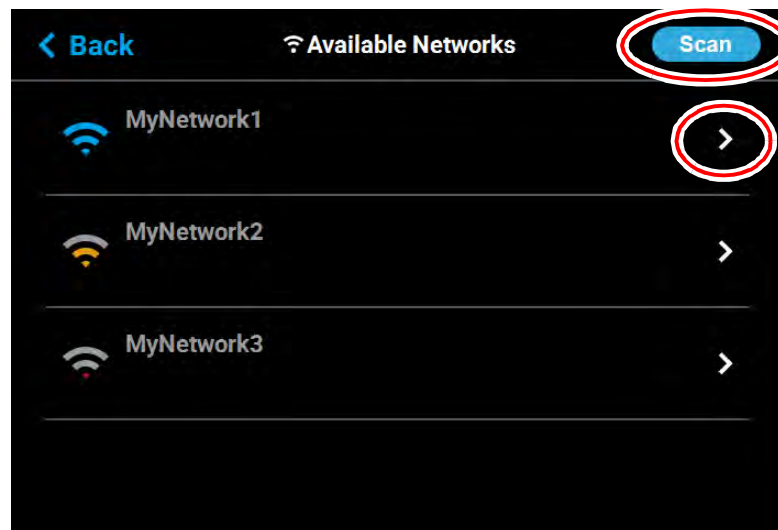

- e. A list of available networks will be displayed; select the wireless network you'd like to connect to by pressing anywhere within the row.

- f. A page will be displayed containing the details of the selected Wi-Fi network. Within this page use the keyboard to enter the password and/or username required to connect to the network.

Figure 10: Enter Wi-Fi Network Information

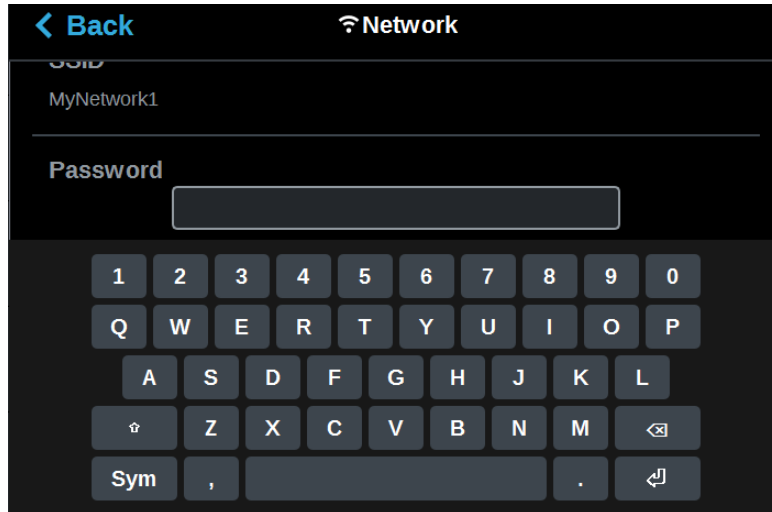

- g. When finished, touch anywhere on the screen outside of the keypad to exit and close the keypad.
- h. Scroll to the bottom of the page and press the **Connect** button to save the network configuration.

Figure 11: Connect Button



- i. Press the **Back** button to exit the page and return to the Network page. The name of the selected wireless network will be displayed within the Available Networks row.

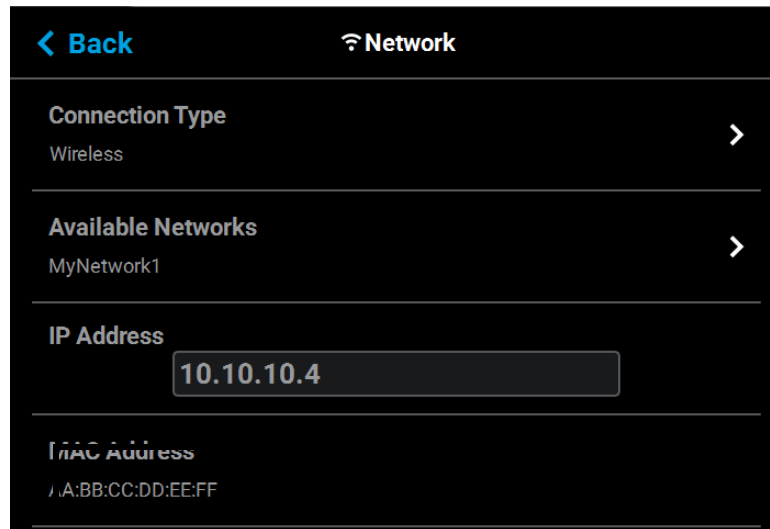

- j. Press the **Back** button to exit the page and return to the *Tools* page. The Network button will refresh and a blue indicator will be displayed indicating that the printer is configured for a Wi-Fi network.

Figure 12: Enter Network Settings Dialog



## Installing GrabCAD Print

Install the GrabCAD Print software on a facility workstation. Navigate to <http://help.grabcad.com/article/197-sign-up-download-and-install> and follow the on-screen instructions. While on the GrabCAD website, be sure to join the F120 User's Group.

## Connecting to the F120 Printer

Add the F120 printer to the GrabCAD Print application. Navigate to <http://help.grabcad.com/article/198-connect-your-printers> and follow the on-screen instructions.



## Setting the Printer's Date and Time



When setting the printer's date and time, the printer must be in an idle state.

In order to ensure accurate build times, the printer's clock must be set correctly. If you find that your printer's date and/or time are incorrect you can update them using GrabCAD Print. To do so, navigate to <http://help.grabcad.com/article/196-printer-firmware-management> and follow the procedure for "Changing your printer's clock time".

## Updating the Controller software Version



When updating the printer's controller software version, the printer must be in an idle state.

Update the Controller Software if necessary. See "Updating Controller Software" (page 158).

## Adjusting the Tip Wipe Height

If necessary, adjust the tip wipe height. See "Tip Wipe Height Adjustment" (page 156).

# 3 SYSTEM COMPONENTS

This chapter describes the components of the F120 printer. Information regarding the materials and tips that can be used by the printer is also included in this chapter.

## Printer Overview

### Access Doors and Panels



Do not energize when the rear panel is not secured in place.

This printer has been designed to allow easy access to the most frequently accessed areas on the system. Doors and panels are highlighted in Figure 1 and Figure 2.

Figure 1: Access Doors and Panels - Front View

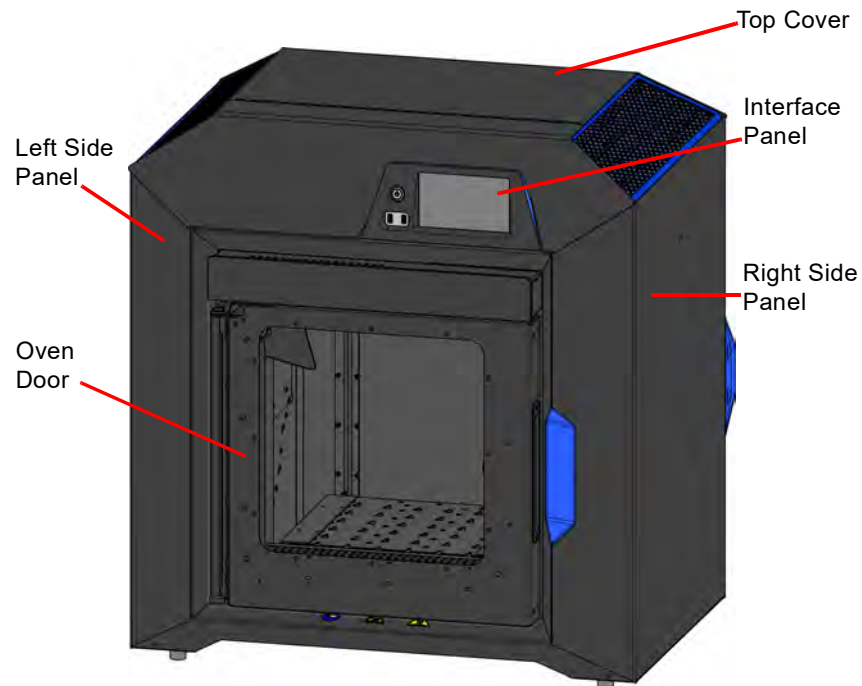
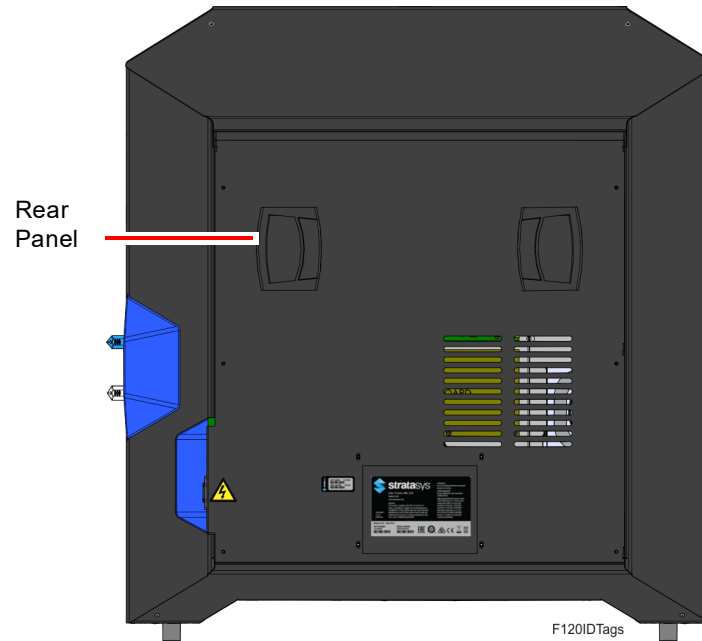

Figure 2: Access Doors and Panels - Rear View



### Top Cover

Allows access to the gantry and head assemblies.

### Oven Door

Allows access to the platen, tip wipe assemblies, purge area, and completed parts for removal. The printer's camera is also housed within the oven door.

### Right & Left Side Panels

The right and left side panels provide access to the oven chamber fans.

### Rear Panel

The rear panel provides access to the electronics bay.

## Interface Panel

The interface panel houses the printer's touchscreen user interface, power button, and USB ports.

Figure 3: Interface Panel

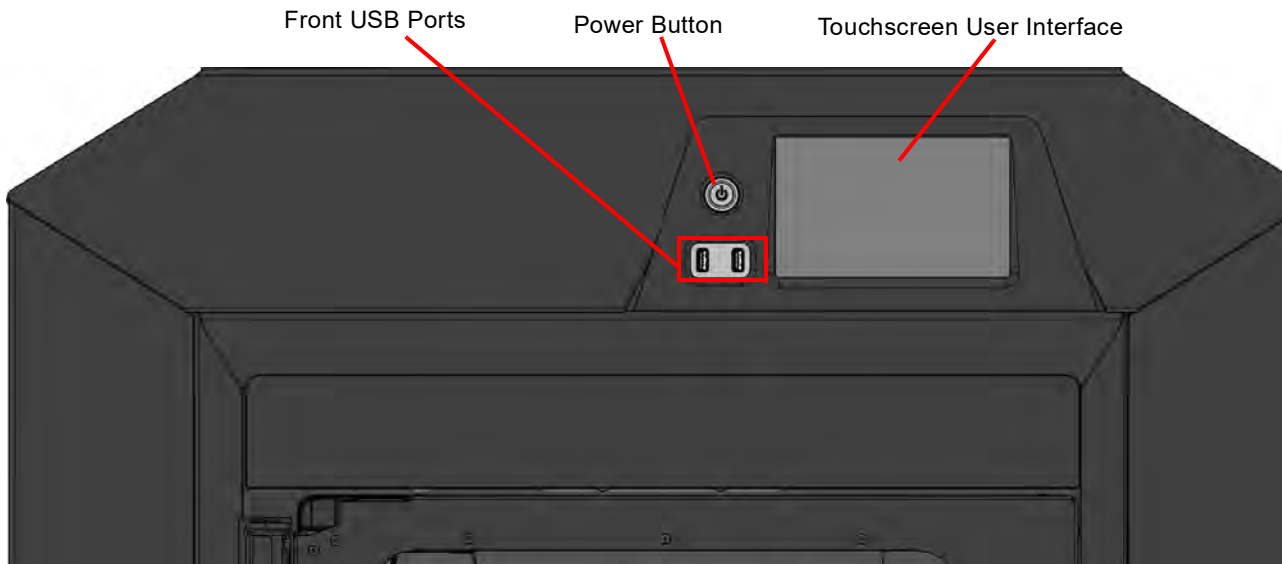

### Touchscreen User Interface

Allows for user control of the printer. From the User Interface you can access various screens to select jobs for building, control jobs in the process of being built, change materials, perform calibrations, and configure your printer's settings and maintenance options. The touchscreen visually displays the operational state of the printer as well as any warning information available.

See [Chapter , 4 User Interface \(page 33\)](#) for detailed information on the components and pages of the User Interface.

### Power Button

Allows you to power the printer ON and OFF (see [“Powering ON the Printer” \(page 98\)](#) and [“Powering OFF the Printer” \(page 99\)](#) for more information).

### USB Ports

The printer's USB ports allow you to easily upload job files to be built. After plugging a USB flash drive into any of the USB ports you can access the flash drive's contents via the Queue page (see [“Working with the Queue Page” \(page 44\)](#) for details).

# Oven Components

The oven consists of the oven door and everything that you see through the oven door window, including the platen, tip wipe assemblies, purge chute, and oven heaters. The printer's camera is housed within the frame of the oven door.

Figure 4: Oven Components

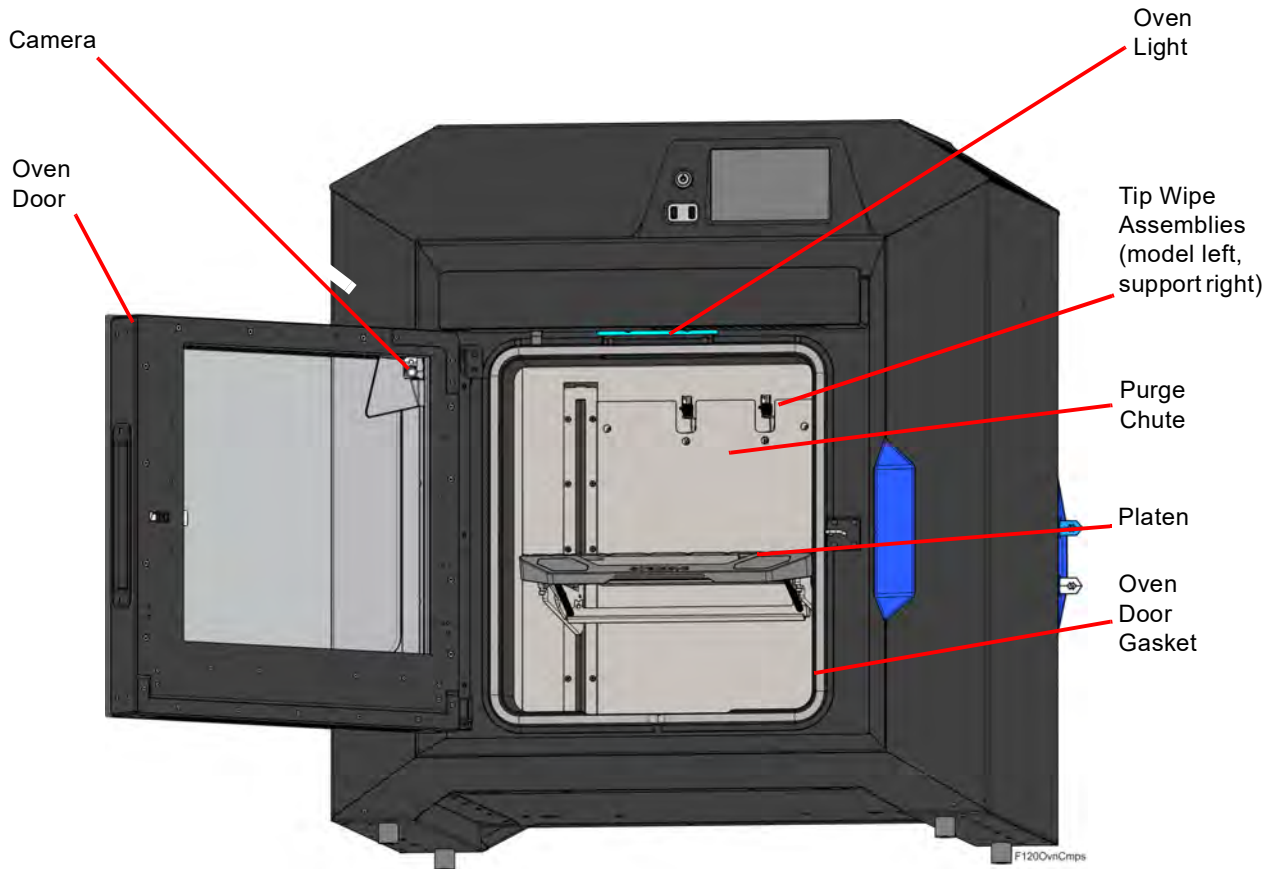

## Oven Door

The oven door (see [Figure 4](#)) utilizes an electromagnetic lock along with optical sensors. The oven door remains locked while the printer is building and automatically unlocks when it is safe for you to access the components of the oven. You cannot open the oven door when the printer is building. The top cover will automatically unlock in conjunction with the oven door, allowing you to manually open the top cover. The oven door must be open prior to opening the top cover. The oven door gasket, which runs around the perimeter of the oven door frame, helps to provide an airtight seal when the oven door is closed.

The oven door window is composed of 2 panes of tempered glass.

## Camera

The printer's camera is housed within the frame of the oven door and provides remote monitoring capabilities while a part is building. Using the GrabCAD Print application installed on your workstation PC, you can view the part as it is building allowing you to remotely monitor part build quality. Pictures are automatically taken at a set interval via GrabCAD Print. Please note that the camera image displayed will include some reflection as a result of the oven door's glass.

Figure 5: Camera Location

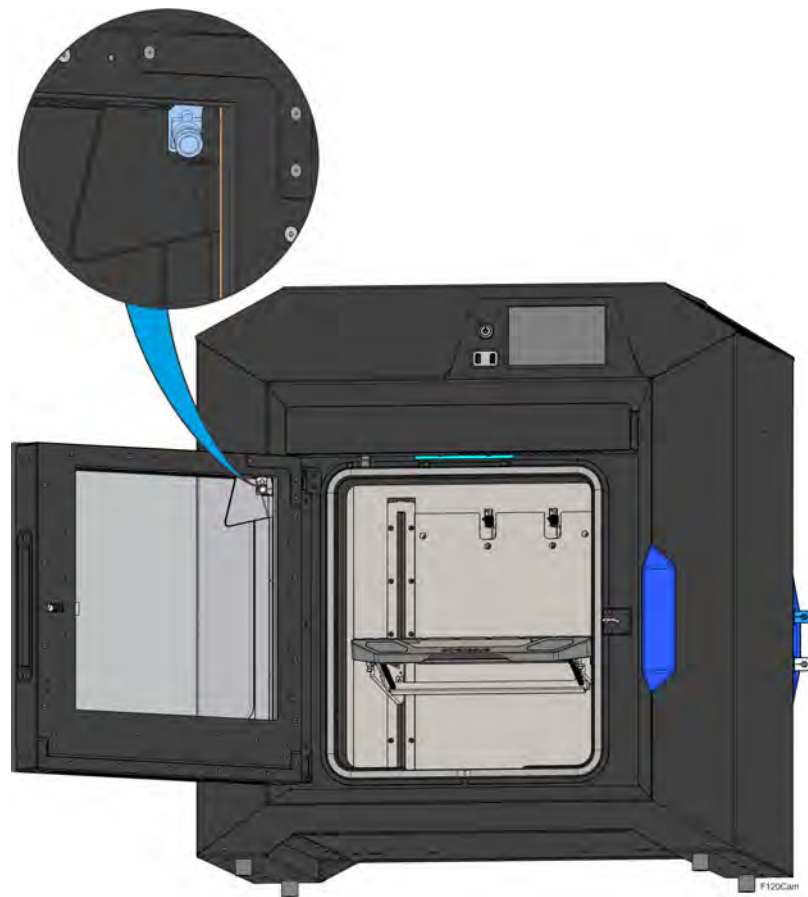

## Oven Light

A single light pipe is mounted on the front upper edge of the oven and is used to illuminate the oven chamber (Figure 6). The light pipe consists of nine high-temperature LEDs; each LED is rated at 1-watt. The oven light is powered by 12 VDC.

The Light button within the Tools page indicates the current state of the oven light and allows you to manually turn the light ON or OFF (see “Light” (page 97)).

Figure 6: Oven Light Location

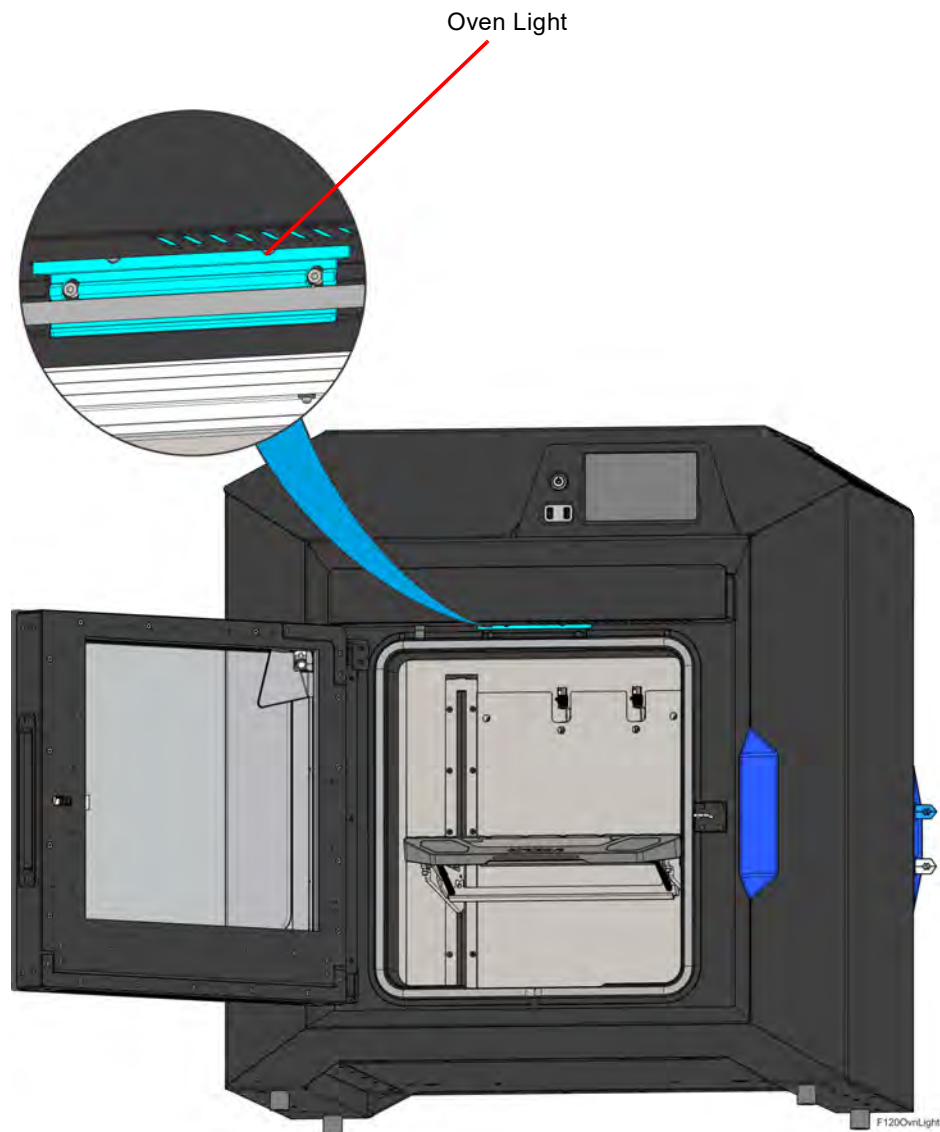

# Platen

The steel platen provides the level surface on which parts are built. A substrate is securely affixed to the platen using the substrate ejection handle. After placing a substrate on the platen lifting up on the handle will lock the substrate into its build position; pressing down on the handle will release the substrate from the platen for removal.

The tip offset calibration targets are located on the rear center portion of the platen. These targets are used when determining the X and Y offset between model and support tips after either head has been replaced (during an automatic Tip Offset Calibration).

Figure 7: Platen Components

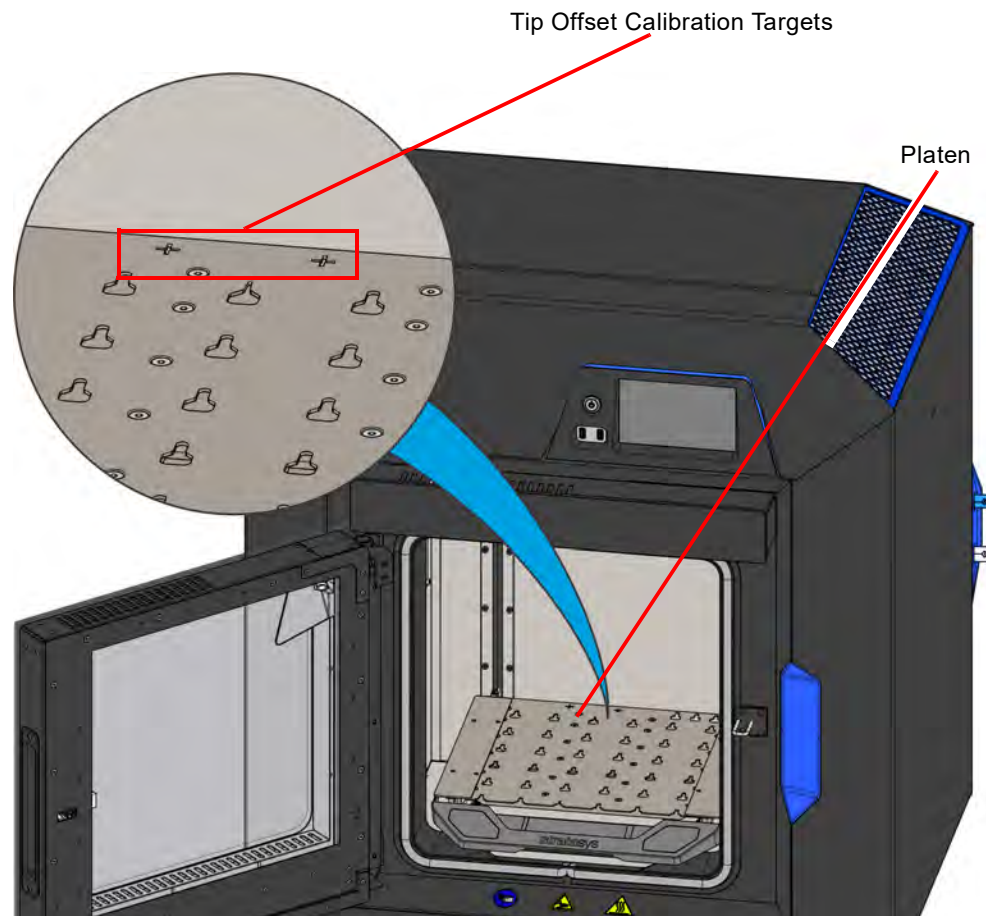



## Tip Wipe Assemblies

Two tip wipe assemblies are located in the rear of the oven, one for model and one for support. Each assembly consists of a flicker and a brush. The tip wipe assemblies keep the printer's tips and tip shields free of purged material debris and material buildup. The tip wipe assemblies are mounted behind the purge chute and extend through the purge chute via two slots cut into the chute's exterior.

After material is purged from a tip, the tip passes across the tip wipe assembly. The flicker cuts the purged material from the end of the tip and knocks it into the purge chute. The brush cleans the tip and tip shield. Purged material debris is guided down from the tip wipe assemblies to the bottom of the oven chamber via the purge chute.

Figure 8: Tip Wipe Assemblies

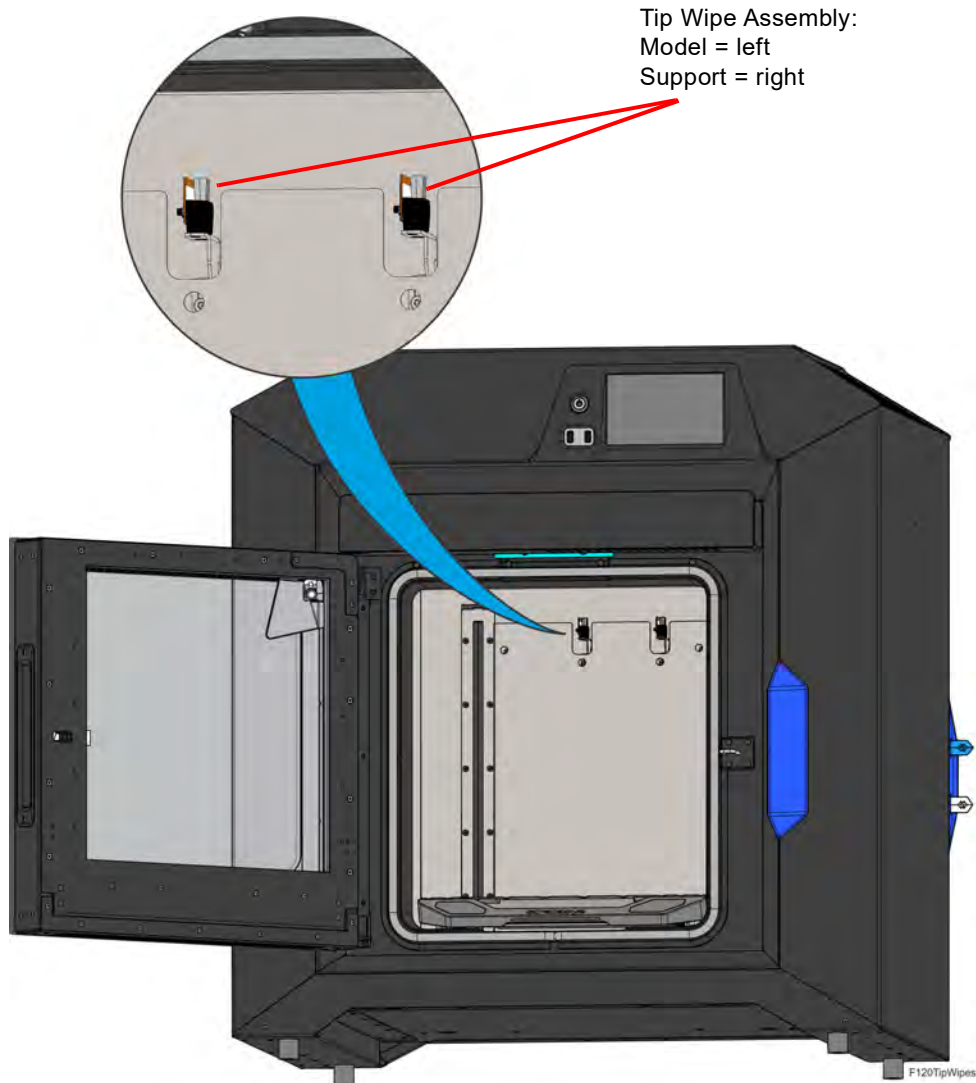

# Purge Chute

The purge chute is located in the back of the oven. Purged material debris is guided down from the tip wipe assemblies to the bottom of the oven chamber via the purge chute. Material debris exits the purge chute via an opening at the bottom of the chute and then accumulates in the bottom of the oven chamber. Accumulated material debris should always be cleaned on a weekly basis, or as needed if excessive accumulation occurs, see “Cleaning the Oven Chamber” (page 167) for instructions.

Figure 9: Purge Chute Location

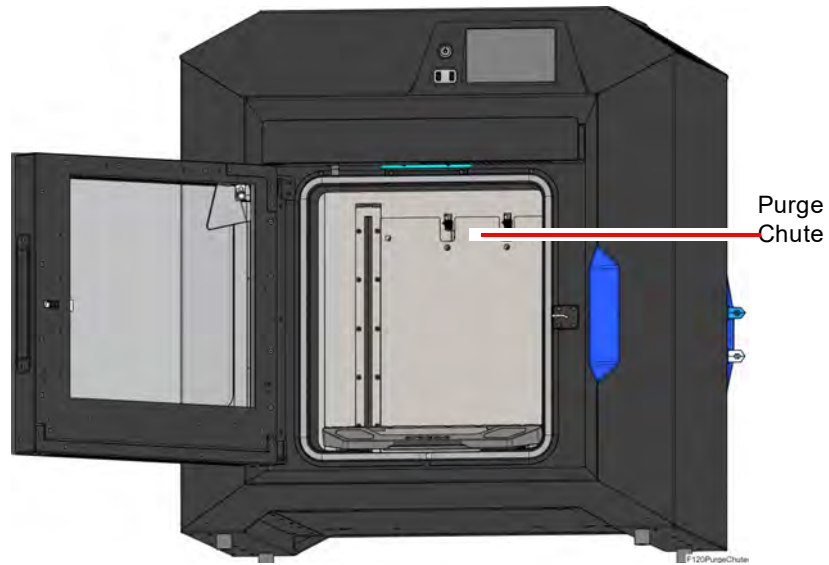
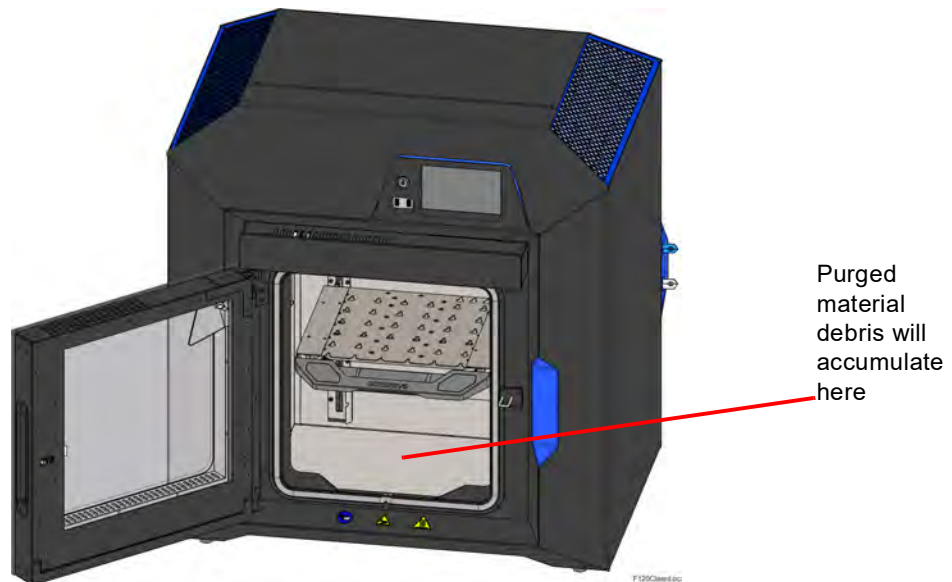

Figure 10: Oven Chamber Cleaning Location



## Material Coil Box

The F120 printer uses a material coil box (Figure 11) to supply both model and support material to the printer. The material coil box is external to the F120 printer and must be manually loaded to one of the printer filament ports (Figure 11). Each material coil box has a filament key which interfaces with the system at the filament port. Within each filament port is a filament key reader chip which interfaces with the filament key to communicate each material coil box's material type and the quantity of material within the box. The F120 require two material coil boxes: one for model material and one for support material.

Figure 11: Material Coil Box and Material Port

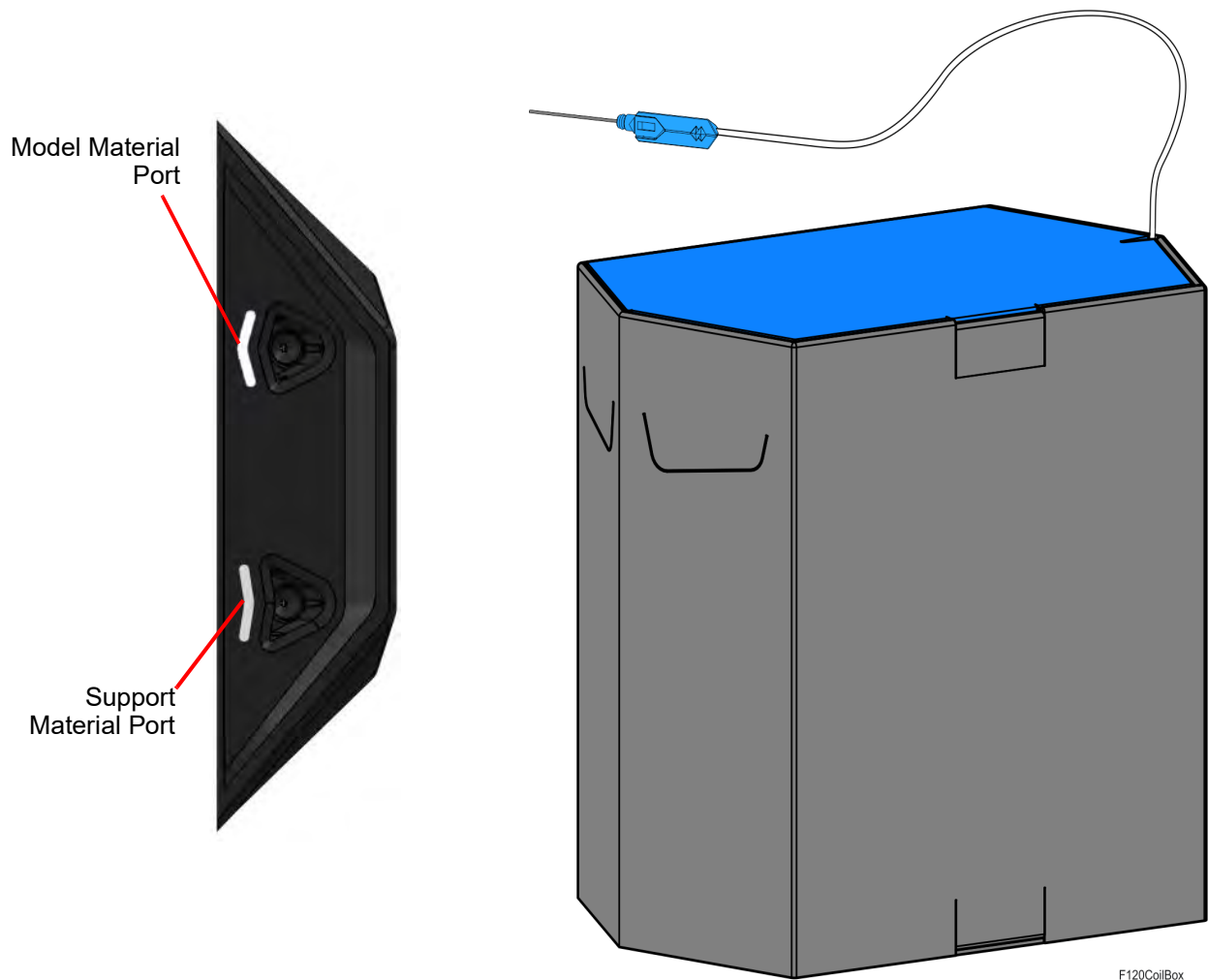

# Gantry

To access the gantry or the heads, you must first open the top cover. The top cover utilizes a mechanical locking mechanism. The top cover remains locked while the printer is building and automatically unlocks when the oven door is opened. The printer cannot resume building if the top cover and/or oven door are open.

The gantry moves the head in the X and Y directions when building a part. The gantry assembly is located under the top cover. The entire gantry is outside of the oven; only the bottom of the head protrudes into the oven. The gantry and its drive motors are thermally shielded from the oven via flexible heat shields. To move the head, the gantry utilizes one X and two Y servo motors attached to timing belts.

Figure 12: Gantry Assembly

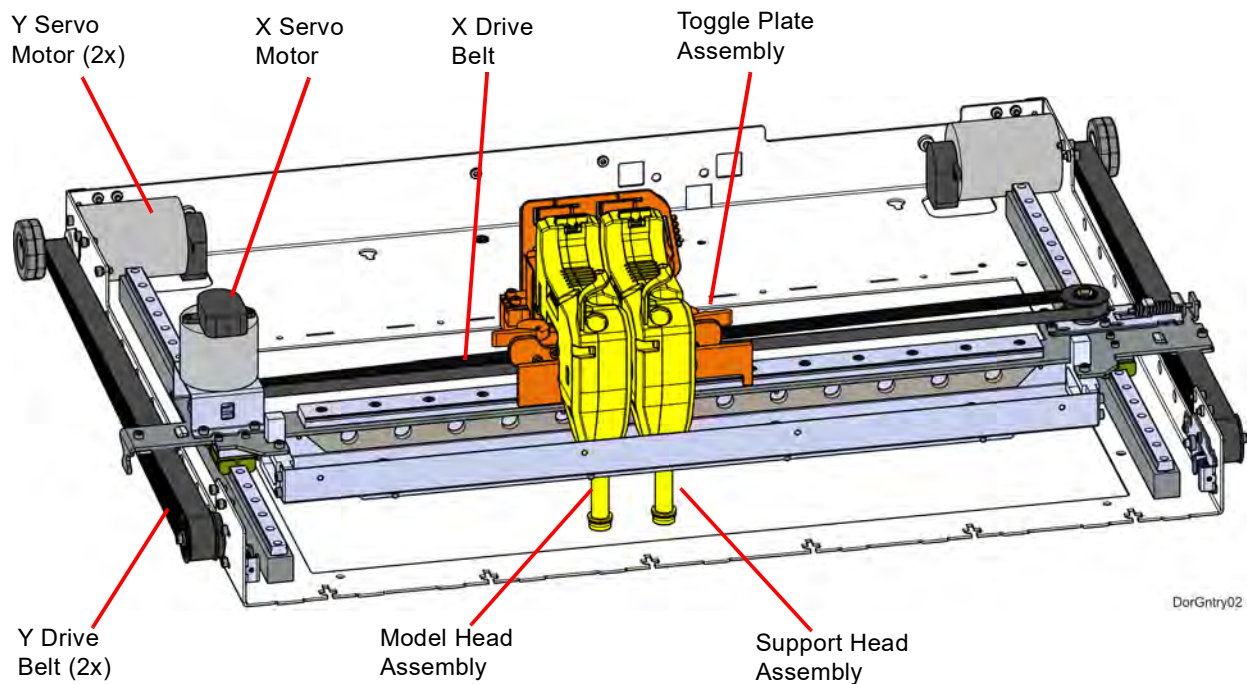

## Print Heads

The F120 printer utilizes one print head assembly for model and support material. The model and support heads are black. Once a head has been used for model or support, it can only be used for that designated material (model or support) thereafter. The heads are designed for use with a range of modeling materials. The heads extrude model material and support material with two identical liquefiers. A single blower fan, mounted above the tip liquefier entrances, cools the incoming material at the liquefier entrances.

Head life is directly related to the amount of build time for the head. Heads are a replaceable consumable item and should be changed once the head's odometer reaches 1500 build hours (see "Viewing Head Details" (page 56) for information on head odometers). You will receive a warning when the head's odometer reaches 1350 build hours, reminding you to order a

replacement head as the head is nearing its odometer limit. You can continue using a head which has exceeded its odometer limit, but it is highly recommended that you change the head as part quality will be unpredictable. The corresponding Head Status Icon will be displayed in its warning state on the User Interface (see Table 6 (page 54) for icon states). The entire model or support head assembly is replaced as a single unit (see “Head Replacement” (page 111) for instructions). The Head Release Lever locks and unlocks the associated head into or out of its seated position.

Figure 13: Head Assemblies

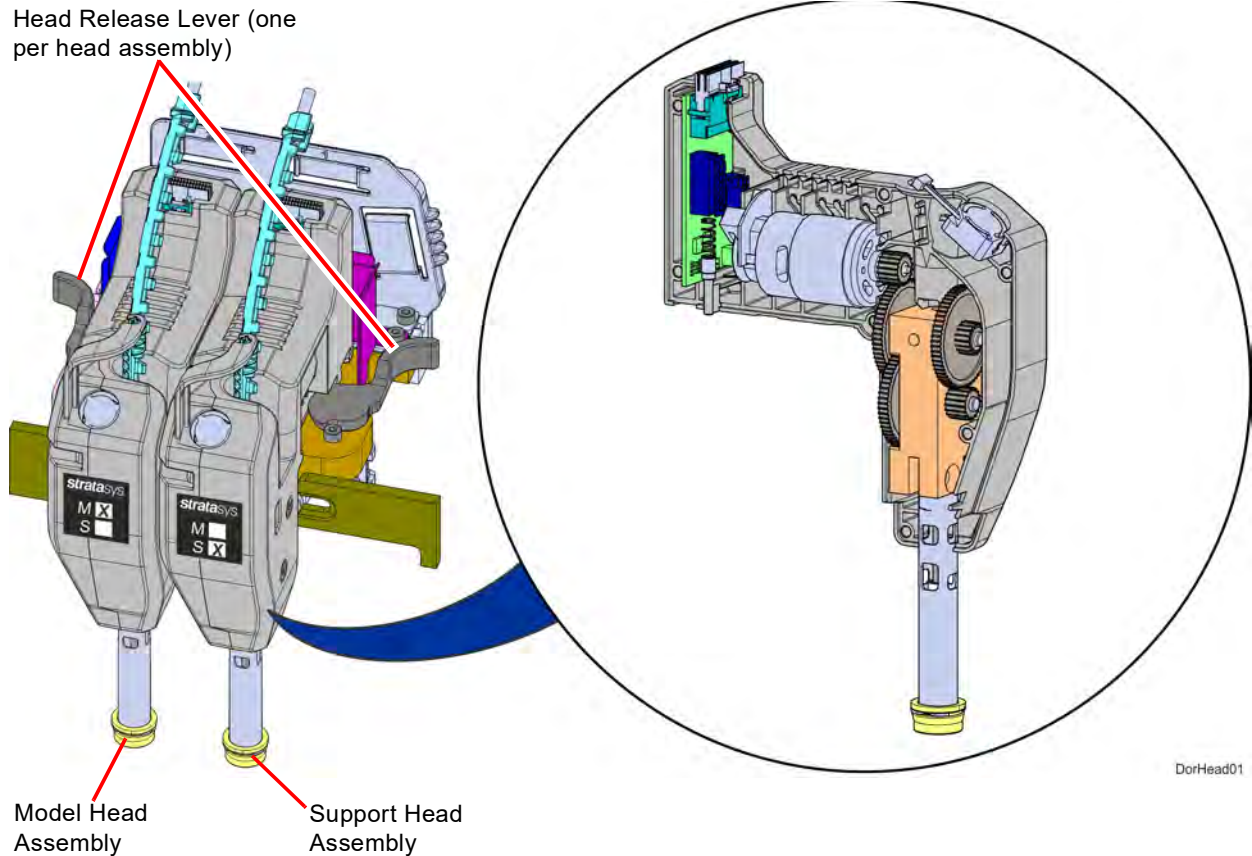

## Modeling Materials

### Materials Used

The F120 printer can use ABS and ASA modeling materials. SR30 Soluble Release support material is used in conjunction with all model materials. See Table 3 (page 31) for model and support compatibility information.

Table 1 (page 29) lists the material types available for use with each printer model.

Table 2 (page 29) lists color availability by model material type.

Table 1: Available Materials

Printer Model	Available Materials
F120	ABS and ASA

Table 2: Color Options

Material Type	Color Options
ASA	Ivory
ABS	Black

## Material Coil Box Memory Chip

Each material coil box has a memory chip; this memory chip recognizes the box’s material type and tracks the box’s volume. The F120 printer utilizes a different memory chip than other Stratasys materials and as a result, only F120 printer compatible material coil boxes can be used to build parts on the printer.

Figure 14: Material Spool Memory Chip Location

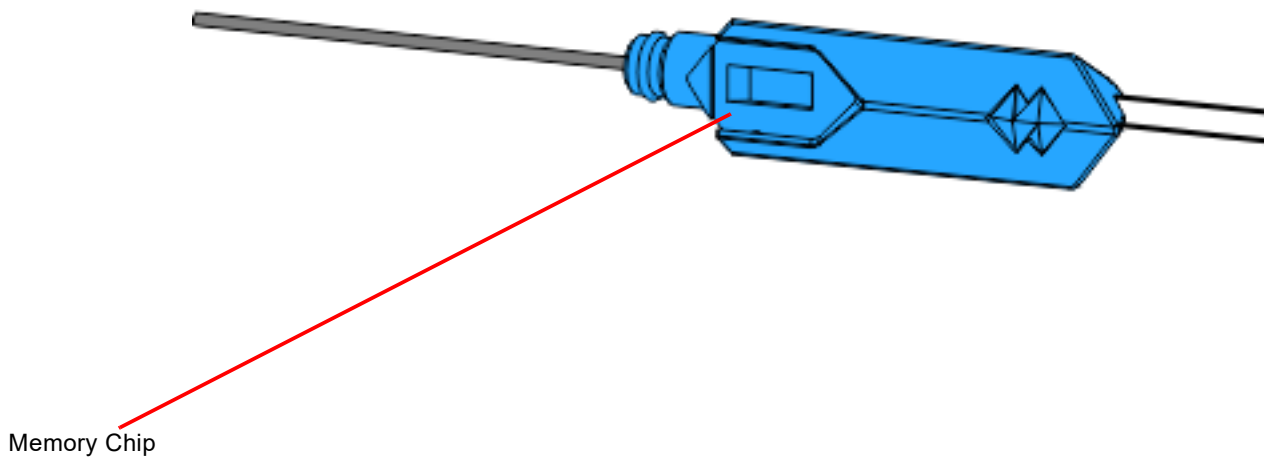

When a material coil box is connected, its memory chip is read and the box’s information is reported to the printer. The material coil box’s material type and volume are displayed within the Materials page of the User Interface (see “Working with the Materials Page” (page 53) for more information). If a non-compatible material coil box is connected, an error will be displayed on the User Interface.

Each build file contains an estimate of the amount of model and support material required to complete the build. When initiating a build, this estimate is compared to the amount of material available on each material coil box. If there is not enough material available to complete the build, you will be warned and given the option to change material coil boxes before starting the build.



A specific prompt will only be displayed if a material coil box volume related issue is detected. See “Warnings and Errors” (page 205) for details.

## Tips and Slice Height

The F120 utilizes a T14 tip for all model and support materials. Tips are a component of the associated head assembly and cannot be changed individually. Instead, the entire head assembly is replaced as a single unit.

Table 3 (page 31) lists the types of model material available for use with the printer and their corresponding support material.

Table 4 (page 31) lists available slice heights.

Table 3: Available Material Types

Model Material	Support Material
ASA	SR30
ABS	SR30

Table 4: Slice Height

Model Tip	Slice Height (in)	Slice Height (mm)	Material
T14	0.007	0.178	ABS, ASA
	0.010	0.254	ABS, ASA
	0.013	0.330	ABS, ASA



# Software

## Controller Software

Controller Software is installed during the manufacturing process, and can be updated as new versions become available (see “Updating Controller Software” (page 158) for instructions). Controller Software is the software used to control the printer.

## GrabCAD Print Software

The printer builds parts by processing an original CAD or STL file into a Stratasys CMB file which is then downloaded to the printer. GrabCAD Print is the software used to process files and then transfer them to the printer to be built. As part of the initial installation and setup process, you must download and install GrabCAD Print software. You must download this software before you will be able to build a part on the printer. To download GrabCAD Print navigate to <http://help.grabcad.com/article/197-sign-up-download-and-install> and follow the on-screen steps.

Jobs are sent to the printer in CMB format and placed into the Job Queue (see “Working with the Queue Page” (page 44) for information on the Job Queue.) The header of the CMB file contains the processed job’s basic information.

The GrabCAD Print Help documentation includes detailed information on how to connect to your printer, process parts, edit the Job Queue, etc. The Help file can be accessed from either the application’s Help Menu or directly from the GrabCAD website.

# 4 USER INTERFACE

This chapter provides an overview of the F120 printer's User Interface (UI). Specific printer operation information and procedures can be found in [Chapter , 5 Operating the Printer](#) (page 98). You must power ON the printer prior to using the touchscreen, see "Powering ON the Printer" (page 98) for instructions.

## Overview

The User Interface is composed of a touchscreen located on the front right face of the printer (see [Figure 1](#)). Each page of the UI is composed of two main areas of functionality; these items are highlighted in [Figure 1](#).

Figure 1: User Interface Overview

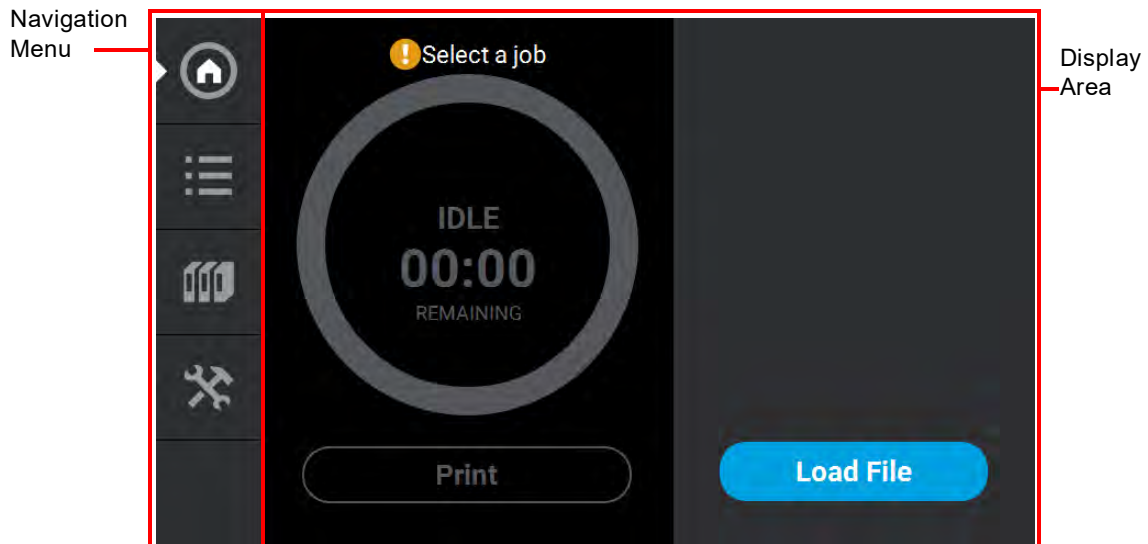

The touchscreen is designed to reduce glare; therefore, it is best to view the touchscreen when standing in front of the printer with the screen to your right. Viewing the touchscreen from any other angle may inhibit a clear view of the screen's display. The touchscreen is easy to use and allows you to:

- Access material load, unload, and calibration functions.
- Monitor printer status.
- Monitor material/head statuses (types loaded/installed, material coil box volumes, head odometers, etc.) and change materials and/or heads when necessary.
- Monitor build progress (name of job being built, materials usage information, estimated completion time, etc.).
- Access network configuration information and change printer defaults.
- Access the Job Queue and Sample Queue (internal storage).

## Navigation Menu

The Navigation Menu provides one-touch access to the Build, Queue, Materials, and Tools functions of the printer (see Figure 1 for details). The User Interface is broken up into several pages of related functionality. Selecting a button from the Navigation Menu will open the button's corresponding page, allowing you to perform tasks within that page. If a page contains sub-pages, additional buttons corresponding to these items will be displayed within the page's Display Area.

The buttons in the Navigation Menu are mutually exclusive, meaning only one button may be selected at a time. In some cases, a notification badge will be displayed within the button indicating a warning related to the functionality of the corresponding page. Buttons can appear as follows:



The bottom-most button in the Navigation Menu is non-functional.

Table 1: Navigation Menu - Button States

Button Name	Selected State	Unselected State	Warning State		Error State	
			Unselected	Selected	Unselected	Selected
Build Button						
Queue Button			N/A	N/A	N/A	N/A
Materials Button					N/A	N/A
Tools Button			N/A	N/A	N/A	N/A

After selecting a button from the Navigation Menu, a white indicator arrow is displayed along the left-center edge of the button. This arrow indicates which Navigation Menu item is currently selected, making it easy for you to recognize which page of the UI you are viewing.

Figure 2: User Interface Overview

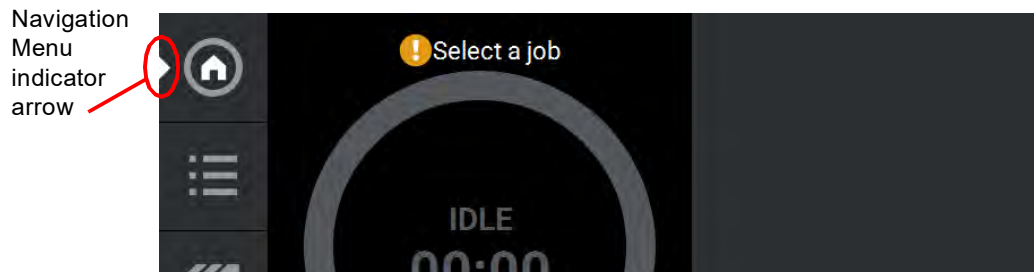

## Display Area

The Display Area contains the body portion of each page of the User Interface; this is where you can select from available functions and view current status. After selecting a button from the Navigation Menu, the Display Area will refresh and the main page corresponding to the selected button will be displayed. The information and buttons/icons shown within the Display Area will vary depending on which main page of the UI was selected.

## Working with the Build Page

The Build page is composed of the three main areas of functionality that are necessary for building parts on the printer; these items are highlighted in [Figure 3](#). Within the Build page you can start, pause, and abort a job, view a build time estimate for the selected job, see status and estimated action points for a job in progress, and view a visual representation of the completed part. Please note that you must load a job file to the printer and select the file to be built before the job's details will be displayed within the Build page.

The Build page also contains the Notifications Display. Depending on the state of the printer a variety of notifications/warnings will be displayed within this area of the page. Touching the text on the screen will open a dialog indicating the reason(s) for the notification, and in some cases, steps to correct the notification (see [Figure 4](#)). Once all notifications have been corrected, press the **Close** button within the dialog to exit the dialog.

To access the Build page, press the **Build** button within the Navigation Menu; a screen similar to the one in Figure 3 will be displayed.

Figure 3: Build Page

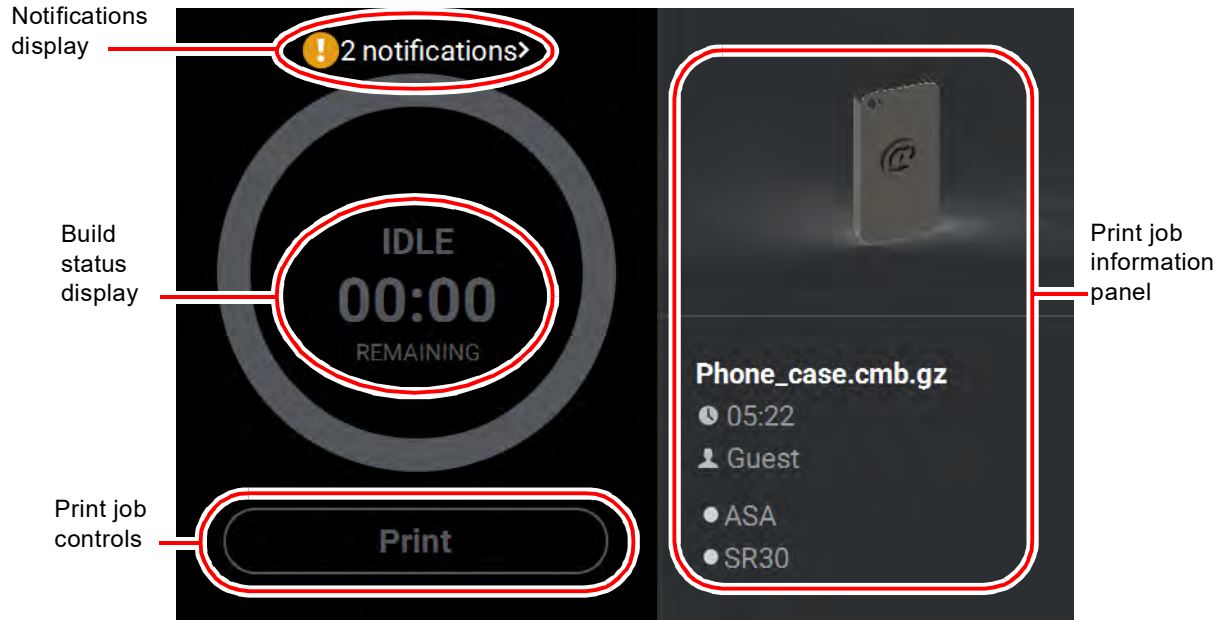
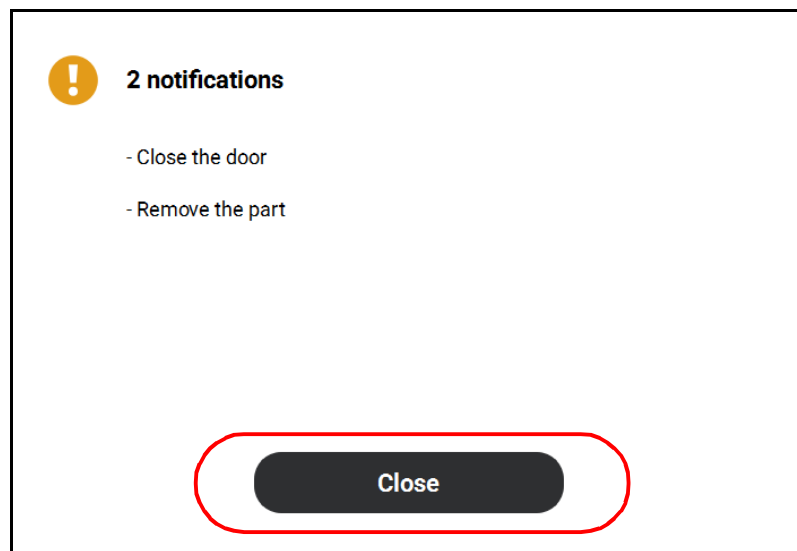

Figure 4: Notification Details



## Loading a File



A job file must be loaded onto the printer and selected for building before the job's details will be displayed within the *Build* page.

The Print Job Information Panel is empty upon initial startup and the *Build Status Display* reflects its idle state. When there are no job files available within the Job Queue, the *Load File* button will be displayed within the *Build* page. Visibility of this button is dependent upon the method used to load job files to the printer.

A job must be selected for building before the job's details will be displayed within the *Build* page. In order to build a job, you must first load the job's corresponding job file to the printer. Job files can be loaded via network transfer (Ethernet or Wi-Fi) using the GrabCAD Print application on your workstation PC or by plugging a USB flash drive into one of the printer's USB ports and navigating to the job file via the *Queue* page (see "Adding a Job to the Job Queue" (page 45) for details). The job file you wish to build must be the first item listed in the *Job Queue*. Job files can be sorted as needed within the *Queue* page allowing you to select the job you'd like to build (see "Editing the Job Queue" (page 49) for details).

- If you send a single job file to the printer via network transfer using GrabCAD Print, the job's details will automatically be displayed within the *Build Status Display* once the job file is received by the printer, as this job will be the only item in the Job Queue. The *Load File* button will be hidden from view once the job file is received by the printer via network transfer.
- If you send two or more job files to the printer via network transfer using GrabCAD Print, the job details of the first file sent will automatically be displayed within the *Build Status Display* once the job file is received by the printer, as jobs are built in the order they're sent to the printer. The *Load File* button will be hidden from view once the first job file is received by the printer via network transfer.
- If you do not send files to the printer using GrabCAD Print and instead plug a USB flash drive into one of the printer's USB ports, the *Load File* button will be visible within the *Build* page. You can use this button to select a single job file you'd like to build directly from the flash drive.



The Load File button within the Build page allows you to quickly select a single file to build off of a USB flash drive. The selected file will automatically be queued for building. If you'd like to populate the Job Queue with multiple job files, follow the instructions within "Adding a Job to the Job Queue" (page 45).

To load a file:

1. Plug a USB flash drive into one of the available USB ports on the front of the printer (see Figure 3 (page 19) for USB port locations).

2. Press the *Load File* button within the *Build* page.

Figure 5: Load File Button

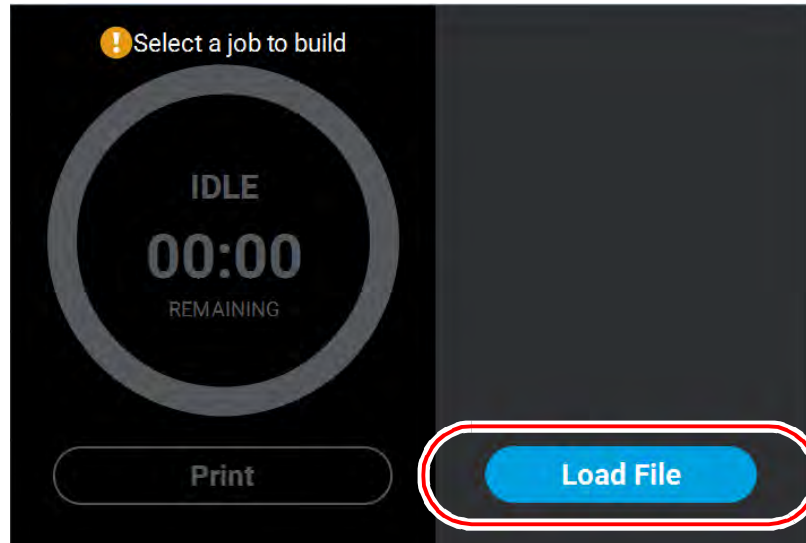

3. The *Load File* page will be displayed; press the *USB* button within this page.

Figure 6: Load File Page - USB Option

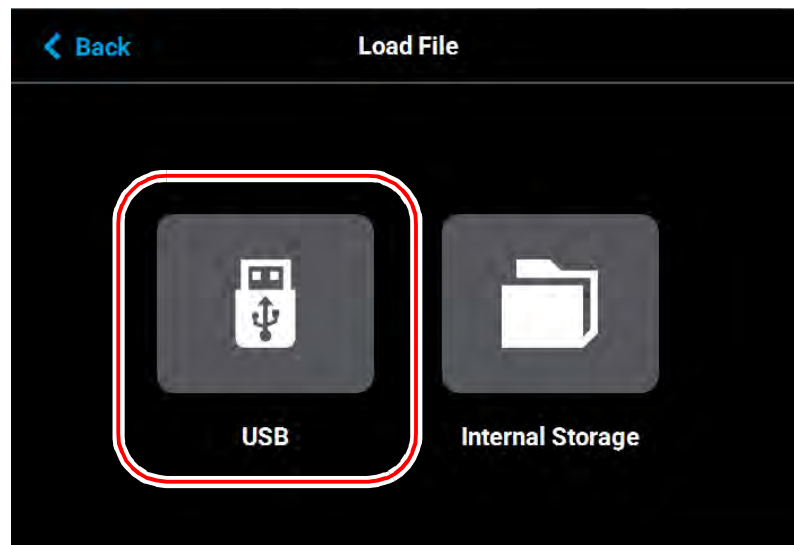

4. The *Load File* page will display the contents of the USB flash drive. Locate the desired job and select it by touching its row on the screen; doing so will open its *Job Details* page.



If both USB ports contain a flash drive individual folder graphics will be displayed on the screen representing each flash drive and its contents. Touching the folder graphic on the screen will drill down into the folder and display its contents. If a single flash drive is installed the job files located on the flash drive will be displayed in individual rows.

5. Within the Job Details page press the **Add to Queue** button; this will load the job into the Job Queue.

Figure 7: Add File to Queue

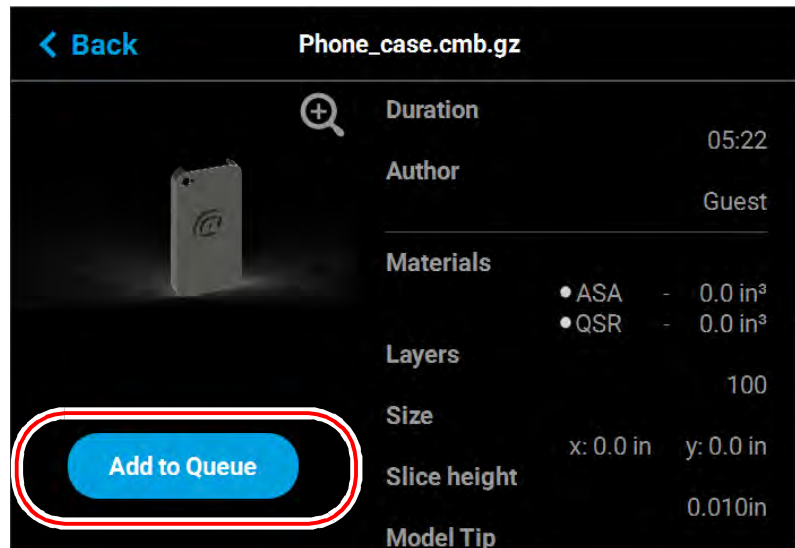

6. After pressing the *Add to Queue* button you will be returned to the *Build* page. The *Load File* button will no longer be visible. Instead, the details of the selected job file will be displayed within the Print Job Information Panel.
7. Pressing the *Print* button within the *Build* page will initiate the build. Build progress will be displayed within the Build Status Display, see “Build Status Display” (page 41) for details.

Figure 8: Build Page with Job Information

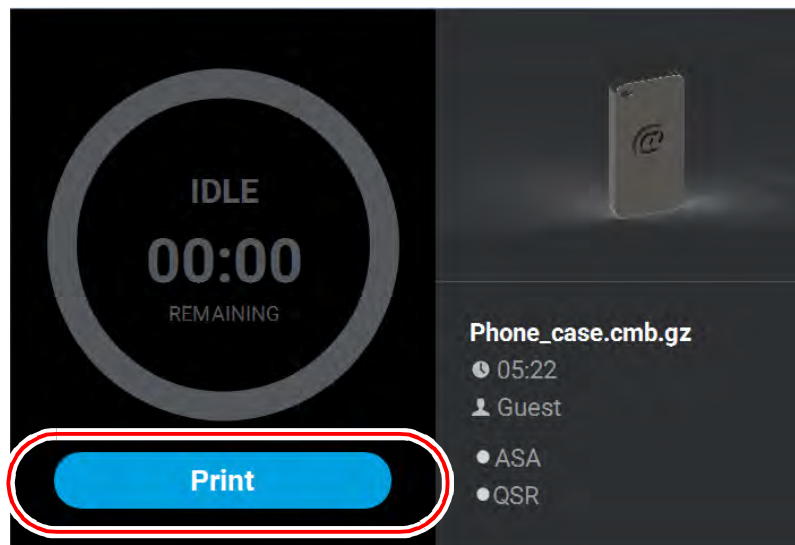



## Viewing Print Job Information

Information pertaining to a selected job is displayed within the right half of the *Build* page, within the Print Job Information Panel. This information is static and represents the details of the job file.

Figure 9: Print Job Information Panel

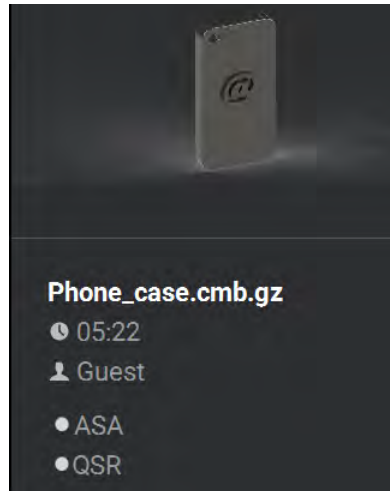

Information displayed within this panel is divided into the two sections:

The top-most section displays a visual representation of what the selected job will look like after it is successfully built.

The bottom-most section displays a variety of information pertaining to the selected job, including:

- Name of the job.
- Estimated build time for the job.
- Name of the user that submitted the job.
- Model and support materials associated with the job.

Touching anywhere within this portion of the screen will open a page displaying additional details pertaining to the selected job (see “[Viewing Job Details](#)” (page 50)).

## Build Status Display

The Build Status Display section of the Build page is composed of a two-part graphic. The center portion provides information on a selected and/or building job while the outer progress ring corresponds with the build information displayed; the information displayed will vary depending on the state of the printer.

Figure 10: Build Status Display Overview

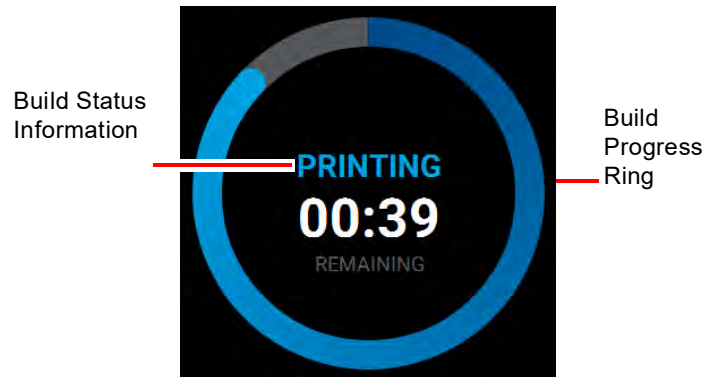

### Idle

When the printer is idle, "IDLE" will be displayed within the center of the Build Status Display. This indicates that the printer is in a state where it is ready to start a build. No progress is indicated within the outer build progress ring and the time remaining is displayed as zero.

Figure 11: Build Status Display - Idle



## Building



A job file must be loaded onto the printer and selected for building before build information will be displayed within the Build Status Display. See “Loading a File” (page 37) for details.

After pressing the **Print** button to start a build, "PREPARING" is briefly displayed within the Build Status Display, and the outer progress ring will fill, in gray, in a clockwise direction. This indicates the amount of time the printer requires to prepare for the start of the build, including the amount of time required for a Z Zero Calibration to occur (see “Z Zero Calibration” (page 156) for details).

Once build preparation is complete, "BUILDING" will be displayed within the center of the Build Status Display along with the amount of time remaining until the build is complete. As build progress is made, the amount of time remaining will get smaller until zero is reached, indicating that the build is complete. The build's percentage of completion is also displayed by radially filling in the outer progress ring, in blue, in a clockwise direction.

Figure 12: Build Status Display - Building

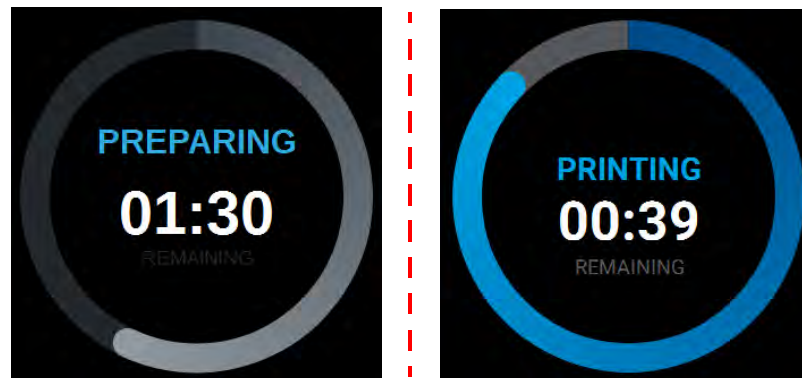

Touching the screen within the center of the Build Status Display while a part is being built will toggle the information displayed. After touching the screen the time estimation information will be hidden from view and instead the Build Status Display will show the number of completed layers as compared to the total number of layers in the build. Touching the screen again, will toggle back to the time estimation information displayed initially.

## Print Job Controls

A button is displayed within the Build page, just beneath the Build Status Display. This button is used to start, pause, or abort a build, depending on the status of the printer. The Print button option will become selectable after you’ve performed the steps necessary to load a file (see “Loading a File” (page 37)) and the printer is in a state where it is ready to build a part. This button will toggle to display the Pause and Abort button options when a build is in process.

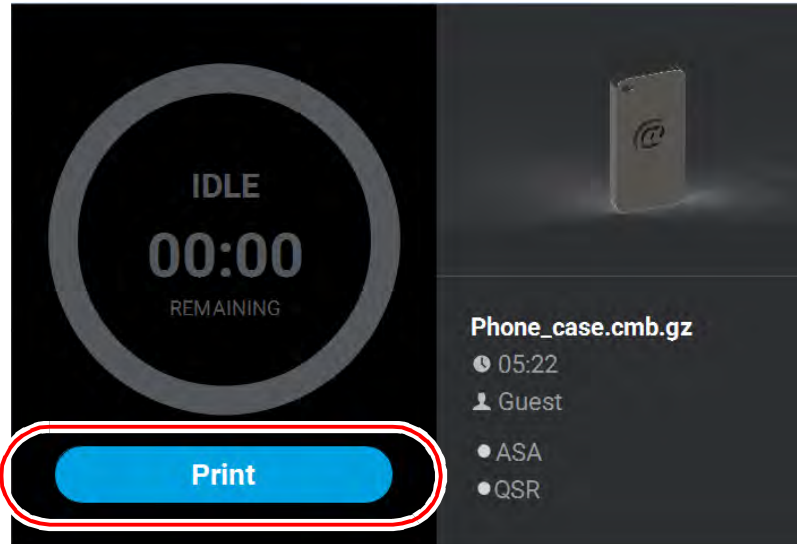

Figure 13: Print Job Controls



### Print Button

The Print button allows you to start a build (see “Selecting a Job to Build” (page 115) for more information). The Print button can appear in the following states:



Table 2: Print Job Controls - Print Button States

Button State	Description
	<ul style="list-style-type: none"> <li>Printer is in a buildable state AND a selected job is available to build.</li> <li>Selecting the Print button will begin the build.</li> </ul>
	<ul style="list-style-type: none"> <li>Print button is disabled and not selectable.</li> <li>Printer is not in a buildable state OR a job is not selected/available to build (i.e. queue is empty).</li> <li>To troubleshoot this issue, touch the text displayed on the screen within the Notifications Display. This will open a dialog allowing you to view the reason(s) for the current build state, including any issues impeding your ability to start a build (i.e. no substrate, etc.). See “Warnings at Build Start” (page 206) and “Errors Preventing a Build from Starting” (page 207) for more information.</li> </ul>

## Pause Button

The Pause button allows you to pause an active build. The Pause button can appear in the following states:



Table 3: Print Job Controls - Pause Button States

Button State	Description
	<ul style="list-style-type: none"> <li>Printer is actively building. Selecting the Pause button in this state will pause the build.</li> <li>When the printer is paused, "PAUSED" is displayed within the Build Status Display.</li> </ul>
	<ul style="list-style-type: none"> <li>Pause button is disabled and not selectable.</li> <li>Printer is preparing for a build, there is no job currently building on the printer.</li> </ul>
	<ul style="list-style-type: none"> <li>Printer is paused. The Pause button toggles to display the Play button.</li> <li>Selecting the Play button will resume the build.</li> <li>If the build was automatically paused as the result of an error, a notification will be indicated on the screen. Touching the notification text displayed will provide additional details pertaining to the current build state. See "Build Warnings" (page 117) and "Build Pause Warnings" (page 211) for more information.</li> </ul>

## Abort Button

The Abort button allows you to abort an active build. The Abort button can appear in the following states:

Table 4: Print Job Controls - Abort Button States

Button State	Description
	<ul style="list-style-type: none"> <li>Printer is actively building.</li> <li>Pressing the Abort button in this state will initiate an abort of the build and will display a prompt asking you to acknowledge the abort. <ul style="list-style-type: none"> <li>If accepted, the build will be aborted.</li> <li>If canceled, the build will be unaffected (i.e. revert to its previous state).</li> </ul> </li> </ul>
	<ul style="list-style-type: none"> <li>Abort button is disabled and not selectable.</li> <li>There is no job currently building on the printer.</li> </ul>

# Working with the Queue Page

The Queue page contains the list of files (jobs) which have been downloaded to the printer and are queued for building; this list is referred to as the Job Queue. By default, jobs are added to the Job Queue in the order they were sent to the printer via GrabCAD Print and/or transferred from a USB flash drive. Individual jobs are listed in numbered rows with row one corresponding to the first job in the Job Queue. Each row displays the name of the job, estimated build time

for the job, and name of the user that submitted the job. From the Queue page you can add files to the Job Queue, select a file to build, sort jobs within the Job Queue, view additional details associated with a selected job, and access the Sample Queue.

To access the Queue page, press the **Queue** button within the Navigation Menu; a screen similar to the one in

Figure 14 will be displayed. Please note that the Job Queue is empty upon initial startup.

The heading of the Queue page lists the number of jobs currently loaded into the Job Queue. Up to three jobs are displayed within the Job Queue list at a given time. If the Job Queue contains more than three jobs, use the scrollbar (to the right of the Job Queue list) to scroll up or down through the list of available jobs.

Pressing the **Edit** button within the heading of the page will display the Job Queue Control buttons; these buttons allow you to sort and /or delete the jobs within the Job Queue as needed. Pressing the **Load File** button within the heading of the page will allow you to add additional files to the Job Queue. Touching one of the rows listed within the Job Queue will open that job's Job Details page; this page contains additional information pertaining to the selected job (material configuration, tip size, etc.). After selecting either of these buttons or opening a job's details page a "Back" button will be displayed within the heading of the page; press this button to return to the main Queue page.

Figure 14: Queue Page

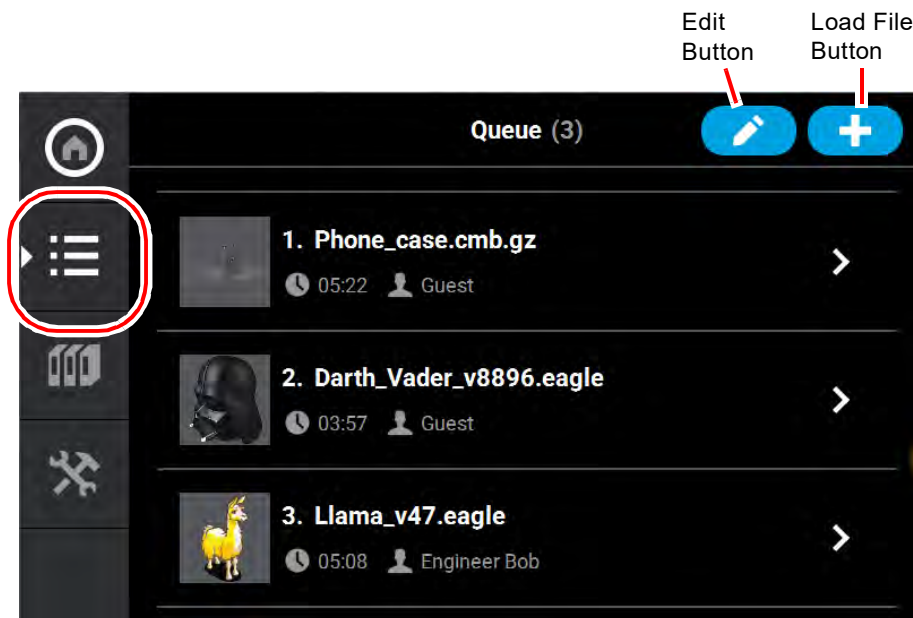

## Adding a Job to the Job Queue

The Job Queue is empty by default. To populate the Job Queue you must first load individual job files to the Job Queue using one of two methods:

1. Network transfer via the GrabCAD Print application on your workstation PC. See “[GrabCAD Print Method](#)” (page 46) for detailed instructions. This is the preferred method for adding jobs to the Job Queue.
2. USB method via a USB flash drive inserted into one of the available USB ports on the front of the printer. See “[USB Method](#)” (page 46) for detailed instructions. This method can be used as a backup to the GrabCAD Print method if you are unable to transfer job files to the printer via your Ethernet connection (due to poor connectivity, a network outage, etc.) or Wi-Fi connection. This method also provides a convenient option for you to reprint a common job, as you can store the processed job file on the USB flash drive and access it repeatedly.

## GrabCAD Print Method

As part of the printer’s installation and setup process, you should have downloaded and installed the GrabCAD Print application onto your workstation PC (see “[GrabCAD Print Software](#)” (page 32) for details). GrabCAD Print is the software used to process job files and then transfer them to the printer (via your facility’s Ethernet connection or via Wi-Fi) to be built.

Jobs are sent to the printer in CMB format and are placed directly into the Job Queue. No additional steps are required to add a job to the Job Queue when sending job files directly to the printer via GrabCAD Print. After sending the job file to the printer navigate to the Queue page by pressing the **Queue** button within the Navigation Menu. The transferred job file will be displayed within the Job Queue list. Jobs will appear within the Job Queue in the order they’re sent to the printer from GrabCAD Print. To build a specific job, that job must be listed as the first item in the Job Queue. You can sort jobs within the Job Queue as needed to select the job you’d like to print (see “[Editing the Job Queue](#)” (page 49) for details).

## USB Method

The printer features three USB ports. A USB flash drive can be inserted into any of these ports and job files contained on the flash drive can be added to the Job Queue. Please note that job files should be processed using GrabCAD Print before they are placed onto the flash drive and subsequently added to the Job Queue. Once the flash drive is plugged into one of the printer’s USB ports, you will need to perform the following steps to add the desired job file to the Job Queue:

3. Plug a USB flash drive into one of the available USB ports on the printer (see [Figure 3](#) (page 19) for USB port locations).
4. Navigate to the Queue page by pressing the **Queue** button within the Navigation Menu.

5. Press the **Load File** button in the upper-right corner of the touchscreen.

Figure 15: Load File Button Location

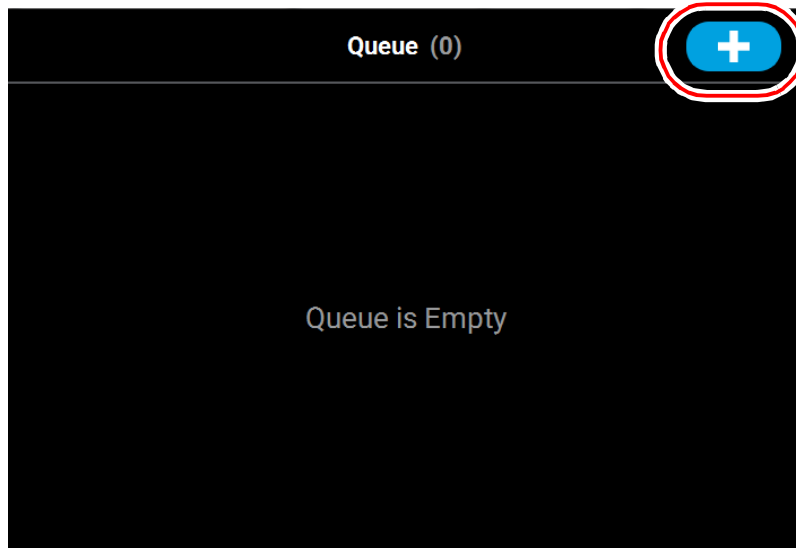

6. The Load File page will be displayed; press the **USB** button within this page.

Figure 16: Load File Page - USB Option

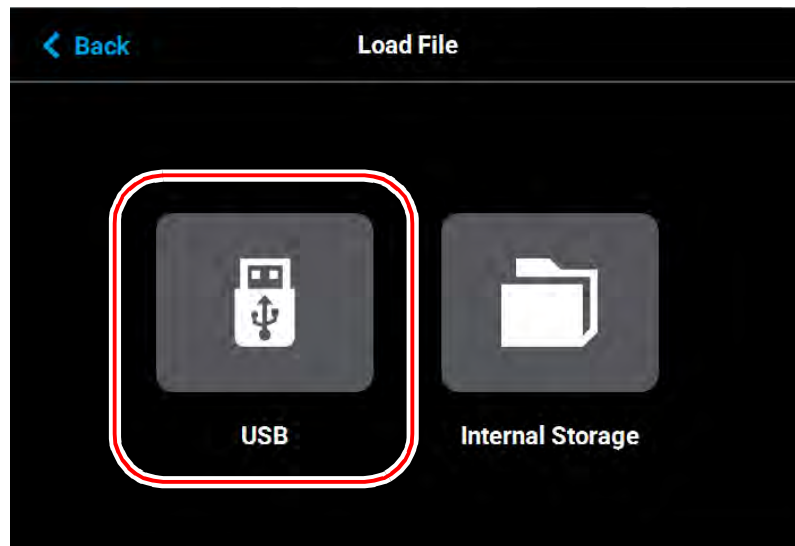



7. The Load File page will display the contents of the USB flash drive. Locate the desired job and select it by touching its row on the screen; doing so will open its Job Details page.

 If any USB port contain a flash drive, individual folder graphics will be displayed on the screen representing each flash drive and its contents. Touching the folder graphic on the screen will drill down into the folder and display its contents. If a single flash drive is installed the job file(s) located on the flash drive will be displayed in individual rows.

Figure 17: Select File to Load



8. Within the Job Details page press the **Add to Queue** button; this will load the job into the Job Queue.

Figure 18: Add File to Queue

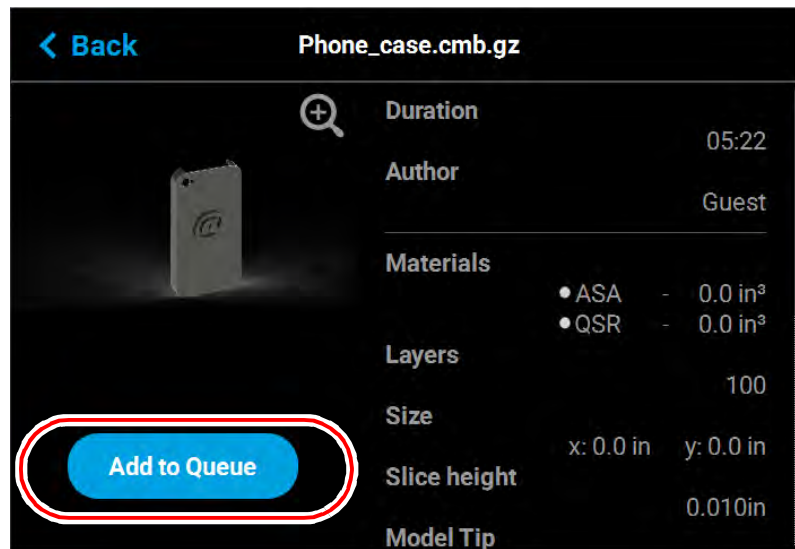

- 9. The file will load into the Job Queue. Once loading is complete the file will be added to the Job Queue list.

Figure 19: File Loading to Job Queue

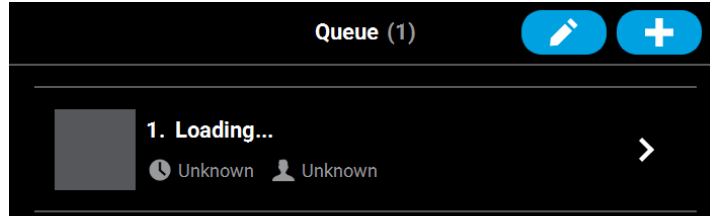
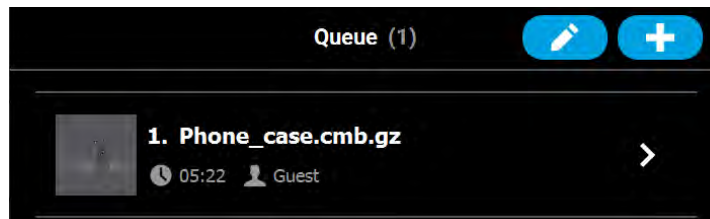

Figure 20: File In Job Queue



## Editing the Job Queue

By default, jobs are built in the order in which they appear within the Job Queue. To build a specific job, that job must be listed as the first item in the Job Queue. Pressing the **Edit** button within the Queue page will open the Edit Queue page. Using the Job Queue Control buttons found within this page you can sort and /or delete the jobs within the Job Queue as needed, to ensure the job you wish to build is the first item listed within the Job Queue.

Pressing the **Back** button will allow you to exit the Edit Queue page and return to the main Queue page.



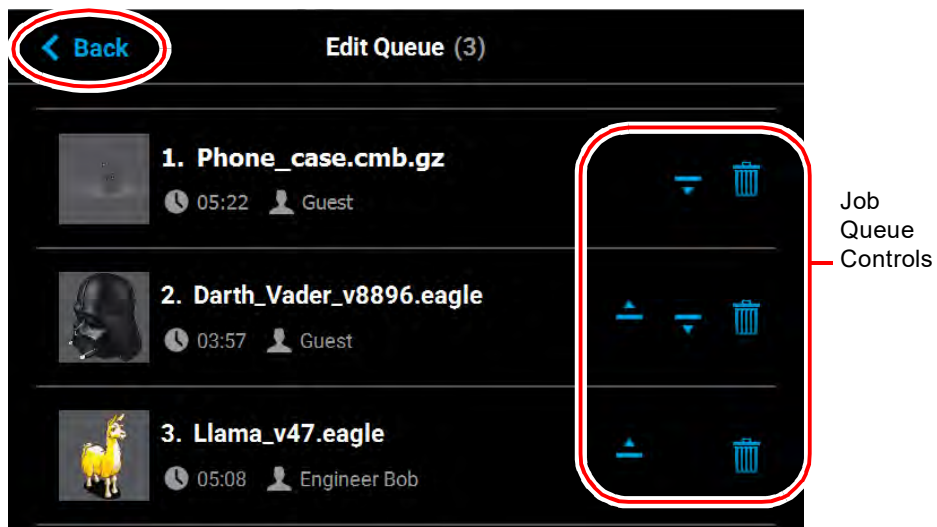

Figure 21: Edit Queue Page



## Job Queue Controls

After opening the Edit Queue page three Job Queue Control buttons will be displayed within each row of the Job Queue list (one set of buttons per entry in the list). These buttons will allow you to rearrange the jobs in the Job Queue as needed. These buttons have the following functionality:

Table 5: Job Queue Control Buttons

Name	Button States		Description
Move Up		Selectable	<ul style="list-style-type: none"> <li>When selectable, moves the selected job up one position in the job Queue list.</li> </ul>
		Disabled	<ul style="list-style-type: none"> <li>To move a job to the top of the Job Queue list, press this button repeatedly until the job appears at the top of the list.</li> <li>There is not an option to move a job directly to the top of the list.</li> </ul>
Move Down		Selectable	<ul style="list-style-type: none"> <li>When selectable, moves the selected job down one position in the Job Queue list.</li> </ul>
		Disabled	<ul style="list-style-type: none"> <li>To move a job to the bottom of the Job Queue list, press this button repeatedly until the file appears at the bottom of the list.</li> <li>There is not an option to move a job directly to the bottom of the list.</li> </ul>
Delete		Selectable	<ul style="list-style-type: none"> <li>Removes the selected job from the Job Queue list.</li> <li>You will not be asked to confirm this action prior to the job being deleted from the Job Queue.</li> </ul>

## Viewing Job Details

To view additional details regarding a particular job in the Job Queue, select the desired job by touching its row on the screen. Doing so will open its Job Details page; this page displays the following:

- Duration: amount of time required to complete the build.
- Author: name of the user that submitted the job.
- Materials: model and support materials associated with the job.
- Layers: number of layers in the job.
- Slice height: slice height associated with the job.

Use the scrollbar (along the right side of the page) to scroll up or down within the page. To close this page and return to the main Queue page, press the **Back** button within the header of the page.

Figure 22: View Job Details

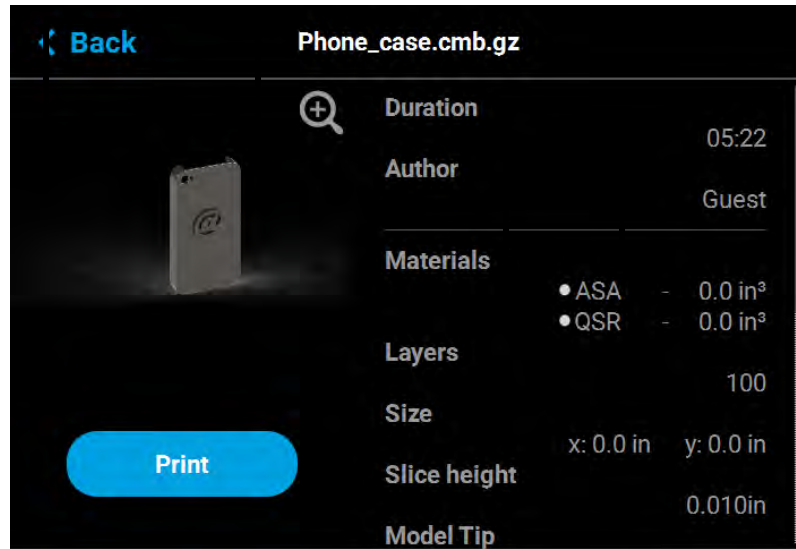

The left portion of the Job Details page displays a visual representation of what the part will look like once the build is complete.

Pressing the **Zoom In** button  within the upper-right corner of this portion of the page will hide the job details information and instead zoom in on the representation of the completed part (as shown in Figure 23).

Press the **Zoom Out** button in the upper-right corner of the expanded view display to close the expanded view and return to the Job Details page.

Figure 23: View Job Details - Expanded View



## About the Sample Queue

The printer comes with several sample job files permanently installed on its hard drive. These files are accessible via the Sample Queue. This queue is composed of a few sample part files as well as a variety of other files that are helpful for testing the printer. The majority of the files within the Sample Queue will be utilized only by authorized service representatives when performing maintenance on the printer. To access the Sample Queue:

10. Navigate to the Queue page by pressing the **Queue** button within the Navigation Menu.
11. Press the **Load File** button in the upper-right corner of the touchscreen (see [Figure 15 \(page 47\)](#) for button location).
12. The Load File page will be displayed; press the **Internal Storage** button within this page. The list of sample jobs contained within the Sample Queue will be displayed.

Figure 24: Load File Page - Internal Storage Option

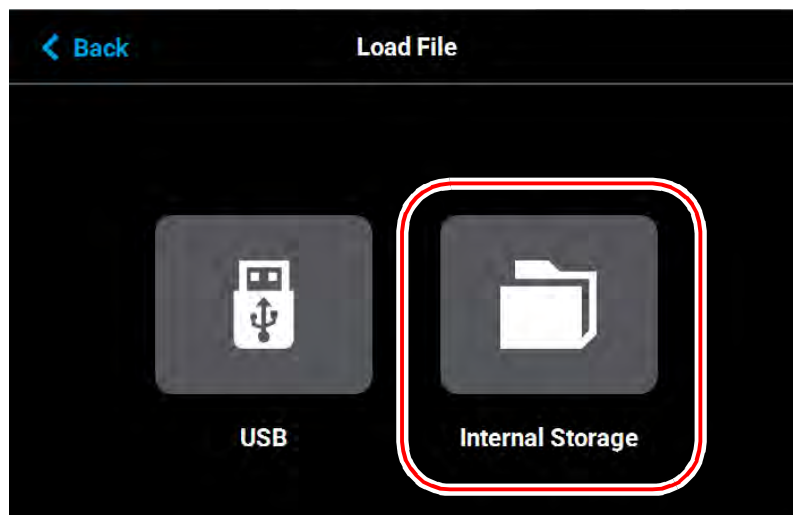

Overall, the functionality of the Sample Queue is the same as that of the Job Queue:

- Additional details for a job can be viewed by opening its Job Details page.
- Within the Job Details page you can view the specifics of the job including build time, author, material requirements, number of layers, and slice height.
- Pressing the Zoom In button within the page will provide a detailed view of what the job will look like once it has been successfully built. Pressing the Zoom Out button will close this view and return you to the Job Details page.
- Pressing the Print button within the Job Details page will select the job for building.

However, the following functionality differences exist for the Sample Queue:

- “[Job Queue Controls](#)” are disabled for the Sample Queue, and therefore these job files cannot be deleted.
- Jobs in the Sample Queue cannot be sorted (as described in “[Editing the Job Queue](#)” (page 49)).

# Working with the Materials Page

The Materials page displays a detailed representation of the printer's current materials configuration. Within this page you can view the printer's current materials configuration including material types and colors, view material coil box volumes and load statuses, load and unload materials, view current and set point head temperatures, and perform a variety of head related maintenance functions.

To access the Materials page, press the **Materials** button within the Navigation Menu; a screen similar to the one in Figure 25 will be displayed.

Figure 25: Materials Page

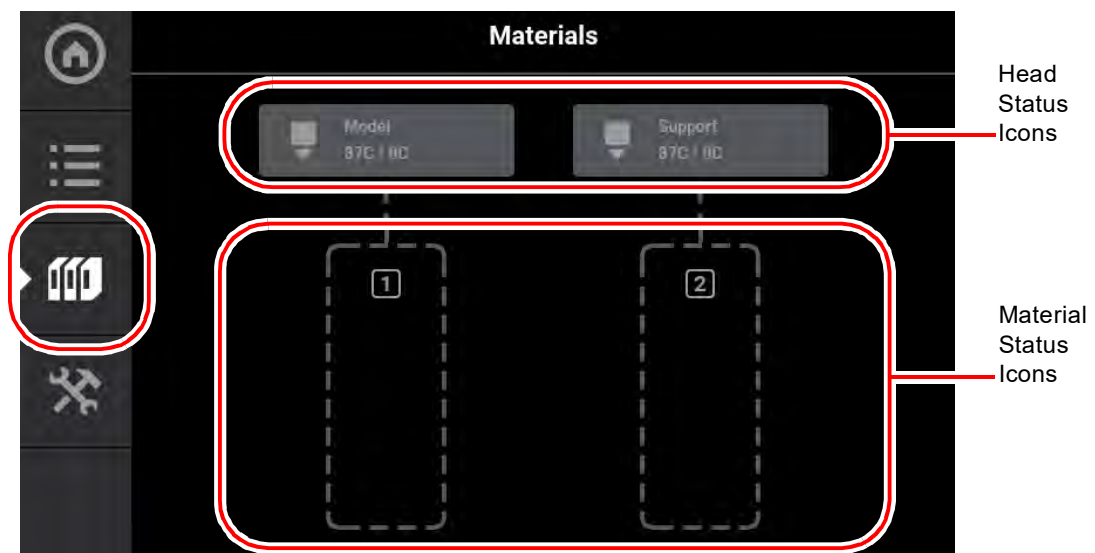

Two “Head Status Icons” are displayed within the upper portion of the Display Area. These icons display load status information as well as the current temperature as compared to the set point temperature of each of the printer's heads (temperatures are predetermined and based on material type loaded to the head). The right-most icon pertains to the printer's support head while the left-most icon pertains to the printer's model head. Touching one of these icons on the screen will open that head's Head Details page; this page contains additional information pertaining to the selected head as well as a button for initiating a variety of head maintenance functions. Icons will be solid gray or solid blue depending on their status.

Two “Material Status Icons” are displayed within the lower portion of the Display Area. These icons represent the model and support materials loaded/installed within the printer. The right-most icon indicate the status of the printer's support material while the left-most icon indicate the status of the printer's model material. These icons will take on a variety of colors and highlighted states depending on their status. Material coil boxes whose material is loaded to the head, are indicated by a blue border. Touching one of these icons on the screen will open that material's Material Details page; this page contains additional information pertaining to the selected material as well as buttons for performing a material load or unload.

After selecting any icons or opening a details page a “Back” button will be displayed within the heading of the page; press this button to return to the main Materials page.

## Head Status Icons

The two Head Status Icons within the Materials page display load status information as well as the current temperature as compared to the set point temperature of each of the printer's heads. The right-most icon pertains to the printer's support head while the left-most icon pertains to the printer's model head. Touching one of these icons on the screen, unless otherwise indicated in [Table 6](#), will open that head's Head Details page. Various graphics will be displayed within the left portion of the Head Status Icons, depending on the state of the head. The Head Status Icons can appear in the following states (color usage, highlighting, and descriptions apply to both icons):

Table 6: Head Status Icons - Icon States





Icon State	Description
 Empty (gray dashed border)	<ul style="list-style-type: none"> <li>Indicates that the associated head is not installed.</li> <li>User action required to install head. See <a href="#">“Head Replacement” (page 111)</a> for instructions.</li> <li>Touching the icon in this state will not display the head's Head Details page.</li> </ul>
 Invalid (red dashed border)	<ul style="list-style-type: none"> <li>Indicates that the associated head is invalid.</li> </ul> <p><b>Note:</b> This icon will also display when a model head is placed in a support location or a support head is placed in a model location. In these cases, the head is usable when placed in its proper location.</p> <ul style="list-style-type: none"> <li>User action required to replace head with a valid head. See <a href="#">“Head Replacement” (page 111)</a> for instructions.</li> <li>Touching the icon in this state will not display the head's Head Details page.</li> </ul>
 Initializing	<ul style="list-style-type: none"> <li>Indicates that the printer is initializing the head. This state will be displayed until the initialization process is complete following installation of a new head.</li> <li>Touching the icon in this state will not display the head's Head Details page.</li> </ul>
 Unloaded (solid gray)	<ul style="list-style-type: none"> <li>Indicates that material is not loaded to the head.</li> <li>User action required to load material. See <a href="#">“Loading Material” (page 100)</a> for instructions.</li> </ul>
 Loaded (solid blue)	<ul style="list-style-type: none"> <li>Indicates that material is loaded to the head.</li> <li>If a build has been initiated, the current temperature will increase until it reaches the set point temperature for the loaded material. Once temperature is reached, the tip will purge a small amount of material and the printer will begin building.</li> </ul>

Table 6: Head Status Icons - Icon States (Continued)



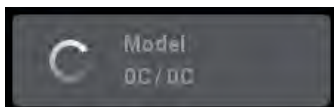
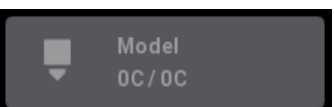

Icon State	Description
 <p>Active (solid blue with white border)</p>	<ul style="list-style-type: none"> <li>Indicates that the head is actively performing a task other than building.</li> <li>This state will be displayed whenever the head is purging or material is being unloaded from the head.</li> </ul>
 <p>Warning (head unloaded)</p>	<ul style="list-style-type: none"> <li>Yellow coloring and an associated notification badge indicates a head related warning (see “Head Warnings” (page 216)).</li> <li>Additional information regarding the warning and possible correction information is displayed by opening the associated head’s Head Details page (see “Viewing Head Details” (page 56)).</li> </ul>
 <p>Warning (head loaded)</p>	<ul style="list-style-type: none"> <li>When the head’s odometer reaches 1350 build hours a warning will be displayed reminding you to order a replacement head as the head is approaching its odometer limit.</li> </ul>

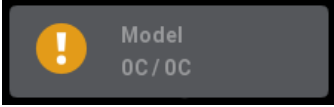

Table 6: Head Status Icons - Icon States (Continued)

Icon State	Description
 <p>Error (head unloaded)</p>	<ul style="list-style-type: none"> <li>Red coloring and an associated notification badge indicates a head related error (see “Head Errors” (page 216)).</li> <li>Additional information regarding the error and possible correction information is displayed by opening the associated head’s Head Details page (see “Viewing Head Details” (page 56)).</li> </ul>
 <p>Error (head loaded)</p>	<ul style="list-style-type: none"> <li>When the head’s odometer reaches 1500 build hours an error will be displayed. The printer is still able to build with this head, but you will be reminded before starting each build that the head’s odometer limit has been reached and part quality may be negatively affected. User action is required to replace head. See “Head Replacement” (page 111) for instructions.</li> <li>If the associated head is incompatible with the location where it is installed (i.e. if the model head is installed in the support head location), an error will be displayed. After clicking on the error icon, a message will display with instructions to replace whichever head (model or support) was incorrectly installed.</li> </ul> 

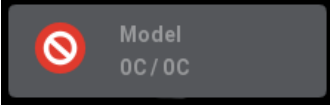
## Viewing Head Details

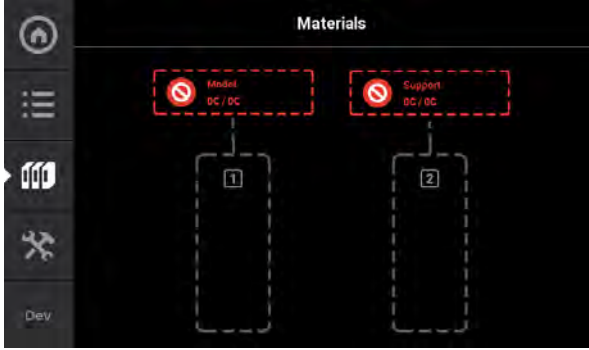
To view additional details regarding the printer’s model or support head, select the desired head by touching its Head Status Icon on the screen. Doing so will open its Head Details page. If the head is in a warning or error state additional information pertaining to the warning/error will be displayed within the page (see “Head Warnings” (page 216) and “Head Errors” (page 216) for details).

The right portion of the screen displays status information pertaining to the selected head:

- State: displays the load status of the corresponding head.
- Last Material: displays the type of material last loaded to the head.
- Date Loaded: displays the date that material was last loaded to the head.

- Odometer: displays the amount of build time for the selected head. This value is important as the printer will display different errors depending on the amount of build time for a head.
  - When a head's odometer reaches 1350 build hours the Head Status Icon will be displayed in its warning state, and you will be prompted to order a replacement head.
  - When a head's odometer reaches the 1500 build hours odometer limit, the Head Status Icon will be displayed in its error state, and you will be prompted to replace the head. You can continue to build using the head, but part quality will be unpredictable. It is recommended that you immediately change a head which has exceeded its odometer limit (see "Head Replacement" (page 111) for instructions).
- Serial Number: displays the head's unique serial number.
- Manufacturing Date: displays the date that the head was manufactured.

The left portion of the screen displays the same Head Status Icon as is displayed on the Materials page (see Figure 25 (page 53)). This icon displays the current temperature as compared to the set point temperature of the head. The Maintenance button directly below the Head Status Icon will display a menu allowing you to perform a variety of head maintenance functions.

To close this page and return to the main Materials page, press the **Back** button within the header of the page.

Figure 26: Head Details Page

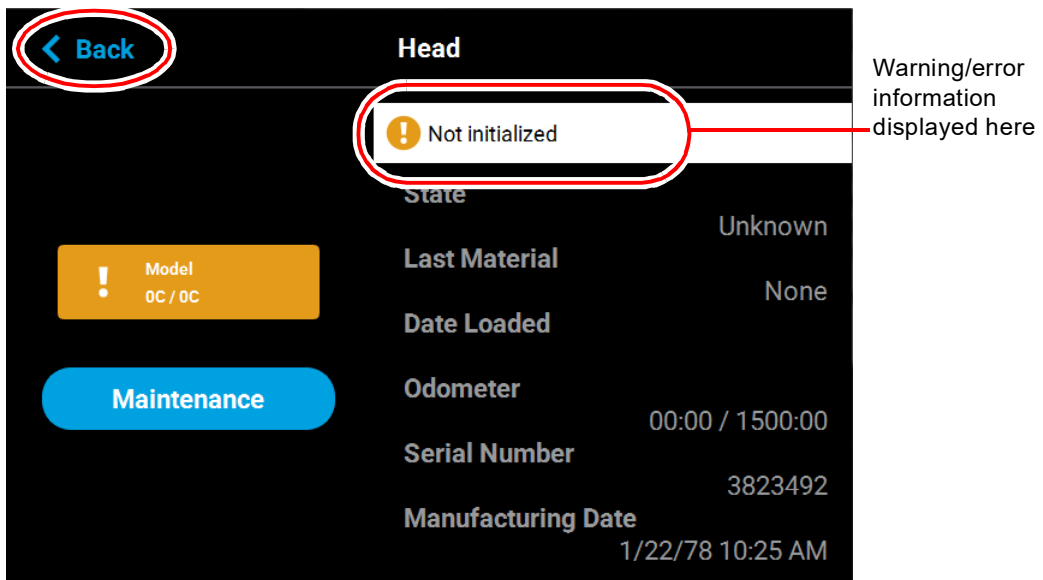

## Head Maintenance

Pressing the **Maintenance** button within the Head Details page will open the Head Maintenance page. The buttons within this page will allow you perform a variety of head maintenance functions. The buttons displayed in the menu within the right half of the screen will vary depending on whether the Enable button has been pressed. After pressing the Maintenance button the button will toggle and instead display the Details button. Pressing the **Details** button will close the Head Maintenance page and return you to the Head Details page.

### **Enable**

Pressing the Enable button puts the corresponding head into a maintenance state when the top cover has been opened. Before you can perform any of the head maintenance functions available within the Head Maintenance page, you must put the head into this state by pressing the **Enable** button. After pressing the Enable button, the menu will refresh and display buttons corresponding to the additional head maintenance functions available within this page. The Enable button will toggle and instead display the Disable button. Pressing the **Disable** button at any time when the head is not in use will take the head out of the maintenance state.

Figure 27: Head Maintenance Page - Main View

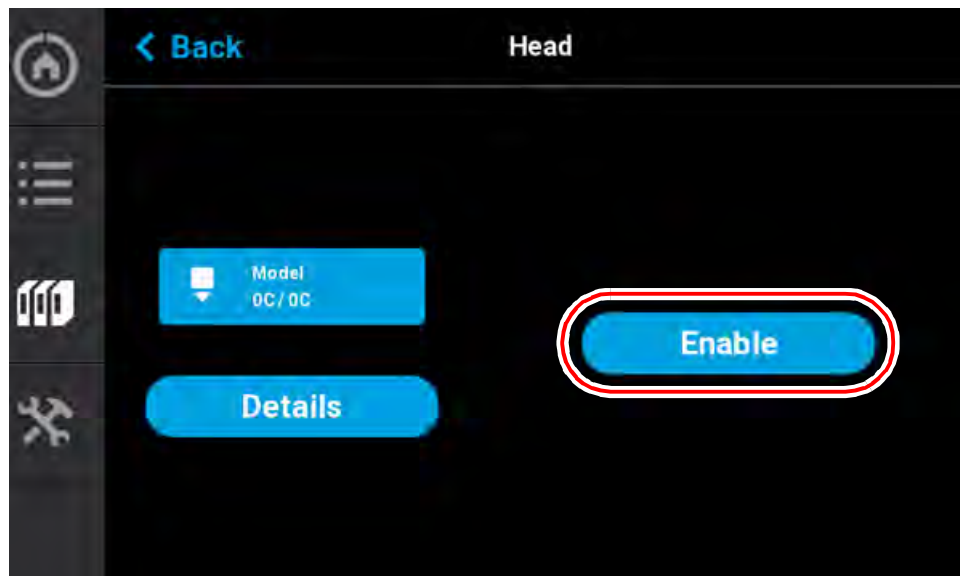

### **Purge**

Pressing the **Purge** button instructs the printer to perform a long purge. After pressing this button, the head will move to the purge position and will heat to a predetermined set point temperature. Once the head reaches this set point, material will be purged from the tip for about 10 seconds. When changing to or from colored material it is beneficial to perform multiple purges as this will remove all material remaining within the liquefier tips and/or tubes to ensure that color mixing doesn't occur. The Purge button is selectable (i.e. a Purge can be initiated) when the button is solid blue, and disabled (i.e. a Purge is in process or cannot be initiated) when gray. A notification badge will be displayed within the button if any preconditions exist preventing the purge from occurring.

### **Load Head/Unload Head**

Depending on the load status of the selected head, either the Load Head or Unload Head button will be displayed. Pressing the **Load Head** button instructs the printer to load material to the corresponding head; the button will toggle to display the Unload Head button. Pressing the **Unload Head** button instructs the printer to unload material from the corresponding head; the button will toggle to display the Load Head button. A notification badge will be displayed within the button if any preconditions exist preventing the load/unload from occurring (see "Load/Unload Errors" (page 209)).

### Heat/Cool

Depending on the state of the printer, either the Heat or Cool button will be displayed. Pressing the **Heat** button instructs the printer to heat the corresponding tip to 270°C for no longer than 2 minutes; the button will toggle to display the Cool button. Pressing the **Cool** button will instruct the printer to begin cooling the corresponding tip back to the 0 set point; the button will toggle to display the Heat button. The tip will also begin to cool automatically if the heat option exceeds the 2 minute time allotment and the Cool button is not pressed.

Figure 28: Head Maintenance Page - Menu View

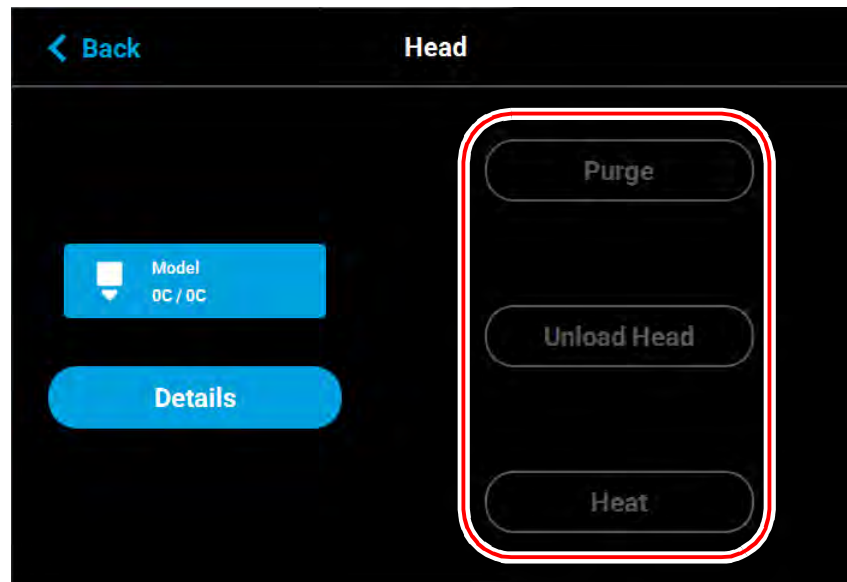

## Material Status Icons

The Material Status Icons within the Materials page represent the model and support material coil boxes loaded in the printer. Either two icons will be displayed. Each icon displays a number corresponding to the material coil box, colored bars indicating the color of the material currently installed, the name of the material currently installed, and a percentage indicating the current volume of material on that material coil box. Touching one of these icons on the screen, unless otherwise indicated in [Table 7](#), will open that material's Material Details page. Various graphics

will be displayed within the center of the Material Status Icons, depending on the state of the material coil box. The Material Status Icons can appear in the following states (color usage, highlighting, and descriptions apply to all icons):

Table 7: Material Status Icons - Icon States







Icon State	Description
 <p>Empty (gray dashed border)</p>	<ul style="list-style-type: none"> <li>Indicates the filament key is not inserted.</li> <li>User action required to load material and insert the filament key. See “Loading Material” (page 100) for instructions.</li> <li>Touching the icon in this state will display the Material Details page.</li> </ul>
 <p>Unusable (semi-solid red)</p>	<ul style="list-style-type: none"> <li>Indicates that an error occurred when checking the data on the material coil box’s memory chip. The material coil box is unusable.</li> <li>User action required to replace the current material coil box with a valid one. See “Handling/Storing Materials” (page 111) and “Connecting Material Coil Box To Printer” (page 101) for instructions.</li> <li>Touching the icon in this state will not display the material’s Material Details page.</li> </ul>
 <p>Invalid (red border)</p>	<ul style="list-style-type: none"> <li>Indicates that the material coil box is invalid. Invalid materials are materials not licensed or not compatible with the associated head type.</li> <li>Material from the invalid material coil box cannot be loaded. User action required to replace the current material coil box with a valid one. See “Handling/Storing Materials” (page 111) and “Connecting Material Coil Box To Printer” (page 101) for instructions.</li> </ul>

Table 7: Material Status Icons - Icon States (Continued)

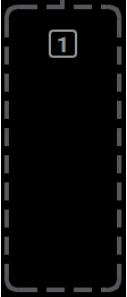
Icon State	Description
 <p>Loaded (blue border)</p>	<ul style="list-style-type: none"> <li>Valid material coil box connected. Material name, color, and current volume displayed.</li> <li>Material from the material coil box is loaded to the head and is selected to be used for building.</li> <li>See “<a href="#">Selecting a Job to Build</a>” (page 115) for instructions on starting a build. See “<a href="#">Unloading Material</a>” (page 108) for instructions on unloading material.</li> </ul>
 <p>Empty Material Coil Box (solid yellow)</p>	<ul style="list-style-type: none"> <li>Material coil box is empty - a volume of 0% is displayed.</li> <li>User action required to replace the empty material coil box. See “<a href="#">Unloading Material</a>” (page 108) for instructions.</li> </ul>
 <p>Error (solid red)</p>	<ul style="list-style-type: none"> <li>Indicates that communication with the material coil box is not possible. Please note that this state differs from the unusable state as the icon is solid red in this state and the bars within the center of the icon are not visible.</li> <li>Contact Customer Support or your regional Stratasys office if you experience this icon state (see “<a href="#">Getting Help</a>” (page 205) for contact information).</li> </ul>

## Viewing Material Details

To view additional details regarding a particular material, select the desired material by touching its Material Status Icon on the screen. Doing so will open its Material Details page. If the material coil box is in a warning or error state additional information pertaining to the warning/error will be displayed within the page (see “[Load/Unload Errors](#)” (page 209) for details).

The right portion of the screen displays detailed information about the material coil box including:

- State: load state.

- Type: the type of material in the material coil box. If applicable, material color is also indicated (material color is also indicated within the center of the Material Status Icon within the left portion of the screen).
- Current Volume: current volume of material in the material coil box in cubic inches. This is also indicated via the percentage displayed within the Material Status Icon within the left portion of the screen.
- Total volume: total volume of material available, in cubic inches, when the material coil box was initially installed.

The buttons directly below this information allow you to load or unload material as needed or cancel a load/unload in process (see “Material Load Controls” (page 63) for details). Please note that the functionality and visibility of these buttons will depend on the material load status.

The left portion of the screen displays the same Materials Status Icon as is displayed on the Materials page (see Figure 25 (page 53)). The number displayed within the top of the icon indicates which material port the material is loaded into. The colored bars (displayed within the center of the icon) and percentage (displayed at the bottom the icon) indicate the current volume and color of the material in the material coil box. As material is used to build a part, the number of colored bars and the percentage will decrease to indicate the amount of material consumed. The name of the type of material in the box is displayed at the bottom of the icon.

To close this page and return to the main Materials page, press the **Back** button within the header of the page.

Figure 29: View Material Details

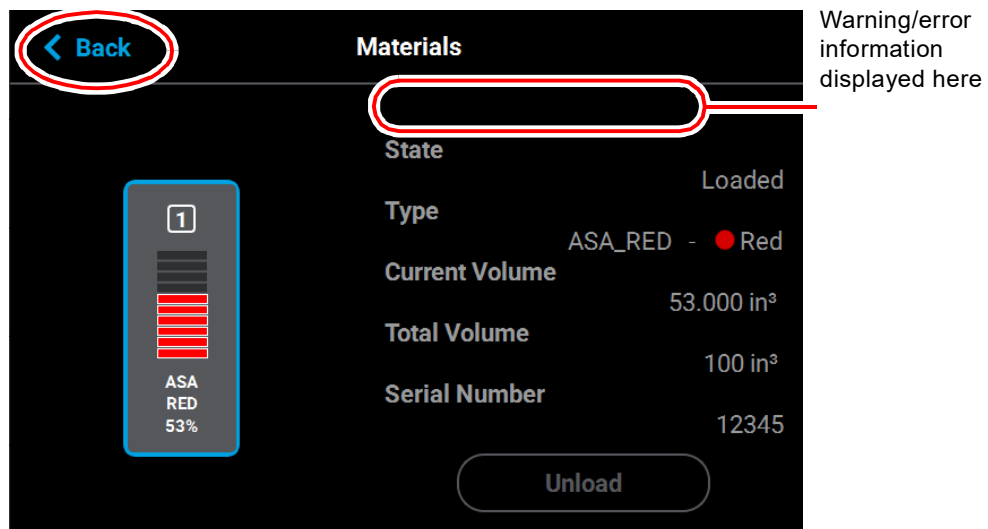

## Material Load Controls

The Material Load Control buttons are used to load and unload material to the liquefier within the head, as well as cancel a material load or unload in process. The Material Load Control buttons are displayed in the lower-right portion of the Material Details page; however, the visibility of these buttons is dependent upon the material coil box's load status. Button states are explained within the tables below.

Figure 30: Material Load Control Buttons

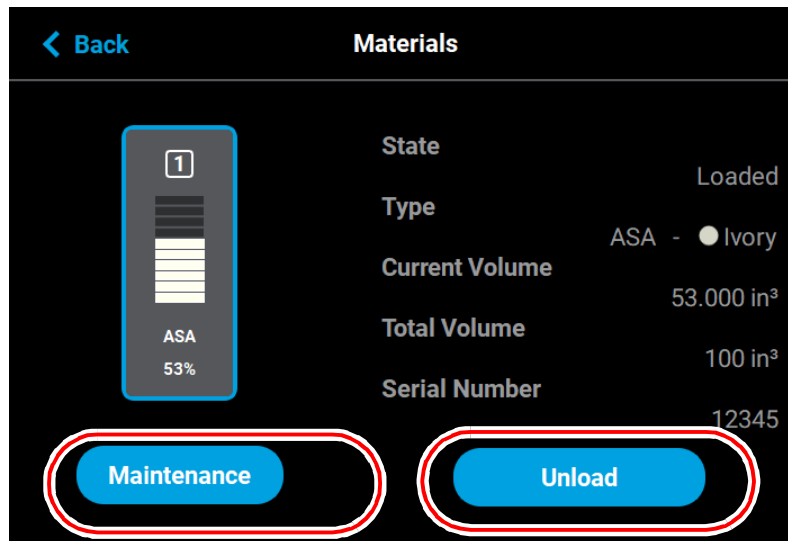

Pressing the Load button initializes the load wizard. The load wizard instructs the user on the steps necessary to load material into the F120 (see “Loading Material” (page 100) for details). If the corresponding head is already loaded with material, the Load button will appear in its disabled state.

Pressing the Unload initializes the unload wizard. The unload wizard instructs the user on the steps necessary to unload material from the F120 (see “Unloading Material” (page 108) for details).

The Cancel button will be displayed for a spool only after the spool's corresponding Unload or Load button has been pressed. Pressing this button will instruct the printer to cancel the material load or unload already in process (see “Material Load/Unload Cancellation” (page 68) for details).



Pressing the Maintenance button displays the Material Maintenance screen.

Figure 31: Materials Maintenance Screen

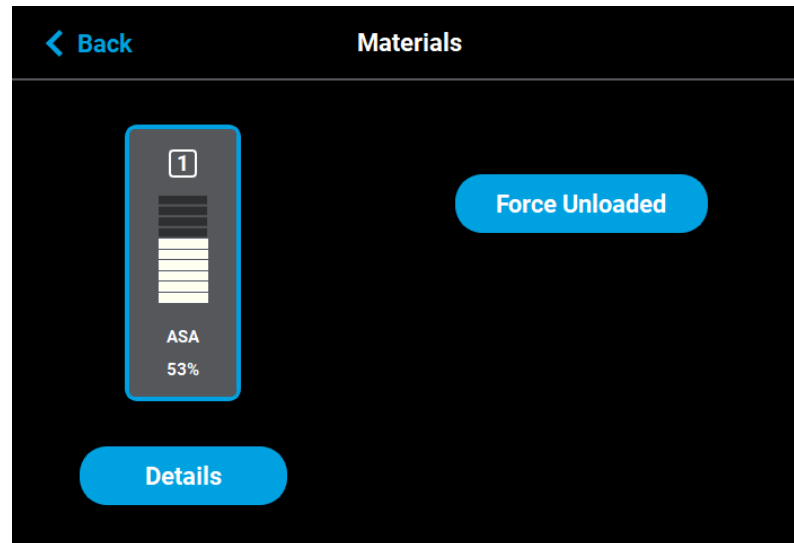

Pressing the Force Unloaded button sets the head and material bay to Unloaded status. This is used in situations where the system incorrectly displays a Loaded status for a print head. It is possible to use this button to set the head status to Unloaded when the head is actually loaded. If this occurs, perform a standard load procedure and the status will be corrected.

Pressing the Details button displays the Materials screen.

Table 8: Material Load Control Buttons - Load Button States



Button State	Description
	<ul style="list-style-type: none"> <li>The load button is accessed from the Materials page.</li> <li>Pressing the Load button in this state will initialize the load wizard for the corresponding head.</li> </ul>
	Load button is disabled and not selectable.

Table 9: Material Load Control Buttons - Unload Button States

Button State	Description
	<ul style="list-style-type: none"> <li>The Unload button is only selectable once a material filament is loaded to the corresponding head.</li> <li>Pressing the Unload button in this state will initialize the unload wizard for the corresponding head.</li> </ul>
	Unload button is disabled and not selectable.

Table 10: Material Load Control Buttons - Cancel Button States



Button State	Description
	<ul style="list-style-type: none"> <li>The Cancel button is never selectable.</li> </ul>

## Load Wizard States

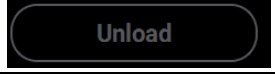
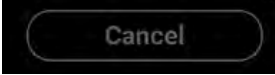
The pathway between the Material Status Icon and corresponding Head Status Icon will take on a variety of colors and display various graphics, depending on the load state of the associated material coil box's filament. The pathway of the empty filament port will be dashed gray. Only one material type can be loaded/unloaded at a time (i.e. a model and support

material coil box cannot be loaded/unloaded simultaneously). Filament pathways can appear in the following states (color usage, highlighting, and descriptions apply to both model and support):

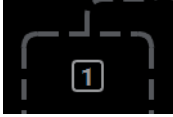
Table 11: Filament Pathway States

Icon State	Description
 Empty	<ul style="list-style-type: none"> <li>Indicates that a material is not loaded into the corresponding filament port.</li> <li>After connecting a material coil box to the printer, the filament pathway will refresh and indicate that filament needs to be inserted into the drive mechanism.</li> </ul>
 Loading/ Unloading	<ul style="list-style-type: none"> <li>Indicates that filament from the corresponding material coil box is in the process of being loaded to the head.</li> <li>The pathway between the Material Status Icon and the Head Status Icon will fill, in blue, in the direction that the material coil box's filament is traveling (towards the head).</li> <li>Once the load process is complete, the filament pathway will refresh and display in its loaded state.</li> </ul>
 Loaded	<p>Indicates that filament from the corresponding material coil box is loaded to the head and is selected to be used for building.</p>

As materials are loaded and unloaded, the pathway between the Material Status Icon and the Head Status Icon will become colored, and will fill in the direction that the material coil box's filament is traveling (towards the head or away from the head). [Figure 32 \(page 67\)](#) depicts the functionality displayed when a material coil box's filament is being loaded to the head, while [Figure 33 \(page 68\)](#) depicts the functionality displayed when a material coil box's filament is being unloaded from the head. Opening the Material Details page for the material being loaded/unloaded will provide additional control over the load/unload. The Cancel button will be displayed within this page, giving you the option to cancel the material load/unload if necessary.

Material load progress will display the same functionality regardless of whether a model or support material coil box is being loaded. Once a box's material is loaded to the head, the pathway between the Material Status Icon and the corresponding Head Status Icon will be solid blue, the Head Status Icon will turn solid blue, and the Material Status Icon will display a blue

border. This indicates that the material coil box is connected and in position to be used to build parts on the printer. The Unload button will be displayed within the Material Details page, indicating that material can be unloaded, if needed.

Figure 32: Material Load Progress - Loading

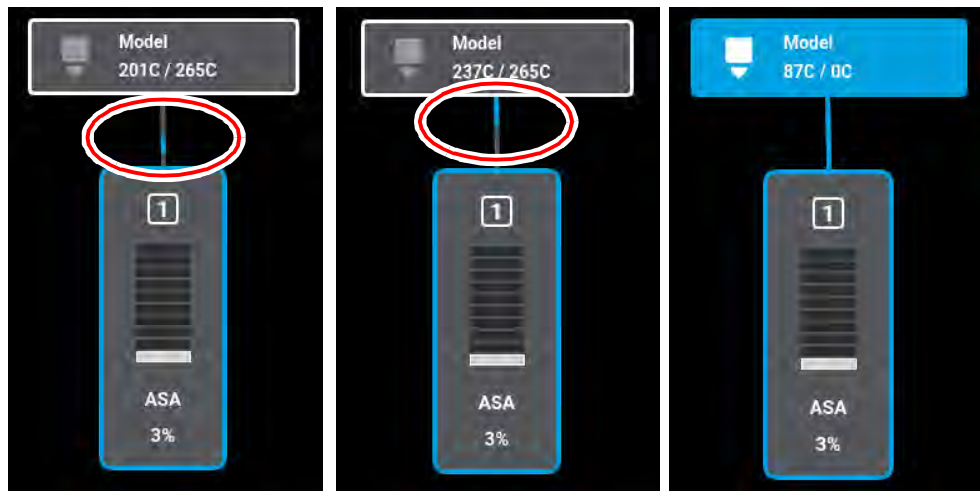

Material unload progress will display the same functionality regardless of whether a model or support material is being unloaded. As material is being unloaded from the head, the pathway between the Head Status Icon and Material Status Icon will be highlighted in yellow and the Head Status Icon will turn solid gray indicating that material is no longer loaded to the head. A yellow notification badge will be displayed within the center of the Material Status Icon to indicate that user action is required to complete the unload process.

Opening the Material Details page for the material being unloaded will provide additional details regarding the unload process. The Load button will be displayed within the Material Details page once the filament has been completely retracted indicating that the material can be reloaded, if needed.

Once material is fully unloaded, filament pathway and Material Status Icon coloring will remain in their unloading states until the corresponding material key is removed from its slot. Once the key is removed, which disconnects the material coil box, the filament pathway and Material Status Icon will refresh and display in their empty states.

Figure 33: Material Load Progress - Unloading

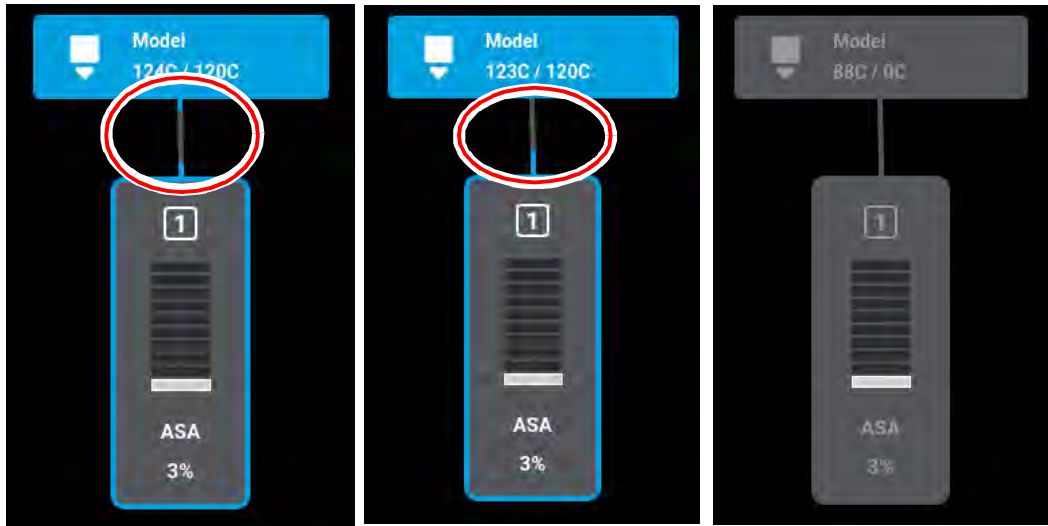

### Material Load/Unload Cancellation

The Cancel button will only be displayed within the Material Details page for a material that is in the process of being loaded/unloaded. This button allows you to cancel a material load or unload already in process. Depending on your printer's configuration, a warning may be generated after selecting the Cancel button. In the event of a warning, text will be displayed on the screen to indicate the cause of the warning.

Figure 34: Cancel Button

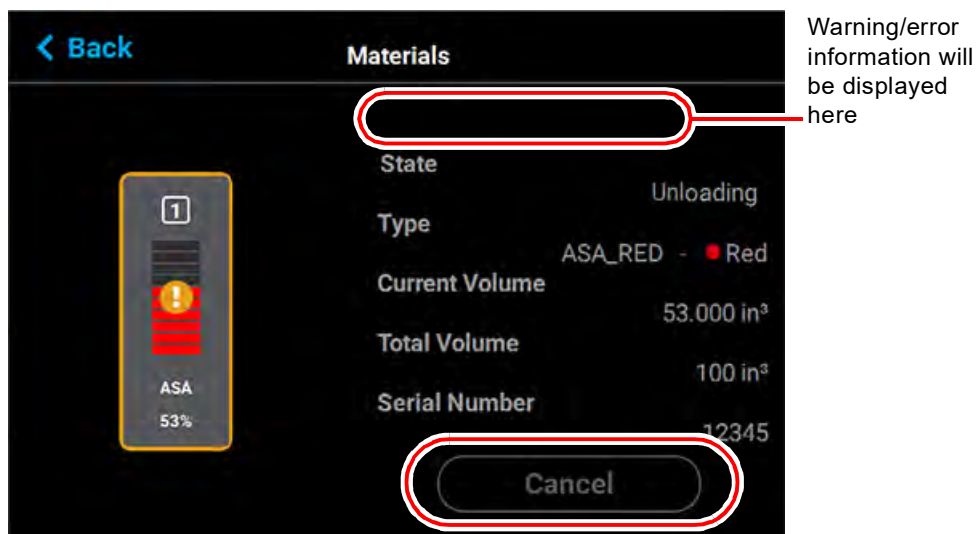

## Working with the Tools Page

The options within the Tools page are organized into 6 categories: Settings, Calibration, Maintenance, Network, Power, and Light. The Display Area of the Tools page contains a button corresponding to each of these categories. With the exception of the Light button, pressing the button corresponding to each of these categories will open an individual page containing printer information that can be viewed as well as printer settings and preferences which can be configured for that particular category. After selecting any of the buttons within the Tools page a “Back” button will be displayed within the heading of the page; press this button to return to the main Tools page.

Within this page you can turn a variety of printer settings on/off (including part placement, standby mode, etc.), select your printer’s address type (dynamic, static, or Wi-Fi), adjust the brightness of the touchscreen display and turn the printer or the oven light on/off. As a part of its initial installation and setup (performed by your authorized service representative) your printer’s network settings will be configured within this page (as described within “[Configuring the Network](#)” (page 10)). Once those settings are configured you may need to occasionally access this page in order to adjust printer preferences.

To access the Tools page, press the **Tools** button within the Navigation Menu; a screen similar to the one in [Figure 35](#) will be displayed.



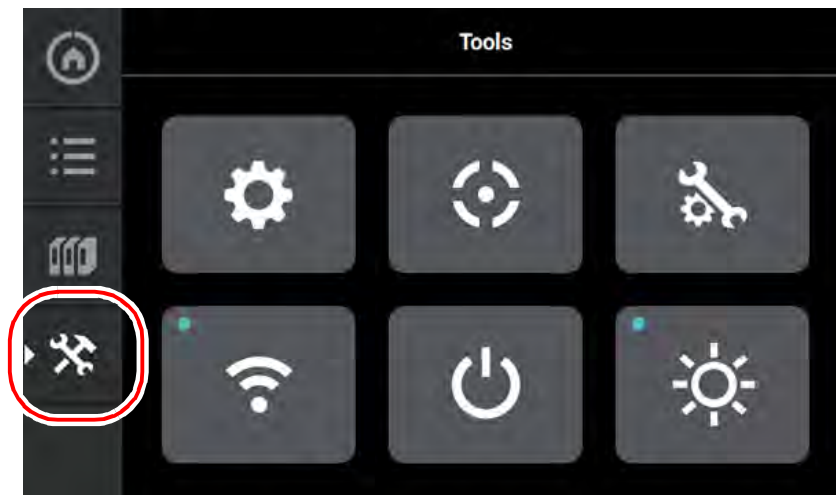



Figure 35: Tools Page



## Tools Page Menu

The Display Area of the Tools page contains 6 buttons. With the exception of the Light button, pressing each of these buttons will open an individual page containing printer information that can be viewed as well as printer settings and preferences which can be configured.

Table 12: Filament Pathway States

Icon State	Description
 Settings	Pressing the Settings button opens the Settings page. From this page you can configure and adjust several of the printer's default settings. See "Settings" (page 72) for details.
 Calibration	Pressing the Calibration button opens the Calibration page. From this page you can perform various printer calibration procedures. See "Calibration" (page 83) for details.
 Maintenance	Pressing the Maintenance button opens the Maintenance page. From this page you can perform various printer maintenance procedures. See "Maintenance" (page 86) for details.
 Network	Pressing the Network button opens the Network page. From this page you can configure the printer's network connection. See "Network" (page 90) for details.
 Power	Pressing the Power button opens the Power page. From this page you can shutdown or restart the printer. See "Power" (page 96) for details.
 Light	The Light button is the only option within the Tools page that does not open a new page after being pressed. Instead, the Light button allows you to turn the oven light ON and OFF. An indicator within the upper-left corner of the button displays the current state of the oven light (ON or OFF). See "Light" (page 97) for details.

## Navigation Overview

After selecting one of the buttons within the Tools page the touchscreen will refresh to display the details of the page selected (i.e. selecting the Settings button will open the Settings page). Depending on the options available for configuration within the selected page, the Display Area of the page may contain more options than can be displayed at one time. In this case, a scrollbar is displayed along the right-hand side of the page. To scroll up or down within a page simply touch the scrollbar displayed on the screen and pull the scrollbar in the direction you'd like to scroll.

A heading is displayed at the top of each page, indicating the name of the page. Each page contains a variety of settings and preferences that can be configured. Items are organized into individual rows within the Display Area of the page. The name of the setting/preference to be configured is displayed in bold within the left side of the row. For some items, current configuration information is displayed directly below the setting/preference name within the row (for reference purposes).

The graphic displayed within the right side of a row will vary depending on the configuration options available for that row. Rows containing a right arrow graphic will open a new page allowing you to configure that row's settings/preferences. Rows which do not contain a right arrow graphic do not have any configurable options. After making the necessary adjustments to a row's settings/preferences, press the **Back** button in the upper-left corner of the page to exit the page.

Figure 36: Settings Page Content List

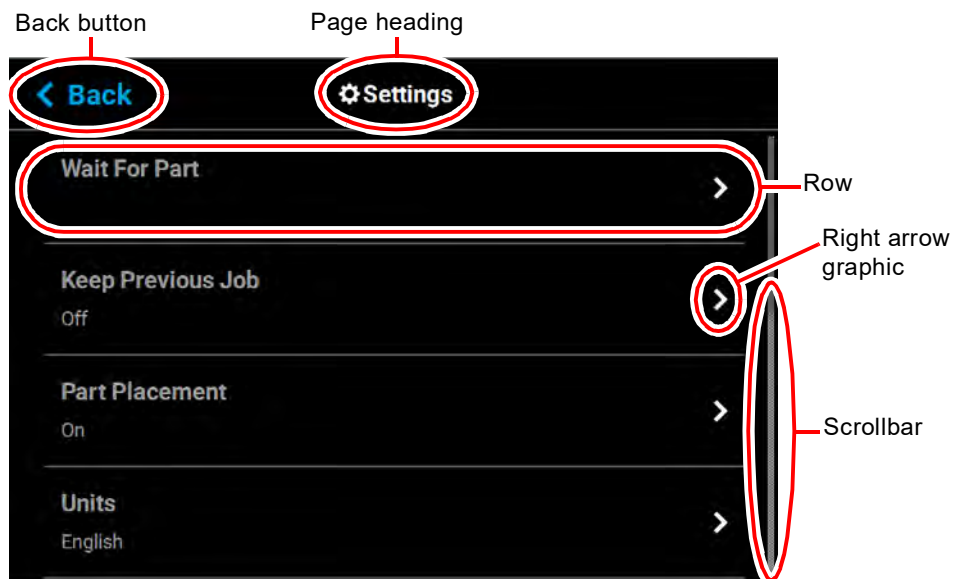



## Settings

The Settings page allows you to turn a variety of printer settings on/off (including part placement, standby mode, etc.), configure the language and units the printer/UI is configured for, and adjust the brightness of the touchscreen display.

To access the Settings page, press the **Settings** button within the Tools page; a screen similar to the following will be displayed. Use the scrollbar (along the right side of the page) to scroll up or down through the list of available options.

Figure 37: Settings Page

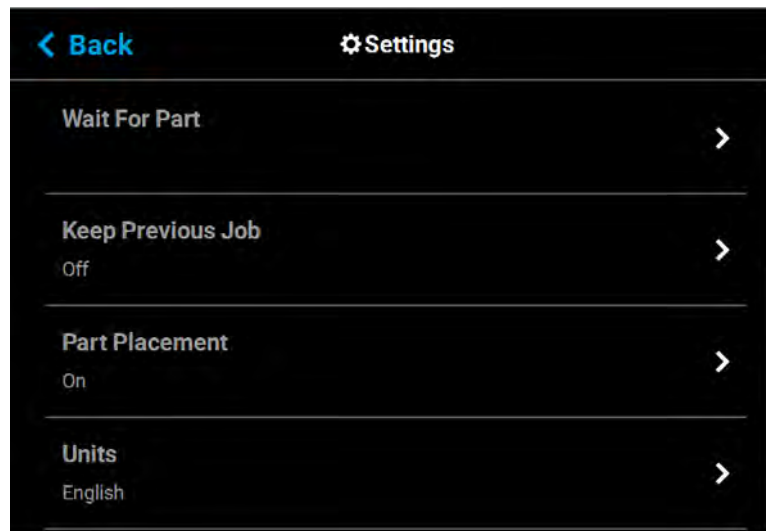

### Wait for Part

After sending a job file to the printer you would typically need to navigate within the User Interface in order to select the job from the Queue and start the build. The wait for part setting will instead allow you to send a job file to the printer which will then immediately start building once received by the printer.

Figure 38: Wait for Part

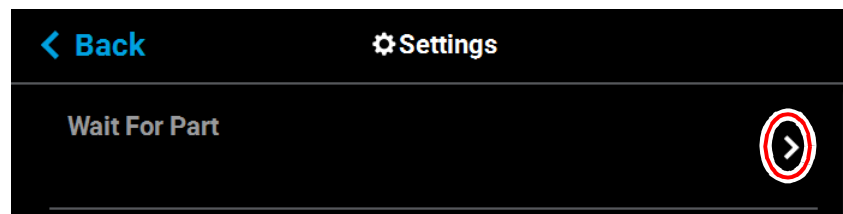

Pressing anywhere within the row will open the Wait For Part page. Opening this page will automatically put the printer into a state where it will wait to receive a job file to build immediately. After putting the printer into this state, you must send the processed job file to the

printer via GrabCAD Print. Once the job file is received by the printer, the job will automatically start building. As such, ensure that the printer has been properly prepared for the start of a build (see “Before a Build” (page 113) and “Preparing the Printer” (page 114) for details).

Figure 39: Waiting for Part

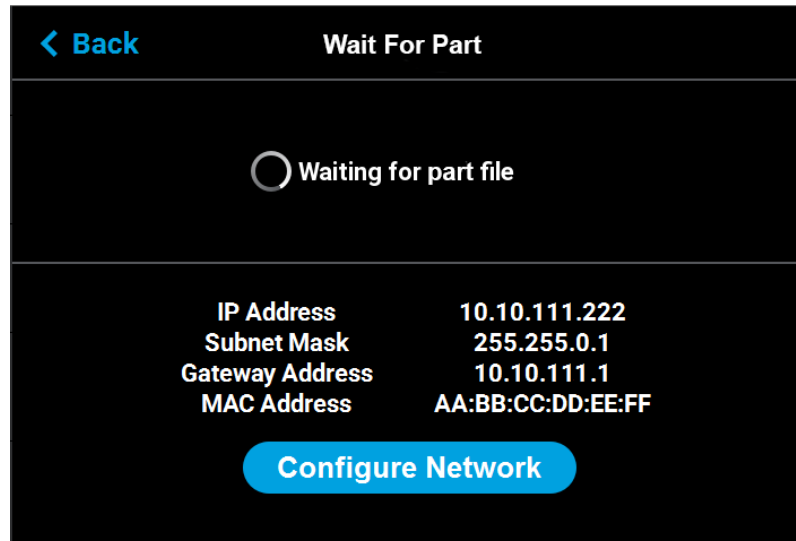

## Keep Previous Job

For privacy reasons, you have the option of choosing whether or not the printer’s previous job is stored within the Job Queue. If you’re concerned about other users of your printer seeing what you’ve built, this setting allows you to prevent other users from accessing the printer’s previous job. When this setting is set to On, the printer will store its previous job file making it available for re-selection within the Job Queue. When this setting is set to Off, the printer’s previous job file will be deleted from the Job Queue upon completion of the build. The job’s file will need to be resent to the printer in order to be built again.

Figure 40: Keep Previous Job

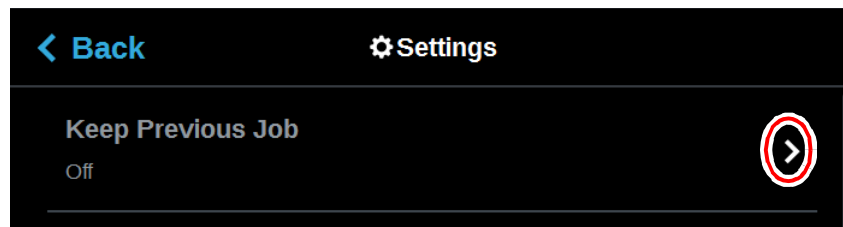

To configure this setting, press anywhere within the row; the Keep Previous Job page will be displayed. Use the radio buttons within the page to turn the setting On and Off as needed; On is selected by default.

Figure 41: Configure Keep Previous Job



## Part Placement

The Part Placement setting gives you the ability to select a job's placement on a substrate. By default, single part jobs are built in the center of a substrate while packs are built according to their selected placement within GrabCAD Print. Therefore, when this setting is set to Off, single part jobs will automatically be built in the center of the substrate and packs will be built according to their selected placement within GrabCAD Print. To configure this setting, press anywhere within the row; the Part Placement page will be displayed. Use the radio buttons within the page to turn the setting On and Off as needed.

Figure 42: Part Placement

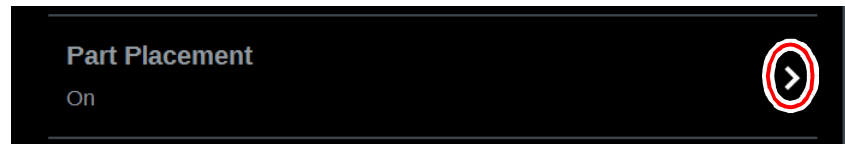

When this setting is set to On, you will be able to select a job's location on the substrate prior to starting the build (see "Selecting a Job to Build" (page 115)). At the start of a build a dialog will be displayed asking you to select the part's build location (see Figure 43). The dialog will contain a graphic representing your printer's platen as well as a blue bounding box graphic (the imaginary box surrounding the part).

You can select the part's build location by dragging and dropping the bounding box on the touchscreen; the bounding box cannot be placed outside the limits of the platen. Pressing the **Print** button will confirm your selected placement and start a build. "Ghost box" graphics are also displayed; a "ghost box" represents the location where a part was built previously. Clicking the **Clear History** button will clear the display, removing all "ghost box" items.

Figure 43: Part Placement Dialog

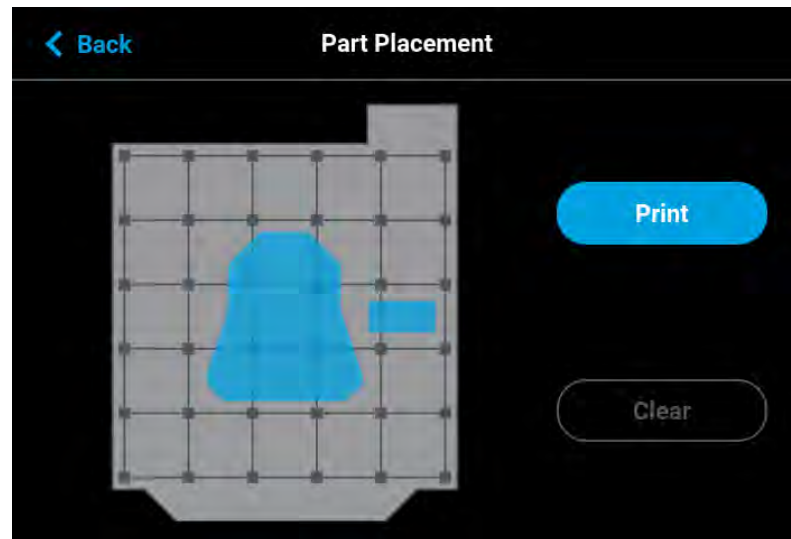

## First Layer Material

The First Layer Material row displays the material type to be used for the first build layer, Model or Default.

Figure 44: First Layer Material



To configure this setting, press anywhere within the row; the First Layer Material page will be displayed. Use the radio buttons within this page to select between Model and the Default material, which could be either model or support material. If ABS or ASA material and .005" slice height are selected, model material is automatically used for the first layer of material.

Figure 45: Configure First Layer Material

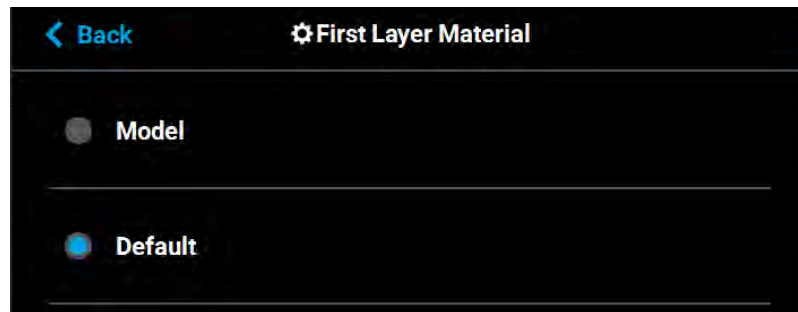

## Units

The Units row displays the type of units the printer is configured for, English (inches) or Metric.

Figure 46: Units

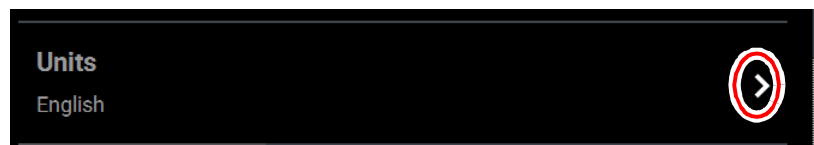

To configure this setting, press anywhere within the row; the Units page will be displayed. Use the radio buttons within this page to select between English and Metric units; English is selected by default.

Figure 47: Configure Units

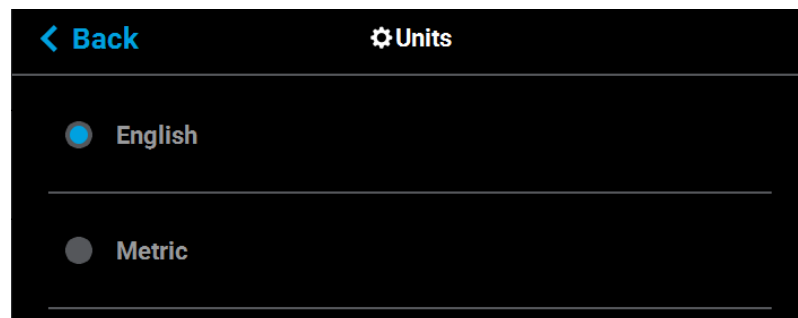

## Standby Mode

The Standby Mode setting gives you the ability to put the printer into an energy saving state after the completion of a build. When the Energy Saver radio button is selected (i.e. Standby Mode is turned On) the printer's oven will automatically shut off 2 hours after the completion of

a build, thus saving energy. When the Quick Start radio button is selected (i.e. Standby Mode is turned Off) the printer's oven will remain On for 60 hours after the completion of a build and oven temperature will stay at the material's build temperature.

Figure 48: Standby Mode

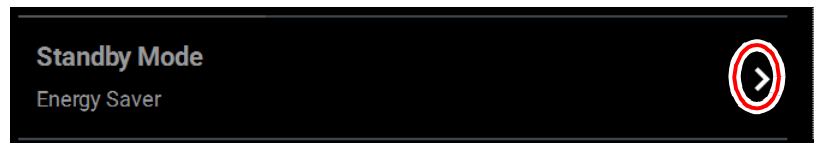

To configure this setting, press anywhere within the row; the Standby Mode page will be displayed. Use the radio buttons within the page to select between the Energy Saver and Quick Start options as needed. The Quick Start radio button is selected by default (i.e. Standby Mode is set to Off by default).

Figure 49: Configure Standby Mode

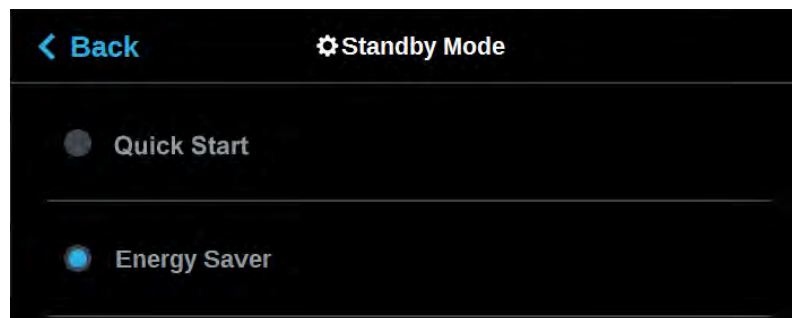

## Language

The Language row displays the language that the User Interface is configured for. Language options include English (default), Spanish, French, German, Italian, Korean, Russian, Chinese (traditional or simplified), and Japanese.

Figure 50: Language

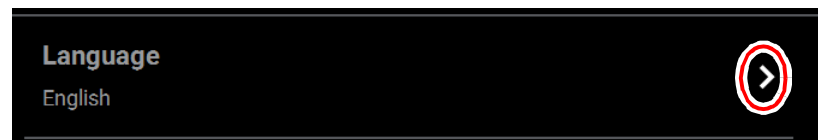

To configure this setting, press anywhere within the row; the Language page will be displayed. Use the scrollbar (along the right side of the page) to view the list of available languages. Select the radio button corresponding to your desired language.

Additionally, the first time the printer is powered ON, a dialog will be displayed asking you to select your desired language. Once you've set your desired language following initial power up, this selection will be retained and can only be changed by navigating to the Language page and adjusting your language selection.

Figure 51: Configure Language

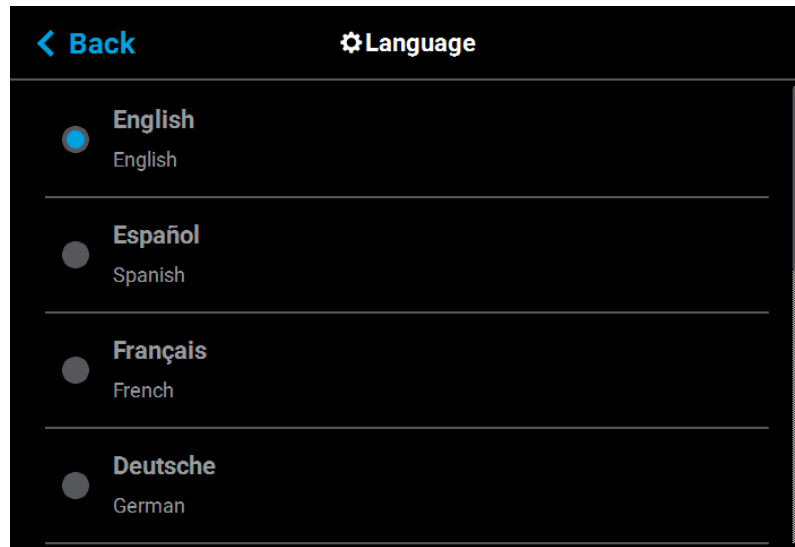

### Screen Brightness

The Screen Brightness setting allows you to adjust the brightness of the touchscreen display. This setting is displayed as a percentage with 100% percent representing the greatest amount of brightness available.

Figure 52: Screen Brightness



To configure this setting, press anywhere within the row; the Screen Brightness page will be displayed. Within this page use the slider graphic to adjust brightness as needed. Sliding to the right will increase brightness while sliding to the left will dim brightness. Please note that you cannot set screen brightness to 0% (completely dim).

Figure 53: Configure Screen Brightness

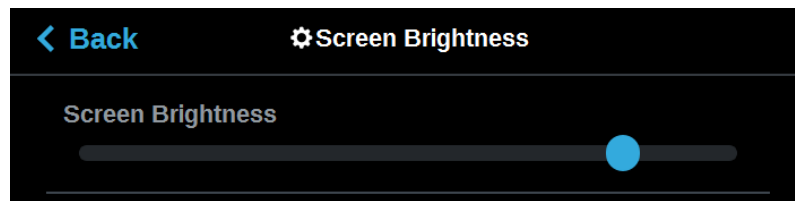

## UPnP

UPnP allows the printer to broadcast its Unique Device Name (UDN) address across the network. When this setting is set to On, the printer will broadcast its UDN across the network allowing GrabCAD Print to automatically detect the IP address of the printer for communication. When this setting is set to Off, the printer will not broadcast its IP address across the network and GrabCAD Print will need to be manually configured to communicate with the printer.

Figure 54: UPnP



To configure this setting, press anywhere within the row; the UPnP page will be displayed. Use the radio buttons within the page to turn the setting On and Off as needed; On is selected by default.

Figure 55: Configure UPnP



## Wifi

The Wifi setting gives you control over the printer's Wi-Fi capabilities. Please note that the functionality of this setting is dependent upon the use of a Wi-Fi dongle purchased for use with the printer. When this setting is set to On, you will be able to configure the printer to scan for and connect to an available Wi-Fi network. You will then be able to send part files to the printer via this network. When set to Off, Wi-Fi capabilities will be disabled and you will instead need to send part files to the printer via your facility's Ethernet connection or through the use of a USB flash drive (see "Configuring the Network" (page 10) for details).

Figure 56: Wifi





To configure this setting, press anywhere within the row; the Wifi page will be displayed. Use the radio buttons within the page to turn the setting On and Off as needed; On is selected by default.

Figure 57: Configure Wifi

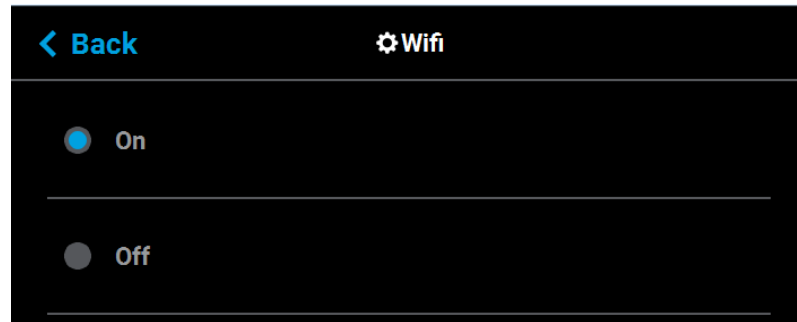

## Camera

The Camera setting gives you control over the printer's camera. When this setting is set to On, the printer's camera will automatically provide remote monitoring capabilities while a part is being built. When this setting is set to Off, the camera will be turned off and remote monitoring capabilities will be disabled.

Figure 58: Camera

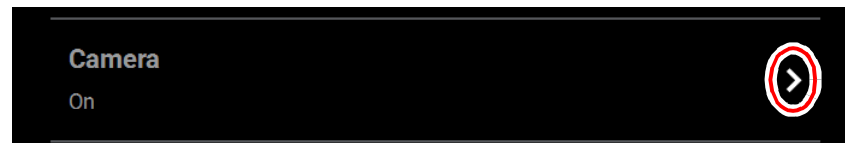

To configure this setting, press anywhere within the row; the Camera page will be displayed. Use the radio buttons within the page to turn the setting On and Off as needed; On is selected by default.

Figure 59: Configure Camera

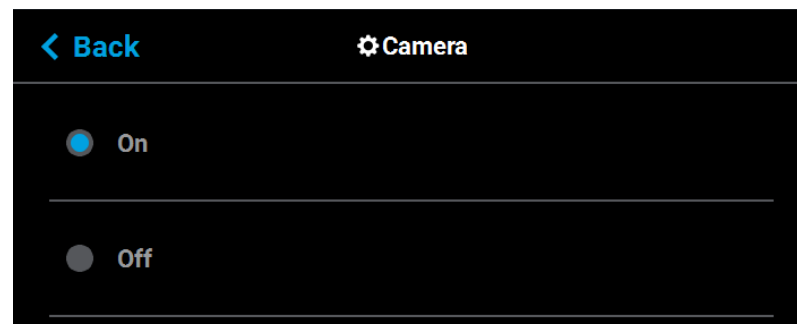

### Diagnostics Interface

This feature is for future use and is presently not supported. Stratasys will provide more information and training for its use and capabilities in the near future.

Figure 60: Diagnostics Interface



### Remote Access Permissions

The Remote Access Permissions settings allow the user to pause the current build or set the printer to standby mode. This feature is used in conjunction with the GrabCAD Print mobile application and a cellular phone.

Figure 61: Remote Access Permissions

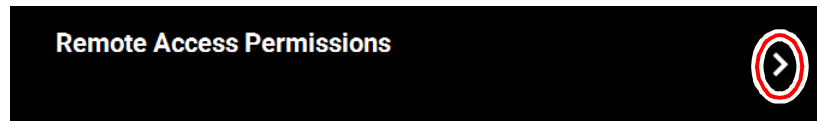

To configure this setting, press anywhere within the row; the Remote Access Permissions dialog displays.

Figure 62: Remote Access Permissions Dialog

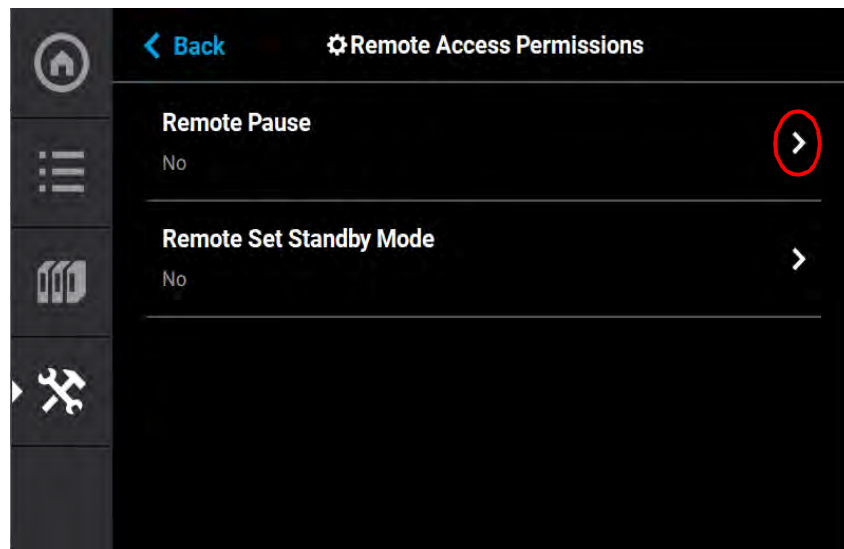

Both the Remote Pause and the Remote Set Standby Mode are set to No at the factory. To change the Remote Pause setting to Yes, press anywhere within the row; the Remote Pause dialog displays.

Figure 63: Remote Pause

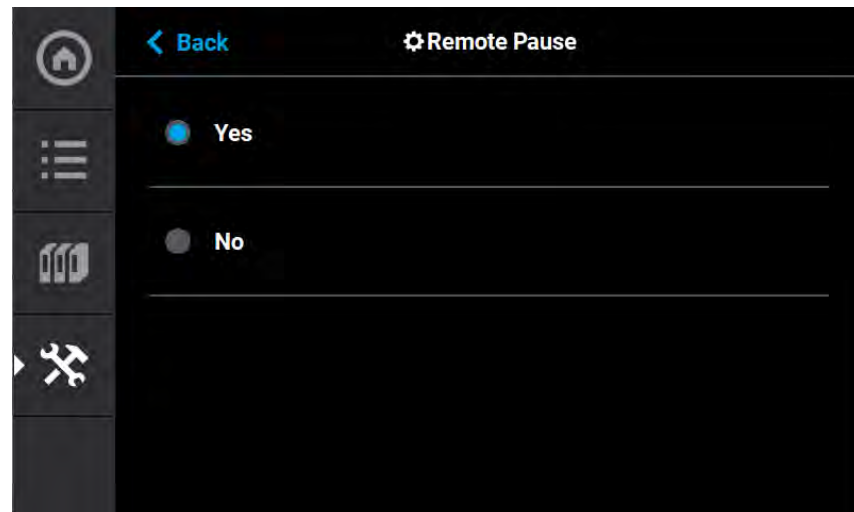

Setting the Remote Pause radio button to Yes allows for pausing the build via the GrabCAD Print mobile application and a cellular phone. Once the build is paused, it cannot be restarted remotely. The build restart must be physically performed on the printer.

The printer can also be remotely set to Standby mode using the Remote Set Standby screen and the GrabCAD Print mobile application.

Figure 64: Remote Access Permissions Dialog

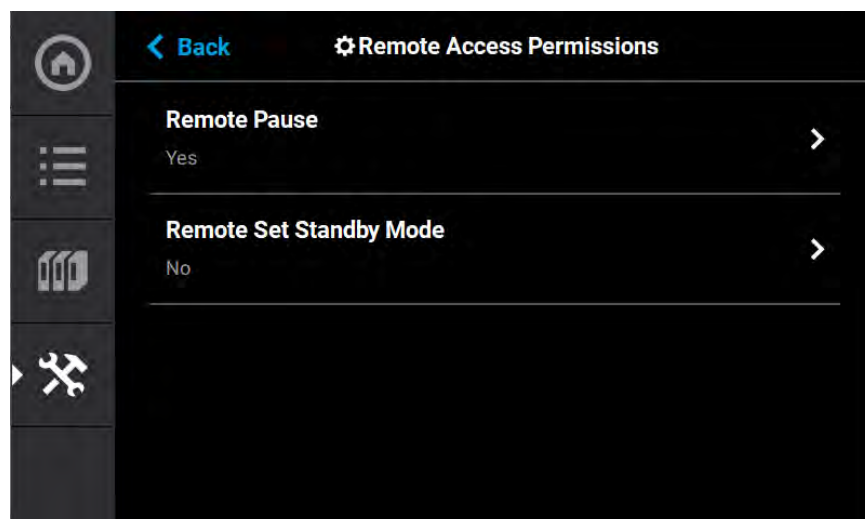

To change the Remote Set Standby setting to Yes, press anywhere within the row; the Remote Set Standby dialog displays.

Figure 65: Remote Set Standby

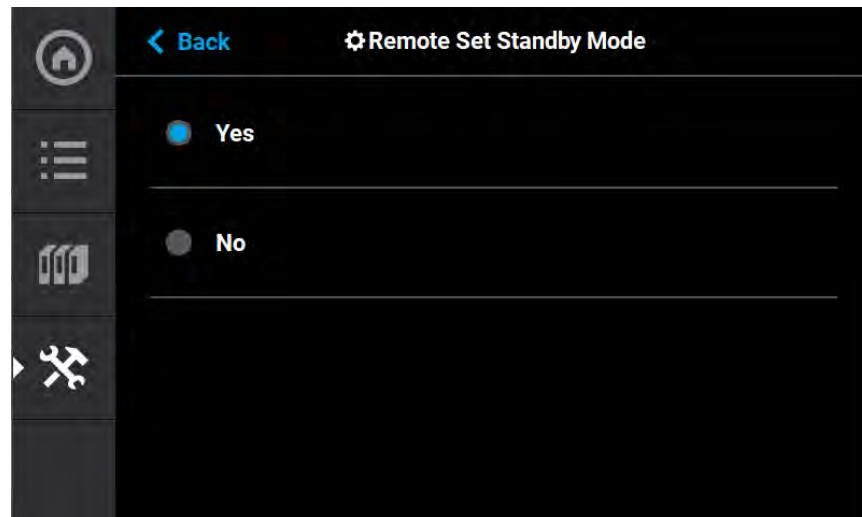

Setting the Remote Set Standby radio button to Yes allows for setting the printer to Standby mode via the GrabCAD Print mobile application and a cellular phone. Once the printer is set to Standby mode, the printer mode cannot be changed remotely.

## Calibration



This section provides an overview of the Calibration page and its features, but does not go into detail regarding calibration procedures. See “6 Calibration and Adjustments” (page 140) for detailed calibration procedure information and instructions.

The Calibration page allows you to perform a variety of calibration procedures on the printer, including:

- Tip Calibration
- Touchscreen Calibration

To access the Calibration page, press the **Calibration** button within the Tools page; a screen similar to the following will be displayed.

Figure 66: Calibration Page

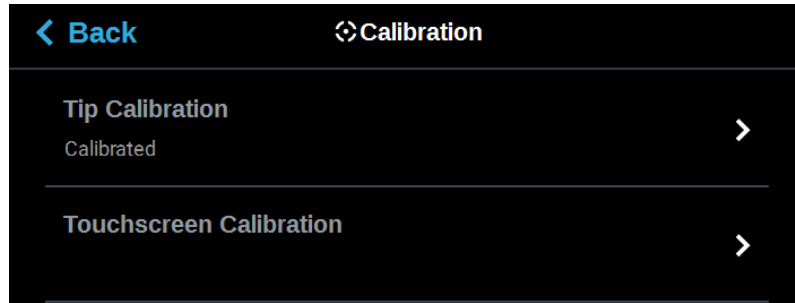

## Tip Calibration

The printer's calibration status will be displayed within the Tip Calibration row. Calibrated or Not Calibrated will be displayed depending on the printer's Calibration status.

Pressing anywhere within the Tip Calibration row will open a page allowing you to select from a variety of tip calibration options.

Figure 67: Tip Calibration

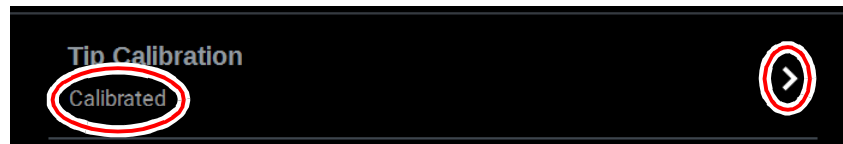

The Tip Calibration page contains an option for performing an Automatic Tip Calibration as well as a Manual Tip Calibration. Pressing the **Start** button associated with either of these options will allow you to perform that particular calibration procedure. Each calibration procedure is

delivered in the form of a wizard which will guide you through the process of performing the calibration procedure. See “Automatic Tip Calibration” (page 141) and “Manual Tip Calibration” (page 144) for detailed instructions.

Figure 68: Tip Calibration Options

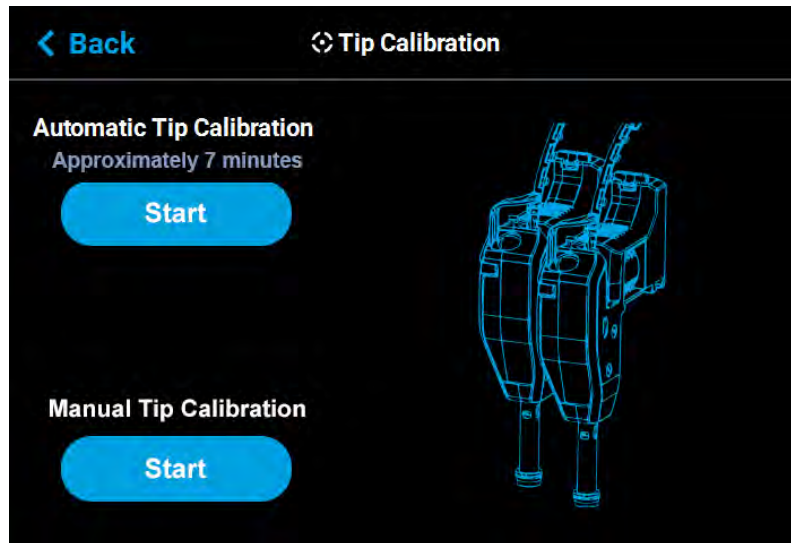

### Touchscreen Calibration

Pressing anywhere within the Touchscreen Calibration row will open a dialog allowing you to recalibrate the touchscreen display. See “Touchscreen Calibration” (page 153) for detailed instructions.

Figure 69: Touchscreen Calibration

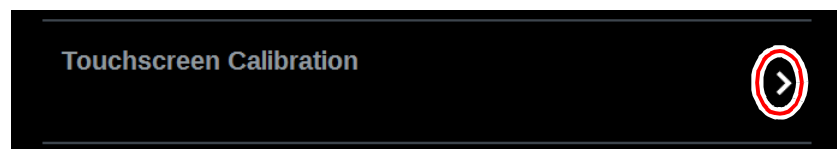

## Maintenance



This section provides an overview of the Maintenance page and its features, but does not go into detail regarding printer maintenance procedures. See [Chapter , 7 Maintenance](#) (page 158) for detailed maintenance information.

From this page you can perform a variety of maintenance procedures on the printer, and view diagnostic/printer state information. Please note that advanced maintenance must be performed by an authorized service representative only.

To access the Maintenance page, press the **Maintenance** button within the Tools page; a screen similar to the following will be displayed.

Figure 70: Maintenance Page

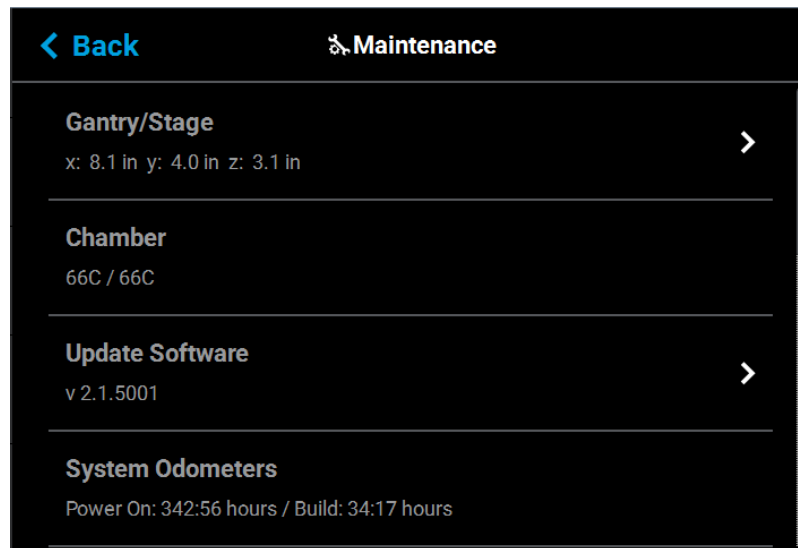

### Gantry/Stage

Position information for the X, Y and Z axes is displayed within the Gantry/Stage row. Pressing anywhere within the Gantry/Stage row will open the Gantry/Stage page.

Figure 71: X, Y, Z Position

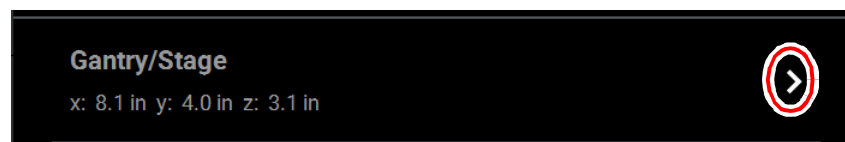

The single directional arrow button within the **Gantry**: section allows you to move the head in the X and Y axis. Pressing the **Front Arrow** button moves the head assembly to the front of the gantry.

The two directional arrow buttons within the **Stage:** section allow you to move the platen (Z) up or down.

- Up: pressing the **Up Arrow** button moves the Z stage to the mid-Z position.
- Down: pressing the **Down Arrow** button moves the Z stage to the lower-Z position.

The information displayed within the Positions portion of the page will update to reflect X, Y, and Z positioning changes made using the directional arrow buttons.

Figure 72: Gantry/Stage Page

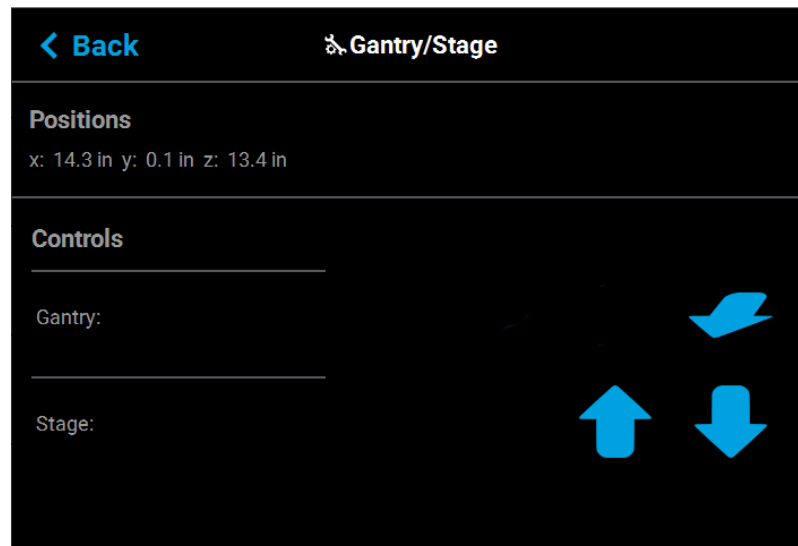

## Chamber

The Chamber row displays the current temperature as compared to the set point temperature of the oven chamber.

Figure 73: Chamber Temperature





## Update Software

The Update Software row displays the version of Controller Software installed on the printer.

Figure 74: Update Software

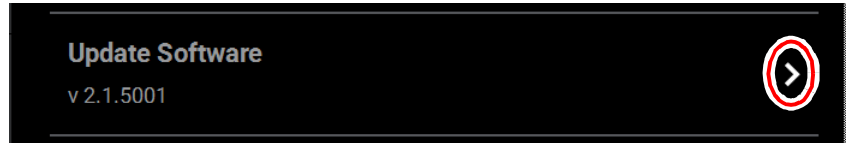

Pressing anywhere within the Update Software row will open a page allowing you to upgrade the printer's Controller Software version (see "Updating Controller Software" (page 158) for details).

Figure 75: Update Controller Software Page

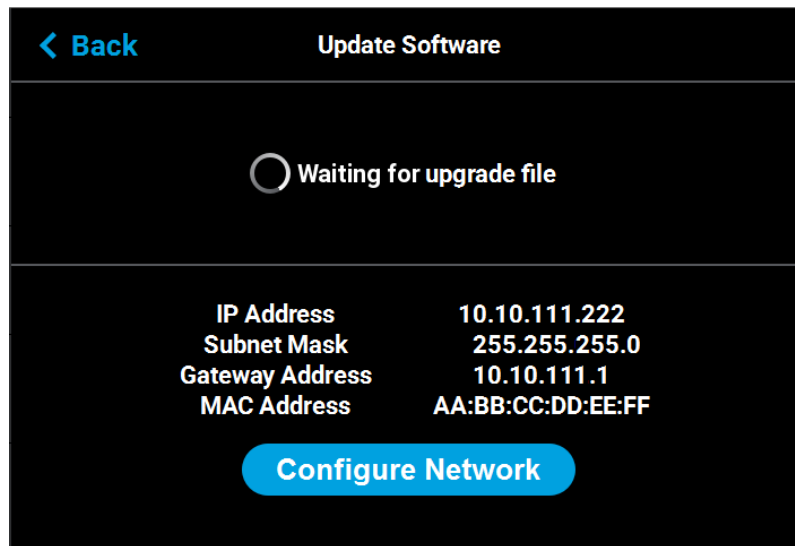

## System Odometers

The System Odometers row displays the number of hours in which the printer has been building.

Figure 76: System Odometers

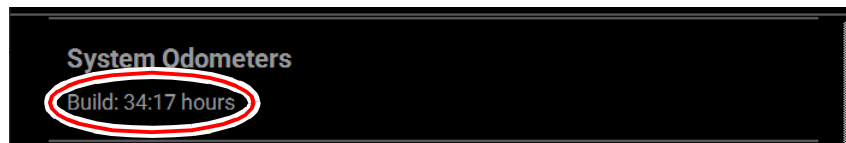

## Serial Number

The Serial Number row displays the printer's unique serial number. This number can also be found on the label on the exterior surface of the printer (see Figure 3 (page 9) for serial number tag label placement).

Figure 77: Serial Number



## Open Source Licenses

Pressing anywhere within the Open Source Licenses row will open a page displaying legal information pertaining to the open source software running on the printer. The files displayed are read-only.

Figure 78: Open Source Licenses



## System Type

The System Type row displays the printer's model type information F120.

Figure 79: System Type

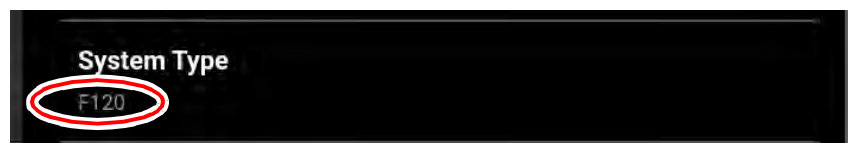

## USB Tools

Pressing anywhere within the USB Tools row will open a page allowing you to:

- upgrade the printer's Controller Software version from an installed USB Flash drive (see "Updating Controller Software" (page 158) for details).
- export the system configuration file to an installed USB Flash drive (see "Exporting System Configuration (.CFG) File" (page 162) for details).

Figure 80: Update Software



## Network



Your printer was configured for your network as a part of its initial installation and setup (see “Configuring the Network” (page 10)). The information within this section is provided to help you understand the functionality of the Network portion of the Settings page.

Within the Network page you can configure your printer’s network connection, options include Static, Dynamic (default), or Wi-Fi. The network type selected will determine the rows and configurable settings displayed within the Network page.

To access the Network page, press the **Network** button within the Tools page; a screen similar to the following will be displayed.

Figure 81: Network Page

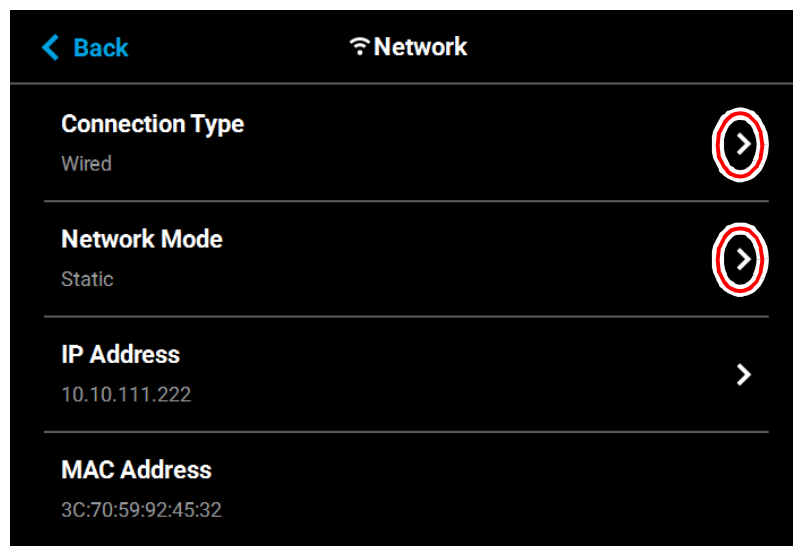

Pressing anywhere within the Connection Type row will allow you to select between a wired (Static or Dynamic) or wireless (Wi-Fi) network; Wired is selected by default. Use the **Wired** and **Wireless** radio buttons to select a connection type. After selecting a connection type press

the **Back** button to exit and return to the Network page; the selected connection type will be indicated within the Connection Type row (see [Figure 83 \(page 92\)](#) and [Figure 84 \(page 92\)](#) as a reference).



The Wireless connection type option will only be displayed if a Wi-Fi dongle has been installed and the printer's Wifi setting is set to On (see "Wifi" (page 79) for details). If a dongle has not been installed, or if a dongle has been installed but the printer's Wifi setting is set to Off, this row will be hidden from view and you will not have the option of configuring a Wi-Fi network.

Figure 82: Select Connection Type

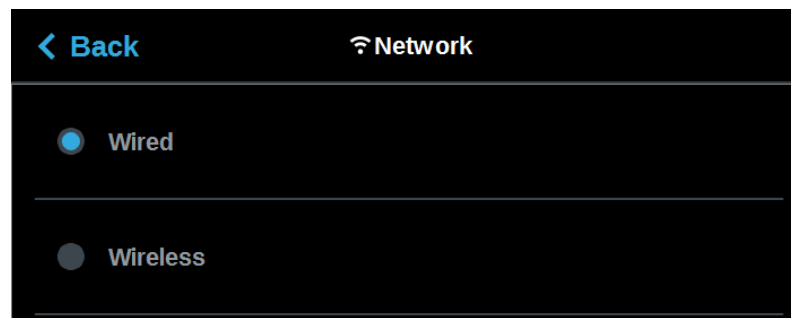

Depending on the Connection Type selected (Wired or Wireless) the second row displayed within the Network page will vary.

- If the Wired connection type is selected, the Network Mode row will be displayed.
- If the Wireless connection type is selected, the Available Networks row will be displayed.

See the detailed information in the sections below for specific information on the available connection types.

Figure 83: Network Page - Network Mode Row

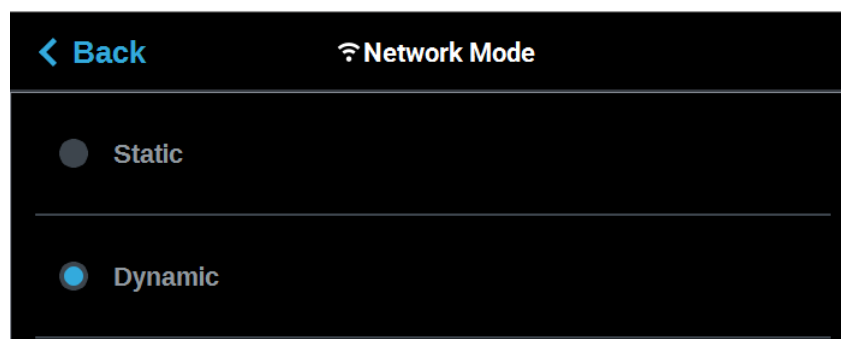

Figure 84: Network Page - Available Networks Row



If the Wired connection type is selected, the Network Mode row will be displayed (see Figure 83 (page 92) as a reference). Pressing anywhere within this row will allow you to select between a Static or Dynamic network mode; Dynamic is selected by default. Use the **Static** and **Dynamic** radio buttons to select a network mode. After selecting a network mode press the **Back** button to exit and return to the Network page; the selected network mode will be indicated within the Connection Type row.

Figure 85: Select Wired Network Mode



If the Wireless connection type is selected, the Available Networks row will be displayed (see Figure 84 (page 92) as a reference). Pressing anywhere within this row will open a page allowing you to scan for and connect to an available Wi-Fi network. After selecting an available

network, entering the password and/or username required to connect to the network (if applicable), and saving the network configuration, press the **Back** button to exit and return to the Network page; the name of the selected wireless network will be indicated within the Available Networks row.

Figure 86: Select Wireless Network Mode



### **Dynamic Network Configuration**

When the **Dynamic** (DHCP) wired network option is enabled a network server or PC will generate an IP address for the printer. A different IP address may be generated from time to time by the server or PC. The generated IP address will be displayed within the IP Address field, and corresponding Subnet Mask, Gateway Address, and MAC Address information will also be displayed.

When finished, press the **Back** button to exit and return to the Tools page.

Figure 87: Dynamic Network Configuration

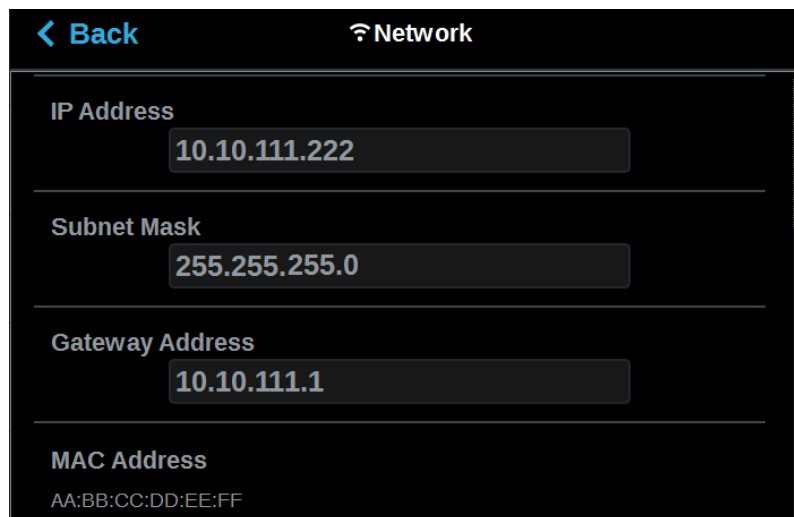

### Static Network Configuration

When the **Static** wired network option is enabled you must manually configure the IP Address, Subnet Mask, and Gateway Address fields for the printer (provided by the system administrator). Use the keypad to configure this information; simply touch a field on the screen to select it and then use the keypad displayed to enter network information. Touch anywhere on the screen outside of the keypad to exit and close the keypad. Press the **Apply** button to save the network information configured. Once the Apply button has been pressed and network information is saved, network information will not change.



See your system administrator if you do not know the IP address, Subnet Mask, or Gateway Address.

When finished, press the **Back** button to exit and return to the Tools page.

Figure 88: Static Network Configuration

A screenshot of a mobile application interface for network configuration. The screen has a dark background with white text. At the top left is a blue back arrow and the word 'Back'. At the top right is a Wi-Fi icon and the word 'Network'. Below this are three input fields. The first is labeled 'IP Address' and contains the text '10.10.112.222'. The second is labeled 'Subnet Mask' and contains '255.255.255.0'. The third is labeled 'Gateway Address' and contains '10.10.112.1'. Each field is a rounded rectangle with a light gray border.

### Wi-Fi Network Configuration

When the wireless network option is enabled you can scan for and connect to the printer via your local **Wi-Fi network** (see Figure 86 (page 93)). Depending on the network's security requirements you may need to enter a password and/or username in order to connect to the network. Use the keypad to configure this information; simply touch a field on the screen to select it and then use the keypad to enter network security information. Touch anywhere on the screen outside of the keypad to exit and close the keypad. Press the **Connect** button to save the network information configured. Once the Connect button has been pressed and network information is saved, network information will not change.

Press the **Back** button to exit the page and return to the Network page; the The name of the selected wireless network will be displayed within the Available Networks row.

Figure 89: Wi-Fi Network Page

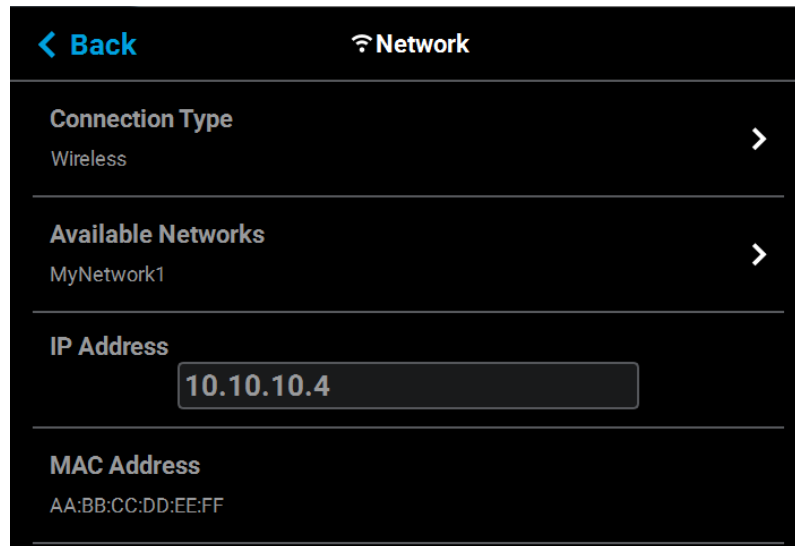

Press the **Back** button to exit the page and return to the Tools page. The Network button will refresh and a blue indicator will be displayed indicating that the printer is configured for a Wi-Fi network.

Figure 90: Enter Network Settings Dialog





## Power

Within the Power page you can restart or shutdown the printer. It is recommended that you use the Shutdown option within this page to power the printer Off, rather than simply pressing the Power ON/OFF button located on the front of the printer.

To access the Power page, press the **Power** button within the Tools page; a screen similar to the following will be displayed.

Figure 91: Power Page

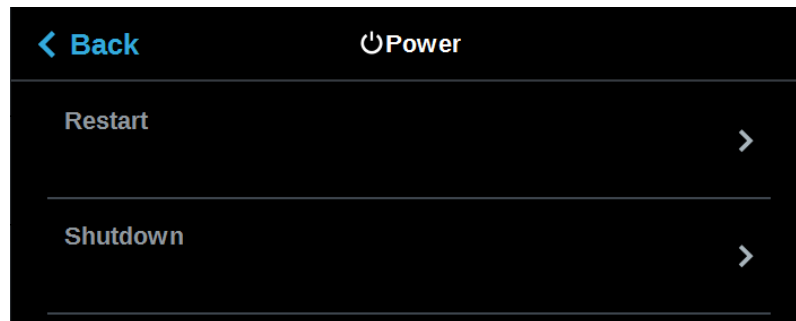

## Restart

Pressing anywhere within the Restart row will open a dialog allowing you to manually restart the printer.

Figure 92: Restart

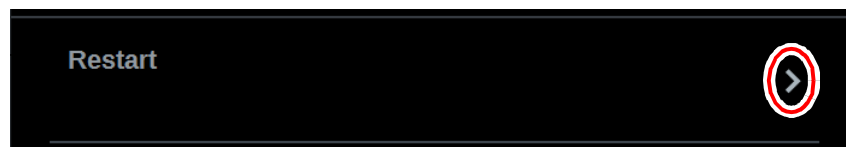

Pressing the **Yes** button within this dialog will cause the printer to restart automatically. Press the **Back** button to exit the page and return to the Power page.

Figure 93: Restart Confirmation Dialog

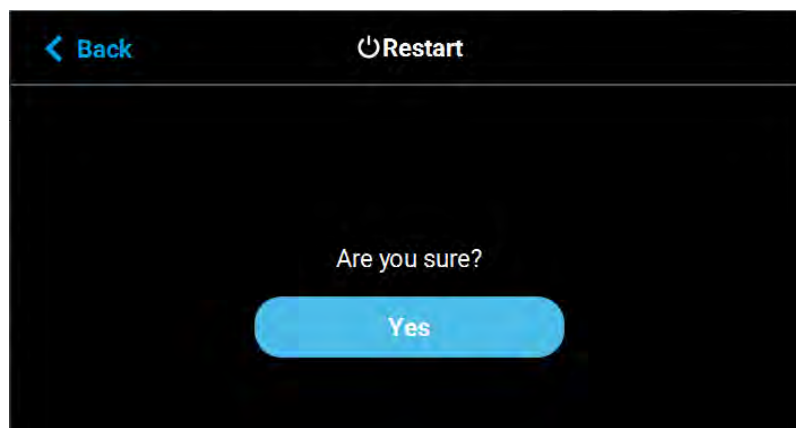

## Shutdown

Pressing anywhere within the Shutdown row will open a dialog allowing you to power the printer down.

Figure 94: Shutdown

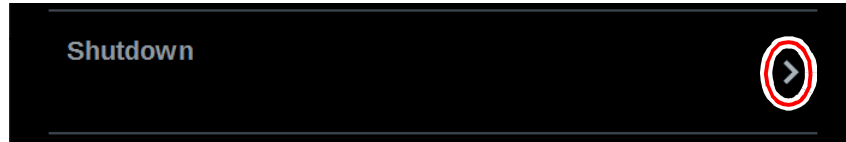

Pressing the **Yes** button within this dialog will cause the printer to power down. Press the **Back** button to exit the page and return to the Power page.

Figure 95: Restart Confirmation Dialog

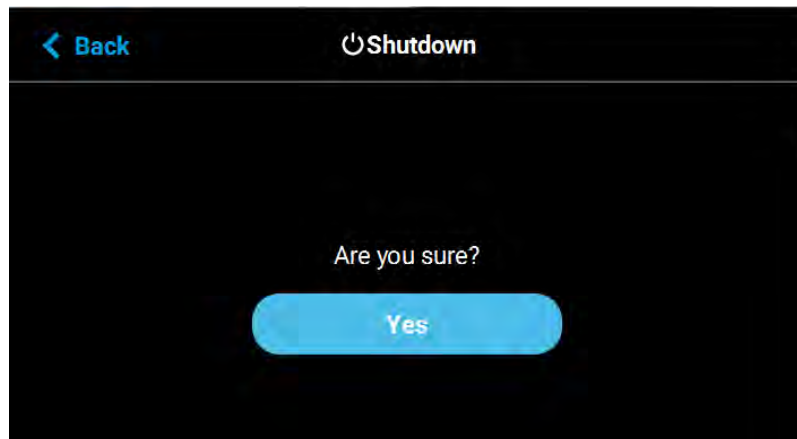

## Light

The Light button is the only option within the Tools page that does not open a new page after being pressed. Instead, the Light button allows you to turn the oven light ON and OFF. An indicator within the upper-left corner of the button displays the current state of the oven light (ON or OFF). The Light button can appear in the following states:

Table 13: Light Button - Button States

Button State	Description
	Oven light is ON. Selecting the Light button in this state will turn the oven light OFF.
	Oven light is OFF. Selecting the Light button in this state will turn the oven light ON.

# 5 OPERATING THE PRINTER

This chapter explains basic steps in operating the F120 printer

## Basic User Operations

### Powering ON the Printer

To power the printer ON:

1. Connect the male end of the supplied power cord directly into a grounded electrical outlet.
2. Connect the female end of the power cord directly into the socket located on the back of the printer (see Figure 4 (page 10) for location).
3. Press the power button located on the front of the printer.

Figure 1: Power Button Location

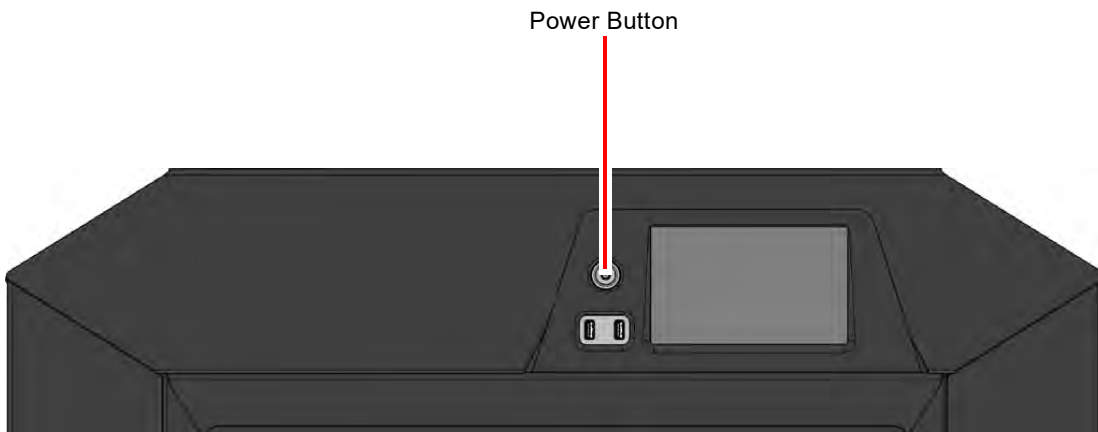

4. The printer will begin to boot. The touchscreen will turn on and begin initializing.
5. The first time the printer is powered ON a dialog will be displayed asking you to select your desired language. Select the radio button corresponding to your desired language by touching its row on the screen, then confirm your selection.

Figure 2: Initializing Start Up Screen

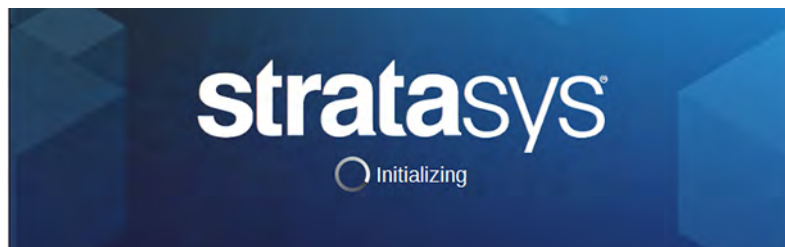

6. After the initialization and start up process is complete, the touchscreen will refresh to display the Build page and the printer will automatically perform an XY Gantry Calibration (see “XY Gantry Calibration” (page 155) for details).

Figure 3: Build Page

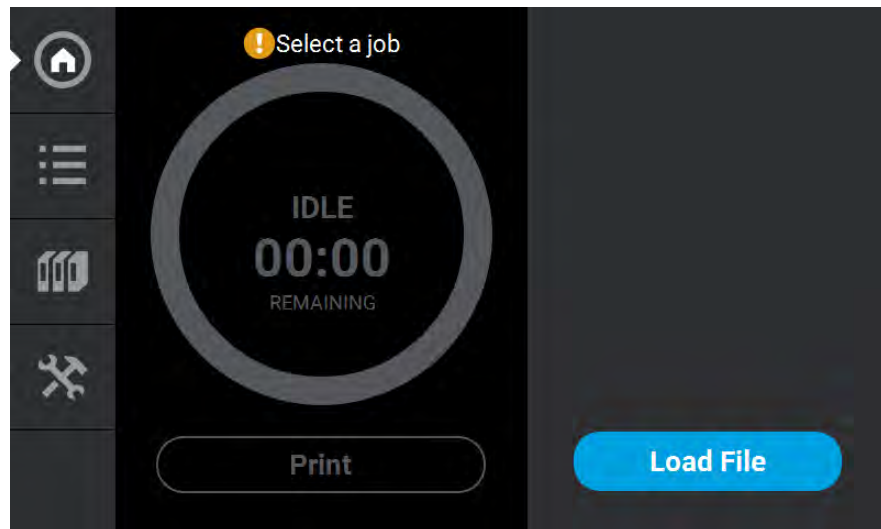

## Powering OFF the Printer

To power the printer OFF:

1. Ensure that the printer is stopped (idle) and is not building.
2. Press the power button located on the front of the printer (see Figure 1 for button location).
3. A dialog will be displayed asking you to confirm the power OFF; press **Yes** to power OFF.

Figure 4: Power OFF Confirmation

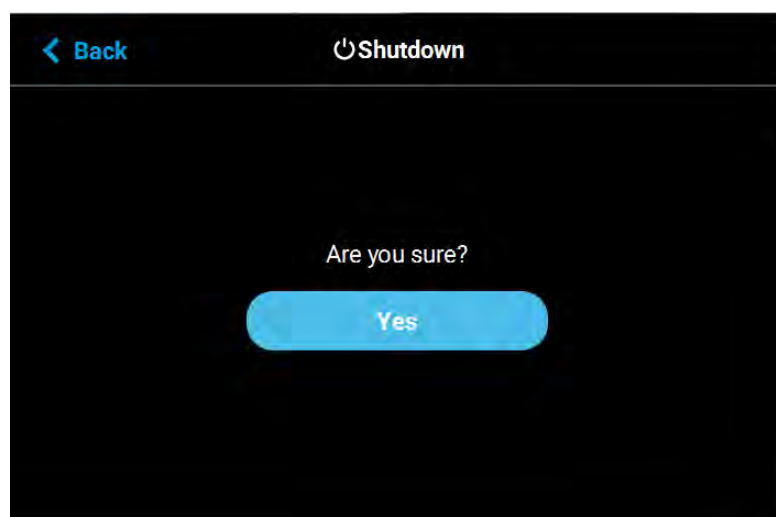

4. After a couple of minutes the printer will shutdown.

Please note that this procedure only powers down the electronics. To completely disengage power to the printer, you must unplug the power cord located at the rear of the printer.



For extended non-use periods greater than 72 hours, unload the material, store the material in an air tight bag and power OFF the system.

## Loading Material

The information within this section will walk you through the process of loading material to the model and support heads. As you complete the required steps, be sure to observe the status information displayed on the touchscreen.



**Caution:**

If the printer remains idle for more than 72 hours, leaving material in the filament tubes could result in a part quality issues due to wet filament. failed build. To prevent this:

- Remove filament from the tubes.

Or

- Unload filament and cut six feet of material from the material coil box.



Loading material can only be done when the printer is stopped (idle) and is not building.

The “Material Coil Box Preparation” (page 100) section describes the steps necessary to prepare a material coil box for use, and highlights the components of the material coil box. Once a material coil box has been prepared for use, the steps within the “[Connecting Material Coil Box To Printer](#)” section will guide you through the process of connecting a material coil box and loading material to the head.

Two material coil boxes, one for model and one for support, must be connected to the F120 in order for it to build.

## Material Coil Box Preparation

When preparing a material coil box, open the box and route the material tube and filament key through the material routing notches. Close the box. Once the filament tube and key are routed, pull the end of the filament until approximately 1.2 meters of material are outside the

material tube. Cut the 1.2 meters of filament using the 5" cutter included in the Welcome Kit. This length of material is removed for moisture control. Refer to [Figure 5](#) for material coil box details.

Figure 5: Material Coil Box Details

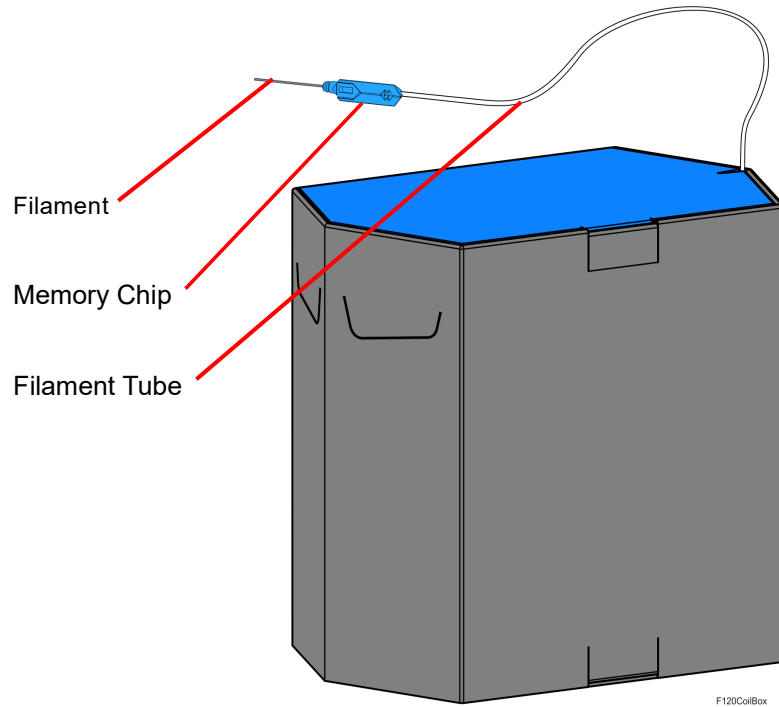

The material coil box is ready to be connected to the printer. Follow the steps in “[Connecting Material Coil Box To Printer](#)” (page 101) to connect the material coil box and load material to the head.

## Connecting Material Coil Box To Printer

Once you’ve properly prepared a material coil box, you can begin the process of loading material. Pre-loading filament to the drive wheels places the filament into position to be loaded to the liquefier tip within the head.

To connect and load material from a material coil box:

1. Ensure that the printer is stopped (idle) and is not building.
2. Select the **Materials** button from the Navigation Menu; a screen similar to [Figure 6 \(page 102\)](#) will be displayed. The information displayed represents the current configuration of your printer.

Figure 6: Current Configuration - Load Material

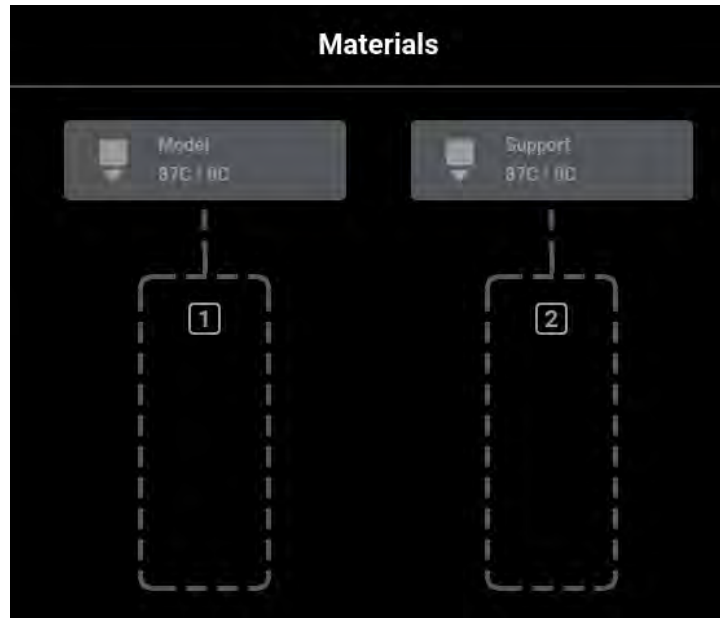

3. Click inside the grey outlined box for the material type (Model or Support) you wish to load. A screen similar to displays. Click the Load button.

Figure 7: Current Configuration - Load Model Material

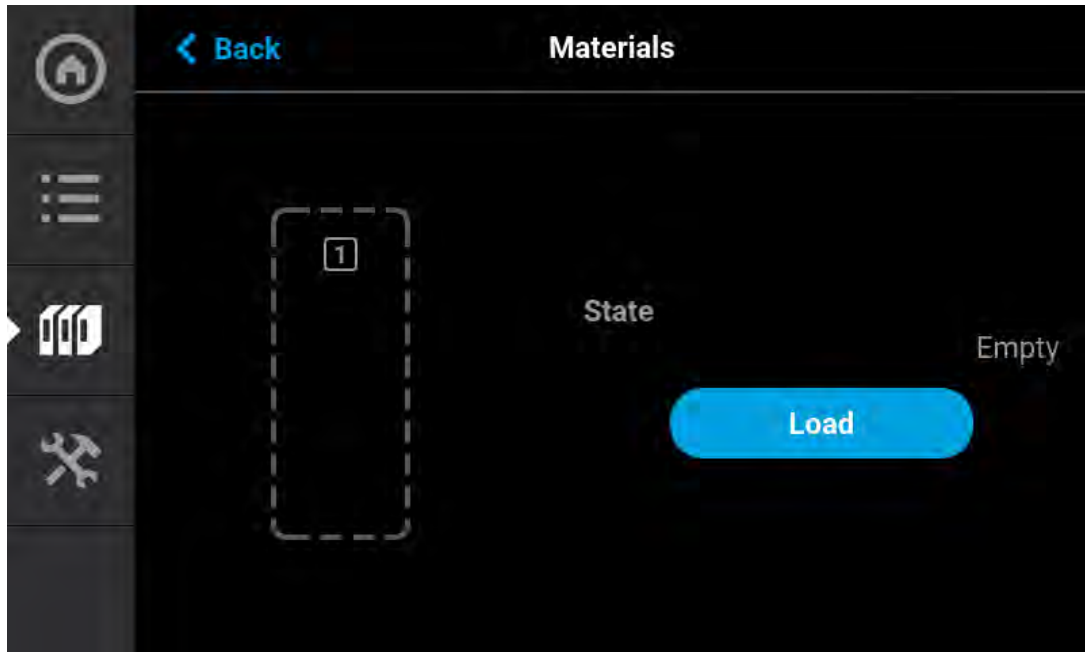



4. Clicking the Load button activates the F120 Material Load Wizard. The screen below displays.

Figure 8: Load Material Wizard Screen

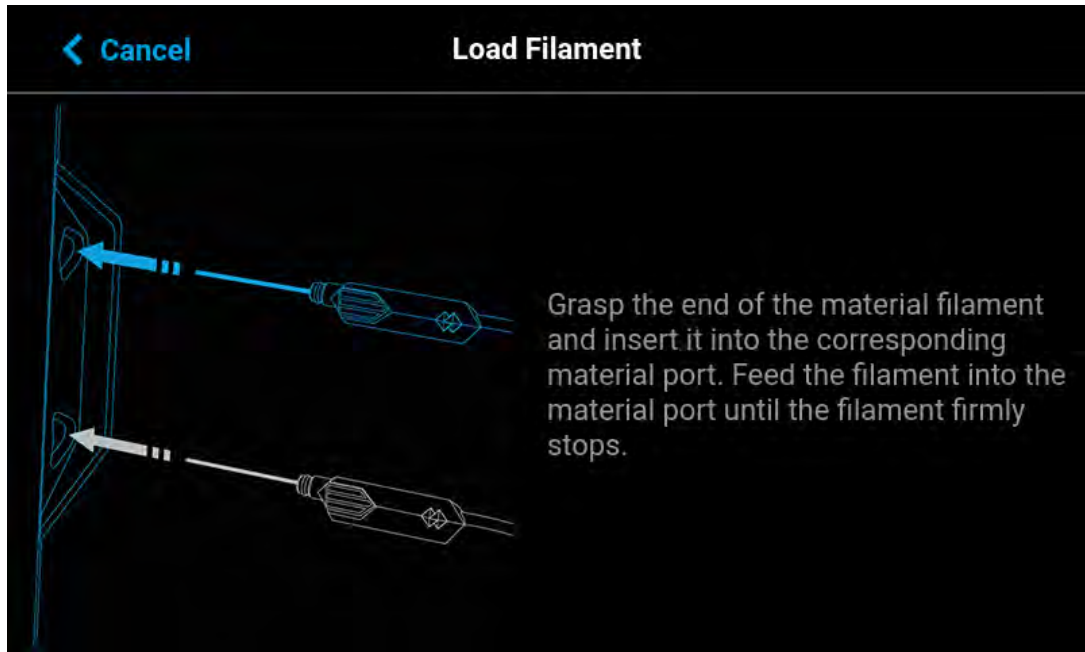

5. Grasp the end of the material filament and insert it into the corresponding material port (see [Figure 9](#)). Feed the filament into the material port until the filament firmly stops. At this point, the machine will begin to feed the material into the liquefier.

Figure 9: Material Ports



6. Material begins to load to the liquefier tip within the head. The pathway displayed between the Material Status Icon and the corresponding Head Status Icon becomes highlighted to indicate load progress (see [Figure 32 \(page 67\)](#)).
7. When filament reaches the head, it enters the liquefier tip and begins to warm to the material operating temperature (automatic - based on material coil box memory chip data). This step also sets the oven temperature to the correct value for the material being loaded.
8. Once the tip is within three degrees of the set point temperature the head moves to the purge area and the tip purges a small amount of material.

9. Insert the filament key into the corresponding slot. While the material is loading, a screen similar to the one shown below will display.

Figure 10: Material Loading

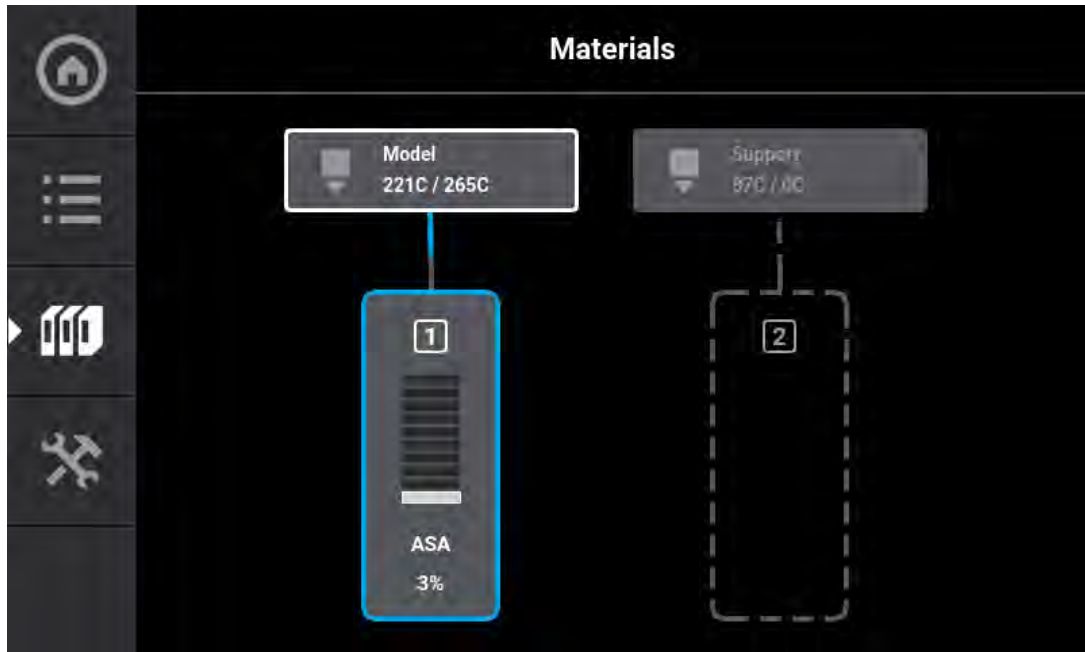

10. When the load process is complete, a screen similar to the one shown below will display. Material is now loaded to the print head.

Figure 11: Material Loaded

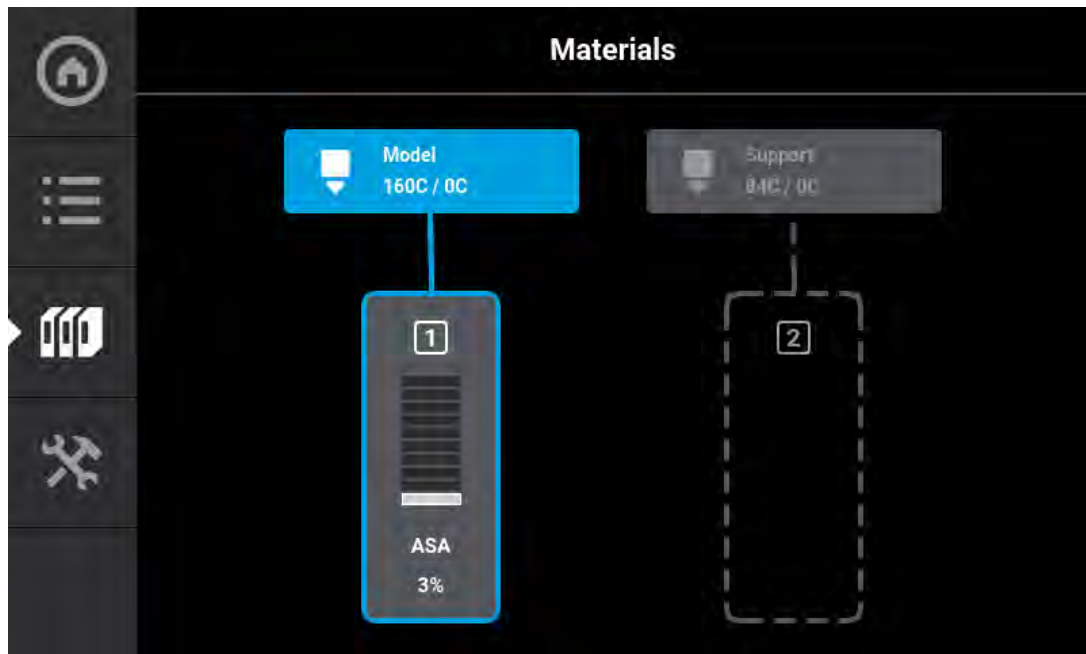

Only one material can be loaded at a time.

11. Press the **Back** button within the Material Details page to exit and return to the Materials page.
12. If necessary, perform this procedure for the support material
13. Once material is loaded, the filament pathway between the Material Status Icon and the corresponding Head Status Icon will be solid blue, the Head Status Icon will turn from gray to blue, and the Material Status Icon will display a solid blue border.

You are now ready to select a job to build, see “Basic Job Build Tasks” (page 113) for information on selecting and starting a job.

# Unloading Material

**Caution:**

If the printer remains idle for more than 72 hours, leaving material in the filament tubes could result in a part quality issues due to wet filament. To prevent this:

- Unload filament and cut 1.2 meters of material from the material coil box
- Cut the filament approximately 5 centimeters from the end of the filament key. Bend the filament 90 degrees to prevent filament from retracting into the key.
- When re-loading material, pull the end of the filament until approximately 1.2 meters of material are outside the material tube and cut the filament at this point.

Perform the following steps to unload material:

1. Ensure that the printer is stopped (idle) and is not building.
2. Select the **Materials** button from the Navigation Menu; a screen similar to [Figure 12 \(page 109\)](#) will be displayed. The information displayed represents the current configuration of your printer.

3. Observe the status information displayed for each of the Materials Status Icons. For a loaded material, the pathway between the material's Material Status Icon and corresponding Head Status Icon will be solid blue, the Head Status Icon will be blue, and the Material Status Icon will display a solid blue border.

Figure 12: Current Configuration - Unload Material

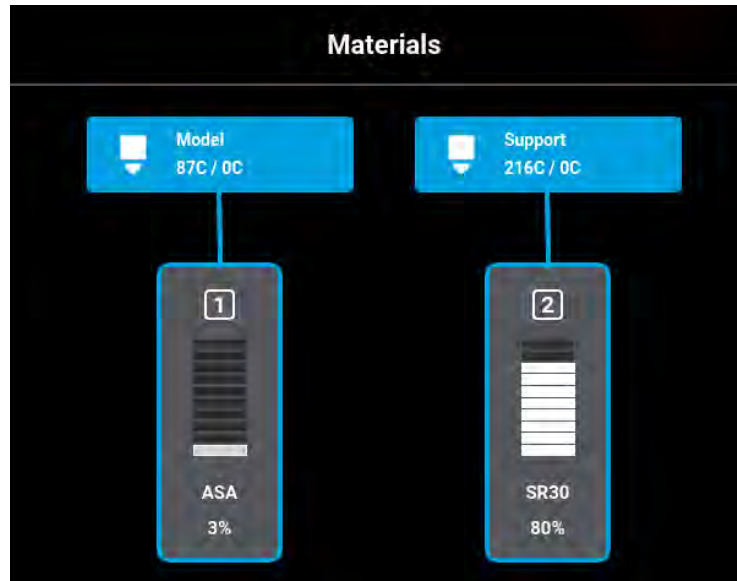

4. Open the Material Details page corresponding to the material you want to unload by touching its Material Status Icon on the screen.
5. Press the **Unload** button within the Material Details page.

Figure 13: Unload Button





 Only one material can be unloaded at a time.

6. The F120 unload material wizard initializes and material begins to unload from the head. The unload process will take several minutes; please be patient.
  - The pathway displayed between the Material Status Icon and the corresponding Head Status Icon becomes highlighted to indicate unload progress (see Figure 32 (page 67)).
  - The Head Status Icon will refresh and become solid gray, indicating that material is no longer loaded to the head.
7. When the material is unloaded from the head and the F120 material unload wizard has completed its process. See Figure 15 (page 110).
  - Remove the filament key from the material port.

- Cut the filament approximately 5 centimeters from the end of the filament key. Bend the filament 90 degrees to prevent filament from retracting into the key. See Figure 14 (page 110).
- Extract the remaining filament from the material port and discard.

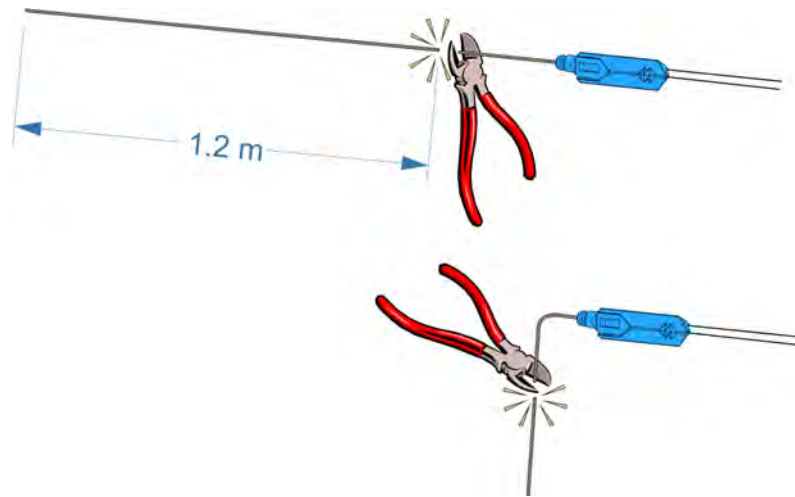
Figure 14: Cut Filament After Unloading



8. Open the material coil box and insert the filament key and filament tube. Close the material coil box.

Figure 15: Material Unloaded Screen

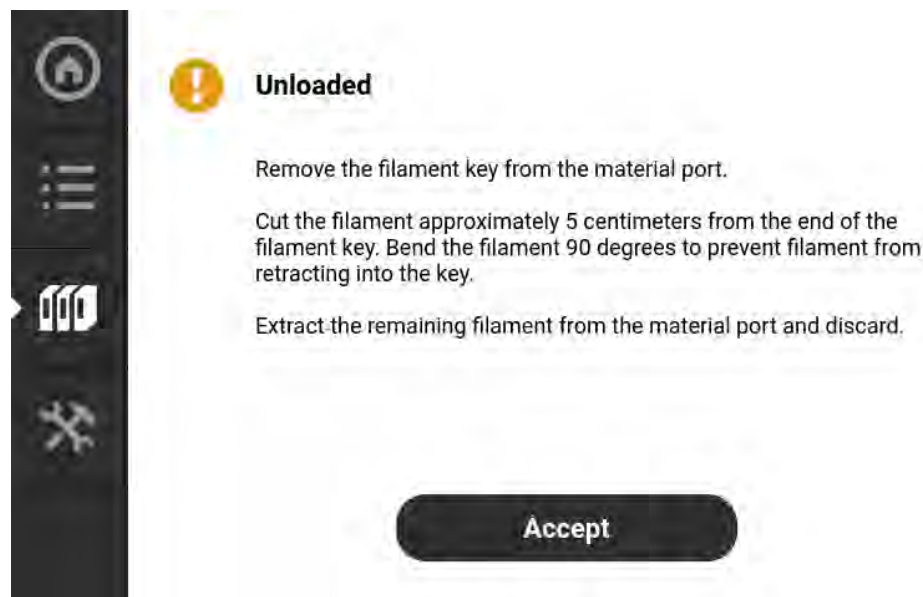

At this point you have the option of loading a different material into the printer or reloading the material you just unloaded (see “Loading Material” (page 100) for detailed instructions).



Empty material coil boxes may have a small, unusable volume of material remaining. The leftover material allows for manufacturing tolerances.

## Handling/Storing Materials

Stratasys FDM thermoplastic materials will maintain proper product performance over an extended period of time, when handled and stored according to recommended procedures. Like other thermoplastics, the filament can absorb moisture when exposed to ambient humidity. Stratasys material coil boxes are designed to minimize moisture exposure while unopened and opened. When a filament absorbs moisture a finished part's surface quality, seam quality, and overall part aesthetics can be affected. Care should be taken to ensure filament remains dry.



**Caution:**

Material storage shall be in the range of 55°F to 86°F (13°C to 30°C), with relative humidity less than 70%.

The model and support material coil boxes hold 200 in<sup>3</sup> (3277 cc) of filament.

Material coil boxes also contain desiccant material; the desiccant is designed to maintain proper moisture levels within the material coil box. Once the desiccant is exposed to ambient air, it can become saturated and ineffective for moisture control. Proper handling of the material coil box is essential to maximizing material life.

## Head Replacement

When a head reaches the 1500 build hours odometer limit, a warning will be displayed on the User Interface and the head's Head Status Icon will be highlighted in red on the Materials page. You can continue using a head which has exceeded its odometer limit, but it is highly recommended that you change the head as part quality will be unpredictable.

## Replacing a Head

The information within this section is meant to guide you through the process of changing a head. Although the instructions below depict the replacement of the model head, the same procedure applies to the support head.



1. Unload material from the head that will be replaced (see “Unloading Material” (page 108) for instructions).
2. With the printer powered ON, open the top cover (see Figure 1 (page 17)).



Replacing a head while the printer is powered ON will ensure that an Automatic Tip Calibration is performed after the replacement process is complete. Power is automatically removed from the head and all motors when the top cover is opened.

3. Depress the release tab and unclip the head ribbon cable for the head that will be replaced.



Do not twist or place rotational force on the head ribbon cable.

4. While gripping only the connector, carefully disconnect the connector from the head.
5. Disconnect the material tube for the head that will be replaced.
6. Unlock the head release lever for the head that will be replaced.

Figure 16: Head Connections

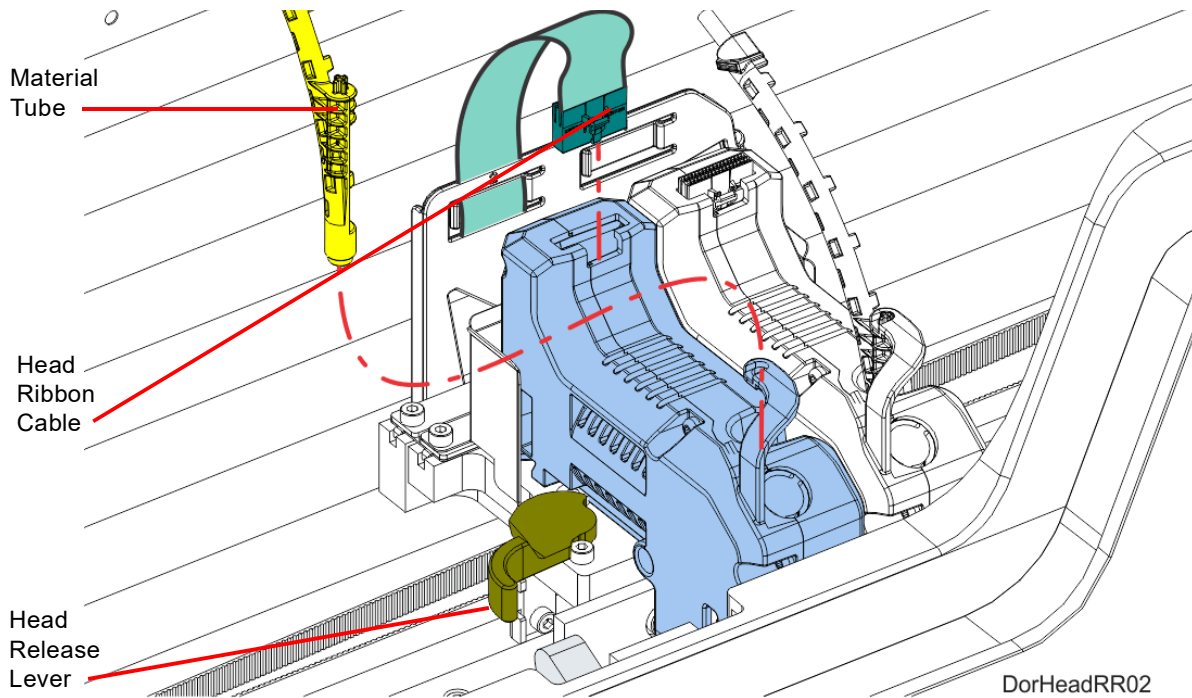

- Pull the head assembly out of its position within the gantry and remove it from the printer.

Figure 17: Remove Head

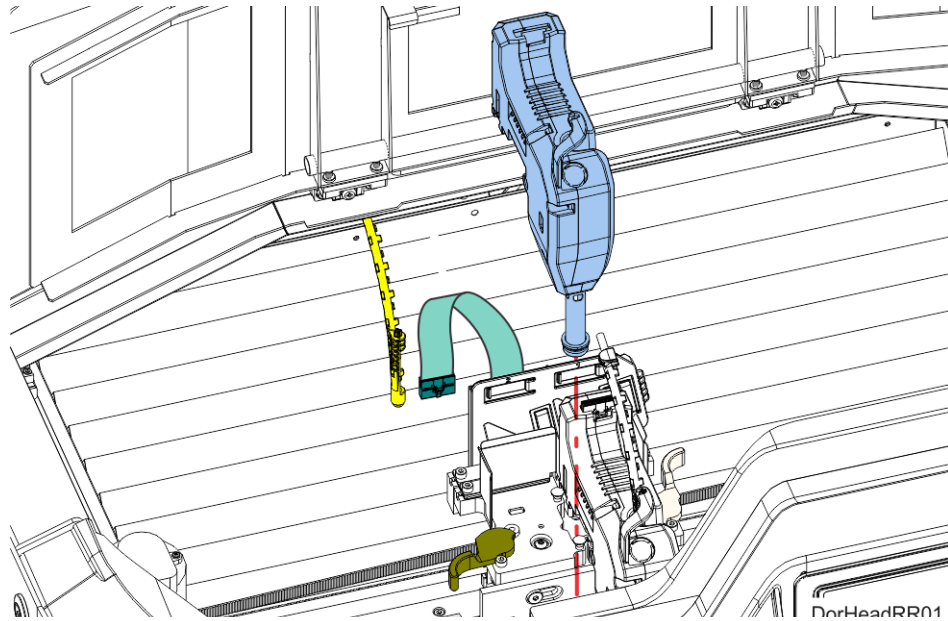

- Insert a new head assembly into the vacant location within the printer.
- Lock the head into place using the head release lever. Press the lever securely closed to ensure that the head is properly seated.
- Connect the material tube to the new head assembly.
- Insert the head ribbon cable connector into the new head assembly ensuring it is fully seated in the head and the connector retention latch engages.
- Close the top cover.
- Perform an Automatic Tip Calibration. See “Automatic Tip Calibration” (page 141) for details. Please note that the printer must be powered ON before calibration can occur.
- Perform a Manual Tip Calibration. See “Manual Tip Calibration” (page 144).

## Basic Job Build Tasks

### Before a Build

To build a job, you must first download job files to the printer and then load individual job files to the Job Queue using one of two methods:

1. Network transfer via the GrabCAD Print application on your workstation PC. This is the preferred method for adding jobs to the Job Queue. See “GrabCAD Print Method” (page 46) for detailed instructions.
2. USB method via a USB flash drive inserted into one of the available USB ports. See “USB Method” (page 46) for detailed instructions.

The GrabCAD Print option allows you to select a job which was processed and sent to the printer (via your facility’s Ethernet connection or via Wi-Fi) using the GrabCAD Print application on your workstation PC. Jobs are sent in CMB format and placed directly into the Job Queue (stored on the printer’s hard drive). The CMB file contains the processed job’s basic information; this information is used to verify job compatibility with the printer’s existing configuration. For information on using GrabCAD Print, see the associated Help file within the GrabCAD Print application.

The USB option allows you to select a job file which is stored on a USB flash drive inserted into one of the available USB ports (see [Figure 3 \(page 19\)](#) for port locations). This method can be used as a backup to the GrabCAD Print method if you are unable to transfer job files to the printer via your network connection (due to poor connectivity, a network outage, etc.) and provides a convenient option for you to reprint a common job. Alternatively, you have the option of selecting a single job file off of a USB flash drive and printing it directly within the Build page. This option is only available if the Job Queue is empty. See “[Loading a File](#)” (page 37) for details.

## Preparing the Printer

To prepare the printer for a build:

1. Power ON the printer (see “[Powering ON the Printer](#)” (page 98) for instructions).



### Warning: Hot Surface Hazard

Wear proper safety equipment when handling items inside the oven as surfaces within the oven can be very hot.

2. Open the oven door.
3. Place a new substrate onto the platen and lock the substrate into its build position by lifting up on the substrate ejection handle.



### Caution:

Always wear gloves when installing the substrate. Hand oils on the substrate surface will result in poor part adhesion.



Never print in the same location more than once on a substrate when building a job.  
Using substrates not provided by Stratasys may impact part quality and printer reliability.

4. Make sure that the tip wipe assembly’s brushes as well as the printer’s tips are clean and that the purge area is free of purged material debris.

## Selecting a Job to Build

1. Populate the Job Queue as described within “Before a Build” (page 113).
2. Select the **Queue** button within the Navigation Menu; the Queue page will open to display the Job Queue.
3. Within the Job Queue list, locate the job you’d like to build and select it by touching its row on the screen; doing so will open its Job Details page.



Jobs are built in the order in which they appear within the Job Queue. To build a specific job, that job must be listed as the first item in the Job Queue. Use the Job Queue Control buttons to sort job files as needed (see “Editing the Job Queue” (page 49) for details).

4. Within the Job Details page press the **Print** button; this will queue the job for printing. Depending on your printer’s part placement setting configuration a dialog may be displayed (see “Part Placement” (page 74)).
  - If the Enable Part Placement setting is set to Off (default setting), a dialog will not be displayed and the job will automatically be built in the center of the substrate.
  - If you set the Enable Part Placement setting to On, a dialog will be displayed allowing you to select the job’s build location (see [Figure 26 \(page 125\)](#)). The dialog contains a graphic representing your printer’s platen as well as a blue bounding box graphic (the imaginary box surrounding the part). Select the job’s build location by dragging and dropping the bounding box on the touchscreen. When finished, press the **Print** button within the dialog to confirm your selected placement and start the build.
5. The Build page will open and the oven will begin to heat to a set point temperature determined by the material types specified for the job. Please be patient.
6. After the oven and liquefier tips reach temperature the printer performs a Z Zero Calibration. "PREPARING" is displayed within the Build Status Display while this calibration occurs.
7. Once Z Zero Calibration is complete the printer begins building the job. "BUILDING" is displayed within the Build Status Display as the part is being built (see “[Information Available During a Build](#)” (page 116)).
8. When finished, text is displayed on the touchscreen indicating that the completed part can be removed from the printer (see “[After a Build is Complete](#)” (page 121)).

## Information Available During a Build

During a build, information pertaining to that build is displayed within two areas of the Build page:

The Print Job Information Panel displays the details of a job, as submitted to the printer from the workstation PC. This information is static and is for reference purposes only. See “Viewing Print Job Information” (page 40) for detailed information.

Figure 18: Print Job Information Panel - Building

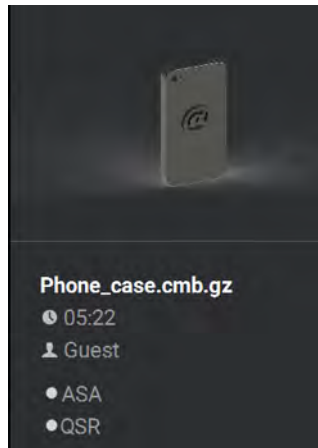

Information displayed within this panel for a selected job includes:

- Name of the job.
- Estimated build time for the job.
- Name of the user that submitted the job.
- Model and support materials associated with the job.

The Build Status Display section of the Build page is composed of a two-part graphic which provides information on a building job. See “Build Status Display” (page 41) for detailed information.

- The Build Status Information portion of this graphic provides information on a selected and/or building job. Text pertaining to the current status of the build is displayed within the upper portion of the graphic, while the amount of build time remaining is displayed within the lower portion of the graphic.
- The outer Build Progress Ring corresponds with the build information displayed. As build progress is made, the build’s percentage of completion is also displayed by radially filling in the outer progress ring, in blue, in a clockwise direction.

- Touching the screen within the center of the Build Status Display while a part is being built will toggle the information displayed. After touching the screen the time estimation information will be hidden from view and instead the Build Status Display will show the number of completed layers as compared to the total number of layers in the build. Touching the screen again, will toggle back to the time estimation information displayed initially.

Figure 19: Print Job Status Overview

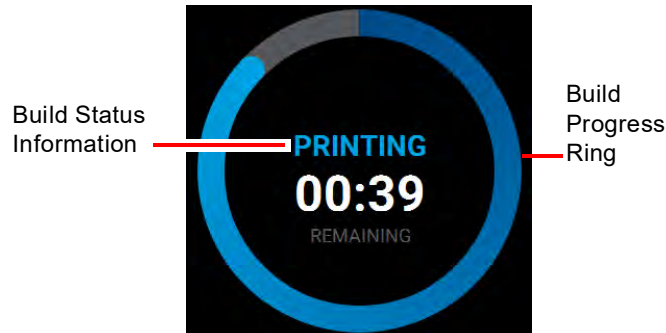

## Build Warnings

If the printer detects an issue that may affect a build, it will be indicated within the Notifications Display portion of the “Build Page” (page 36). A yellow or red notification badge icon will be displayed, depending on the severity of the warning/error, along with text indicating the reason(s) for the warning. Touching the text on the screen will open a dialog indicating the reason(s) for the notification, and in some cases, steps to correct the notification (see Figure 4 (page 36)).

Depending on the type of warning, a notification badge icon may also be displayed within the “Material Status Icons” (page 59) of the “Materials Page” (page 53). Touching the notification badge icon on the screen will open the corresponding material’s Materials Details page and provide information indicating the cause of a warning/error.

- When loading and unloading materials you may encounter load related warnings which need to be resolved prior to starting a build.
- When starting a build you may encounter a variety of warnings pertaining to the printer’s current materials configuration. If the printer has not been calibrated, the materials installed within the printer do not match the requirements of the build, or the printer does not contain enough material to complete the build, you will receive a warning instructing you to resolve this issue.



You can choose to ignore the warning and continue the build, but part build quality will be unpredictable. A warning generated from a mis-match of model/support material cannot be bypassed.

- In some cases, the warning will prevent you from starting a build and will need to be corrected before the printer can build a part.

- While the printer is building, various pause and abort related warnings may be displayed. Some of these warnings may be due to a manual pause or abort, while others may be the result of the printer automatically pausing or aborting a build. Depending on the severity of the warning you may or may not be able to resume building.

See “Warnings and Errors” (page 205) for a detailed list of the warnings you may encounter, and instructions on how to correct them.

## Pausing a Build

During a build the Pause button within the Build page becomes selectable (see “Pause Button” (page 44) for details). The printer can pause automatically, or be manually paused using this button:

- An automatic pause occurs when a material coil box runs out of material, a failure is detected, etc.
- A manual pause occurs whenever the **Pause** button is pressed.

When the printer is directed to pause:

1. The current toolpath is completed, the Z stage is lowered slightly, and then the head assembly is parked. "PAUSED" is displayed within the Build Status Display (see Figure 20).

If an automatic pause occurs, text will be displayed within the Notifications Display portion of the Build Page. Touching the text on the screen will open a dialog indicating the reason for the pause condition (i.e. empty material coil box). Correct this condition and then press the **Close** button to exit the dialog. (See “Build Pause Warnings” (page 211) for a list of pause related warnings/errors and resolution instructions.)

- The Pause button will toggle and instead display the Play button. To resume building, press the **Play** button. A resume command will be sent to the printer instructing it to resume the build (see Figure 20).

 The printer will not resume building instantaneously, please be patient. If the oven door is open the part will not resume building immediately. Touch the text displayed within the Notifications Display portion of the Build page to check for any errors in order to troubleshoot this situation.

Figure 20: Build Paused



- Once the build resumes, "BUILDING" will be displayed within the Build Status Display and the Pause button will be displayed in its unselected state (see Table 3 (page 44)).

## Aborting a Build

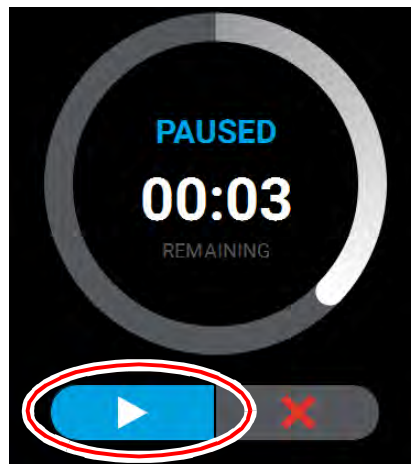
When the printer is building, you have the option of directly aborting the build. To do so:



1. The Abort button within the Build page will be selectable (see “Abort Button” (page 44) for details), press the **Abort** button.
2. A dialog will be displayed allowing you to confirm or cancel the abort; press the **Accept** button within the dialog to confirm the abort.

Figure 21: Abort Confirmation Dialog

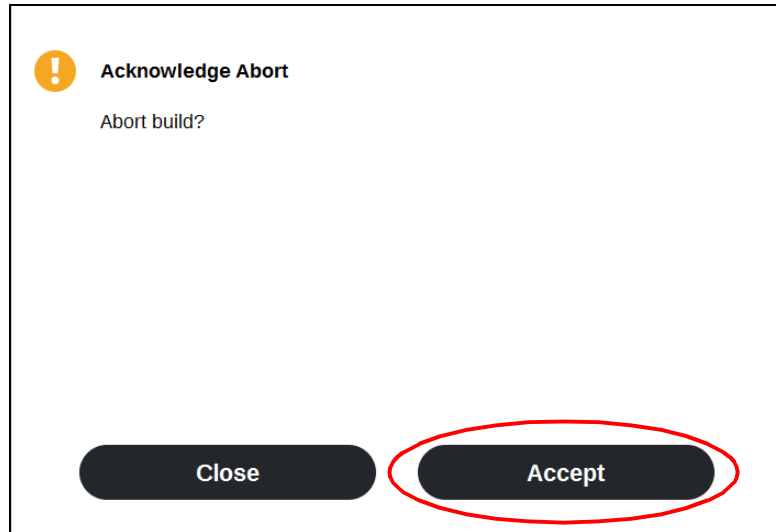

3. An abort command will be sent to the printer and the confirmation dialog will close.
4. The Z stage will move to its end of travel. Once the Z stage reaches its end of travel the Build page will refresh and display a confirmation of the aborted build; "CANCELLED" will be displayed within the Build Status Display (see Figure 22 (page 121)).

5. The Print Job Control buttons will be hidden and instead "Build Cancelled" will be displayed within this portion of the Build page. Touching this text on the screen will open a dialog with instructions on how to remove the aborted build and prepare for your next build (see Figure 22).

Figure 22: Build Page Build Canceled

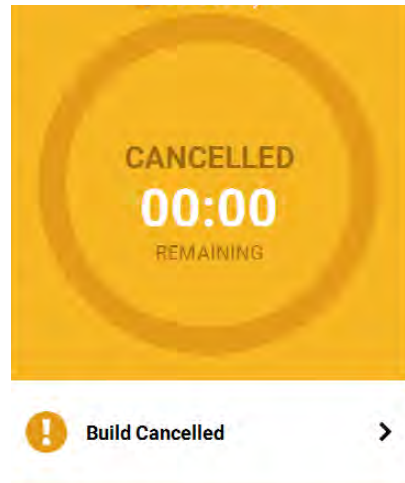

## After a Build is Complete

After the completion of a build, the printer performs the following actions:

- The Z stage is lowered and the head assembly is parked.
- "DONE" is displayed within the Build Status Display (Figure 23 (page 122)).
- The Print Job Control buttons will be hidden and instead "Print successful" will be displayed within this portion of the Build page. Touching this text on the screen will open a dialog with instructions on how to prepare for your next build.

- The Build button will display a green checkmark icon indicating that the build completed successfully.



If the build was terminated abnormally, a warning indicator will be displayed on the screen. See “Build Abort Errors” (page 214) for a list of abort related warnings/errors and resolution instructions.

Figure 23: Print Successful Dialog

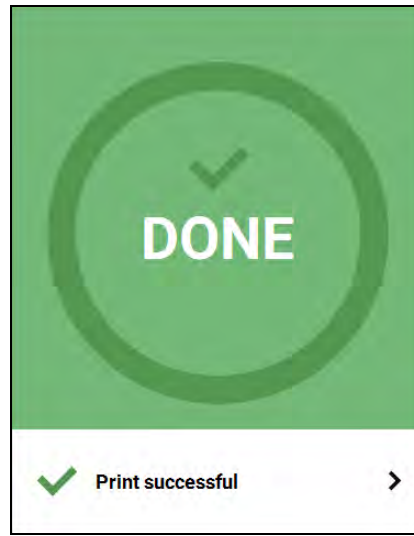

## Removing a Part from the Printer



### Warning: Hot Surface Hazard

Wear proper safety equipment when handling items inside the oven as surfaces within the oven can be very hot.

To remove a part from the printer:

1. Open the oven door.
2. Push down on the substrate ejection handle to release the substrate.



### Caution:

Do not attempt to remove a part from the substrate while the substrate is on the platen. Damage to the platen or platen level may occur.

3. Remove the substrate from the platen.
4. Carefully remove the part from the substrate.

# Changing Printer Defaults

Several factory presets can be changed via the options within the Tools page. To access this page, press the **Tools** button within the Navigation Menu.

The options within the Tools page are organized into 6 categories: Settings, Calibration, Maintenance, Network, Power, and Light. The defaults specified within the following instructions are accessible via the Settings page. To open this page press the **Settings** button within the Tools page.

After making the necessary adjustments to a default setting, press the **Back** button in the upper-left corner of the page to exit and return to the main Settings page.

## Job Storage

The Keep Previous Job setting determines whether or not the printer's previous job is stored within the Job Queue once a build is complete (see "Wait for Part" (page 72)). If you're concerned about other users of your printer seeing what you've built, this setting will prevent the printer's previous job from being accessible after the build is complete. By default this setting is set to On, meaning that the printer's previous job file is stored within the Job Queue making it available for re-selection upon completion of the build.

When this setting is set to Off, the printer's previous job file will be deleted from the Job Queue upon completion of the build. The job's file will need to be resent to the printer in order to be built again.

To configure this setting, press anywhere within the Keep Previous Job row; the Keep Previous Job page will be displayed. Use the radio buttons within this page to turn the setting On and Off as needed.

Figure 24: Keep Previous Job



## Part Build Location

The Part Placement setting determines whether or not you can select a job's placement on a substrate prior to starting the build (see "Part Placement" (page 74)).

To configure this setting, press anywhere within the Part Placement row; the Part Placement page will be displayed. Use the radio buttons within this page to turn the setting On and Off as needed.

Figure 25: Configure Part Placement



By default this setting is set to On, meaning you will be able to select a job's location on the substrate prior to starting the build (see "Selecting a Job to Build" (page 115)). At the start of a build the Part Placement dialog will be displayed asking you to select the part's build location (see Figure 26 (page 125)). The dialog will contain a graphic representing your printer's platen as well as a blue bounding box graphic (the imaginary box surrounding the part). You can select the part's build location by dragging and dropping the bounding box on the touchscreen; the bounding box cannot be placed outside the limits of the platen. Pressing the **Print** button will confirm your selected placement and start a build.

"Ghost box" graphics are also displayed; a "ghost box" represents the location where a part was built previously. Pressing the **Clear History** button will clear the display, removing all "ghost box" items.

When this setting is set to Off the Part Placement dialog will not be displayed prior to the start of a build. Single part jobs will be built in the center of a substrate while packs will be built according their selected placement within GrabCAD Print.

Figure 26: Part Placement Dialog

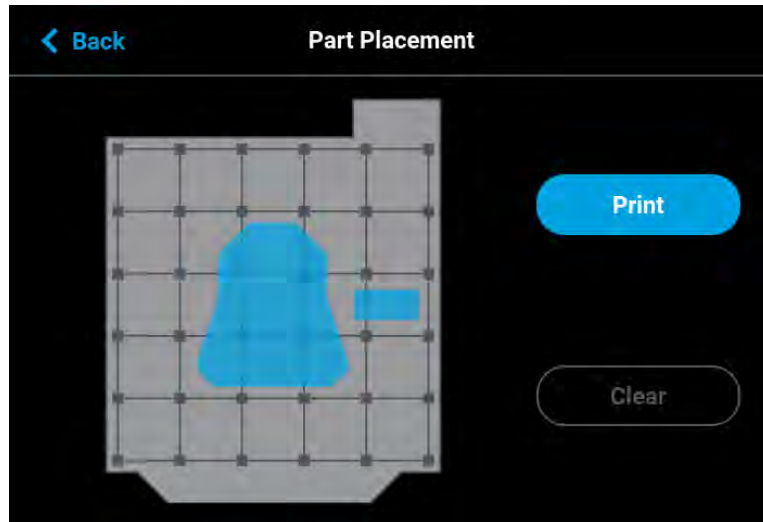

## Display Units

By default the UI is configured to display English units (inches). However, you can adjust this setting as needed to have the UI display metric units.

The Units setting determines the type of units that the printer is configured for, English or Metric. To configure this setting, press anywhere within the Units row; the Units page will be displayed. Use the radio buttons within this page to select between English and Metric units.

Figure 27: Configure Units

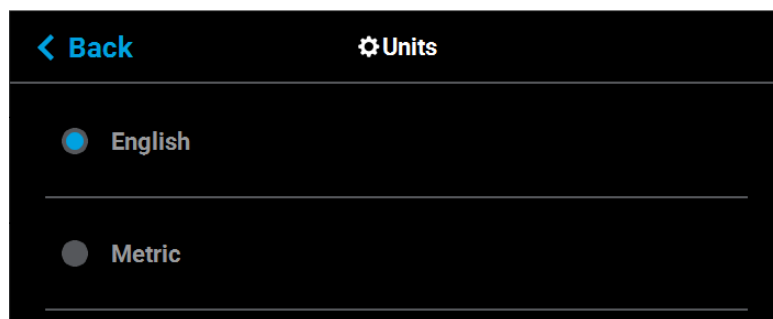

## Oven Temperature Control

Oven modeling temperature is determined by the material type (model and support) loaded within the printer. It is controlled by the printer's software and cannot be modified; however, you do have control of some oven temperature functions.

The Standby Mode setting gives the ability to put the printer into an energy saving state after the completion of a build (see "Standby Mode" (page 76)). When the Energy Saver option is selected (i.e. Standby Mode is turned On) the printer's oven will automatically shut off 2 hours after the completion of a build, thus saving energy. When the Quick Start radio button is selected (i.e. Standby Modes is turned Off) the printer's oven will remain On for 60 hours after the completion of a build and oven temperature will stay at the material's build temperature.

To configure this setting, press anywhere within the Standby Mode row; the Standby Mode page will be displayed. Use the radio buttons within this page to turn the Energy Saver option On and Off.

Figure 28: Configure Standby Mode

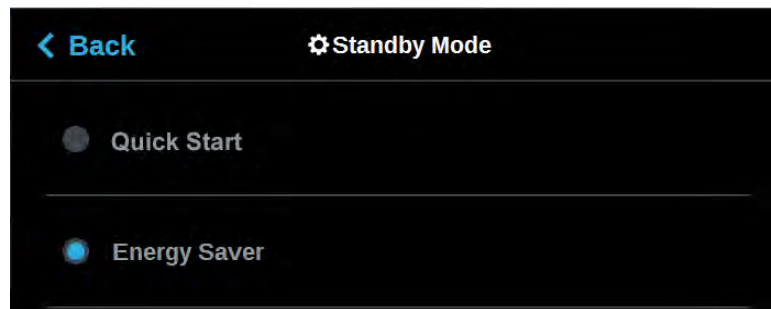

## Touchscreen Display Brightness

The Screen Brightness setting allows you to adjust the brightness of the touchscreen display (see "Screen Brightness" (page 78)). By default, the touchscreen display is configured to be at approximately 80% brightness.

To configure this setting, press anywhere within the Screen Brightness row; the Screen Brightness page will be displayed. Use the slider graphic to adjust brightness as needed; sliding to the right will increase brightness, while sliding to the left will dim brightness. Please note that you cannot set screen brightness to 0% (completely dim). After exiting the Screen Brightness page the configured brightness will be displayed as a percentage within the Screen Brightness row.

Figure 29: Adjust Screen Brightness

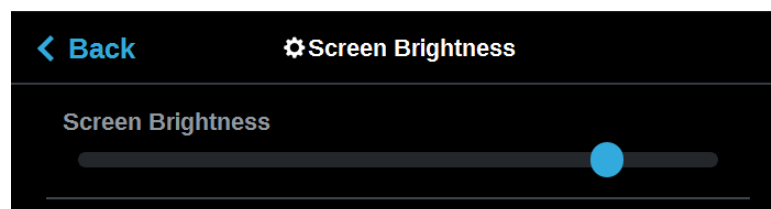

## Display Language

By default the text within the UI is displayed in English. However, you can adjust this setting as needed to have the UI exhibit a different language. In addition to English the display language can be set to Spanish, French, German, Italian, Russian, Chinese, and Japanese.

The Language setting determines the language that the UI is configured for. To configure this setting, press anywhere within the Language row; the Language page will be displayed. Use the scrollbar (along the right side of the page) to view the list of available languages. Select the radio button corresponding to your desired language.

Figure 30: Configure Language

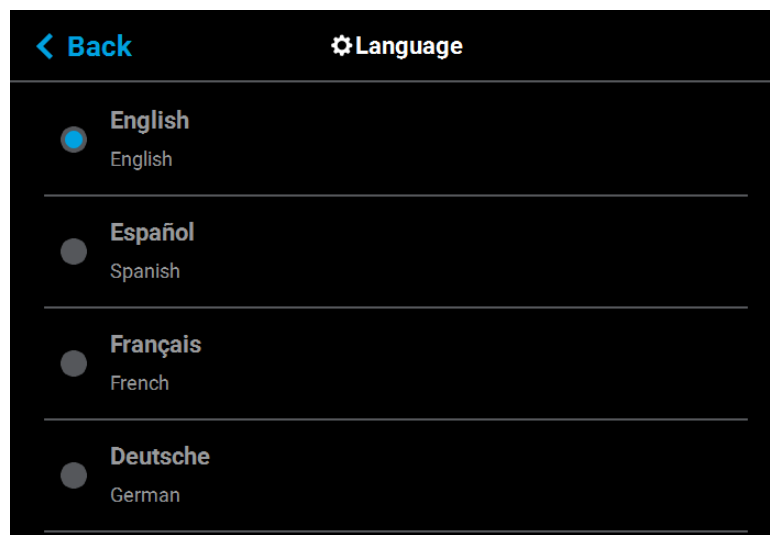

## Printer Status

The various pages of the User Interface display each of the following:

- Head odometer status
- Material status
- Temperature status
- Controller Software version
- Other printer information

## Head Odometer Status

The printer tracks and displays the total amount of material extruded through a head since it was last replaced. Head odometer values can be determined via the head's Head Details page. To locate this information press the **Materials** button within the Navigation Menu, the Materials page will be displayed. Two "Head Status Icons" (page 54), one corresponding to the model head and the other corresponding to the support head, are displayed within the upper



portion of the Display Area of the page. Touching one of these icons on the screen will open that head's Head Details page (see [“Viewing Head Details” \(page 56\)](#)). Odometer information for the selected head is displayed within the right half of the Head Details page (see [Figure 26 \(page 57\)](#)).

The Head Status Icons can become yellow or red based on the head's odometer (see [Table 6 \(page 54\)](#)). An accompanying warning/error notification will be displayed within the Materials page when a head is in a warning or error state resulting from odometer related information (see [“Head Warnings” \(page 216\)](#) and [“Head Errors” \(page 216\)](#)). An icon with yellow coloring indicates a warning, reminding you that the head is reaching its odometer limit. An icon with red coloring indicates an error, reminding you that the head has exceeded its odometer limit. You can continue using a head which has exceeded its odometer limit, but it is highly recommended that you change the head as part quality will be unpredictable. Warning and error states will be indicated on the User Interface until the head is replaced, and you will be required to acknowledge the notification associated with these states prior to the start of each build.

## Materials Status

The current status of each of the material coil boxes connected to the printer can be viewed via the Materials page. To locate this information:

1. Press the **Materials** button within the Navigation Menu; the Materials page will be displayed.
2. The Display Area of this page contains two [“Material Status Icons” \(page 59\)](#). The left icon pertains to the printer's model material while the right icon pertains to the printer's support material. The number displayed within the top of the icon indicates which material slot the material coil box is connected to (1 or 2). The colored bars (displayed within the center of the icon) and percentage (displayed at the bottom the icon) indicate the current volume of material in the box. The name of the type of material in the box is displayed at the bottom of the icon.

3. Touching one of these icons on the screen will open that material's Material Details page (see "Viewing Material Details" (page 61)).

Figure 31: Materials Status Locations

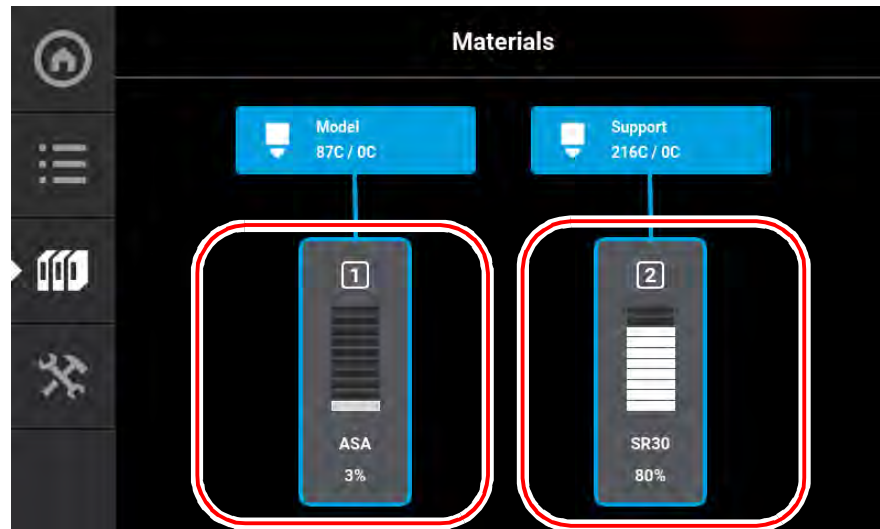

Icons and filament pathways will take on a variety of colors and highlighted states, depending on their status (see Table 7 (page 60) for detailed status explanations). Coloring pertains to both model and support Material Status Icons:

- Blue border - indicates that a valid material coil box is connected to the corresponding material slot, the blue filament pathway indicates that material from the box is loaded to the head and is selected to be used for building.
- Gray (dashed border) - an icon that is blank in the center with a gray dashed border and gray dashed filament pathway indicates that a material coil box is not connected to the printer.
- Yellow - an icon with yellow coloring indicates an issue/warning (see "Warnings and Errors" (page 205) for more information).
  - A volume of 0% accompanied by solid yellow coloring indicates an empty material coil box.
- Red - an icon with red coloring indicates an error (see "Warnings and Errors" (page 205) for more information).
  - A red border with a notification badge in the center of the icon indicates that the material coil box is invalid (i.e. not licensed or not compatible with the associated head type).
  - A red border with a notification badge within the center of the filament pathway indicates a load related error.
  - A semi-solid red icon indicates that an error occurred when checking the data on the material coil box's memory chip and the box is unusable.
  - A solid red icon indicates that communication with the material coil box is not possible.

# Temperature Status

## Oven Temperature

The oven's temperature can be viewed via the Maintenance page. To locate this information:

1. Press the **Tools** button within the Navigation Menu; the Tools page will be displayed.
2. Press the **Maintenance** button within the Tools page; the Maintenance page will be displayed.
3. Locate the Chamber row within the page. The printer's current and set point oven chamber temperatures are displayed within this row.

Figure 32: Maintenance Page Oven Chamber Temperature



## Head Temperature

To view temperature information pertaining to the model and support heads within the Materials page:

1. Press the **Materials** button within the Navigation Menu; the Materials page will be displayed.
2. The Display Area of this page contains two Head Status Icons, one corresponding to the model head and the other corresponding to the support head. (See "[Head Status Icons](#)" (page 54) for details). The head's current temperature as compared to its set point temperature is displayed within the lower portion of the icon.

3. Touching one of these icons on the screen will open that head's Head Details page. The same temperature information is displayed within this page for both the model and support heads.

Figure 33: Materials Page Head Temperatures

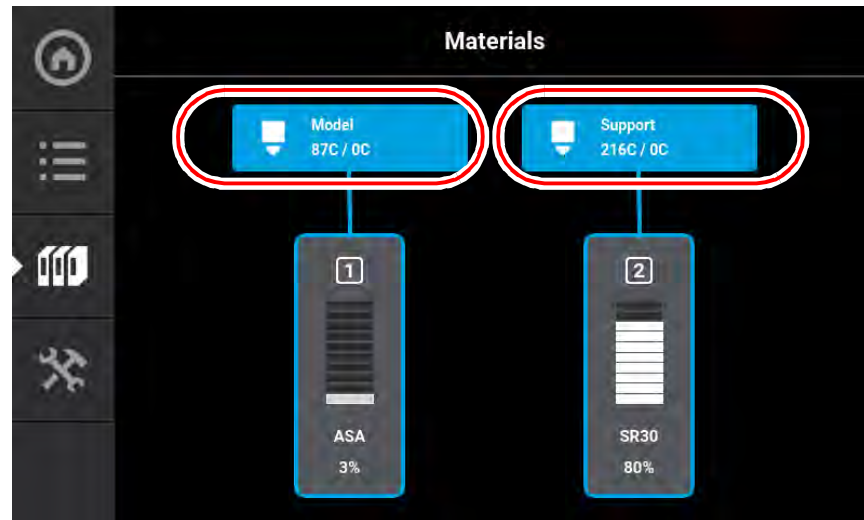

## Software Version

Version information for the software used to control the printer (Controller Software) can be accessed via the Maintenance page:



Controller Software is installed on a flash device located on the Controller board and should not be confused with GrabCAD Print software, which is installed on the workstation PC.

1. To access the Maintenance page, press the **Maintenance** button within the Tools page (see "Working with the Tools Page" (page 69)).
2. Locate the Update Software row within the page (see "Maintenance" (page 86)).
3. The printer's Controller Software version information is displayed within the Update Software row.

Figure 34: Controller Software Version Information



## MTConnect System Activation

Activating the MTConnect system enables the MTConnect data exchange protocol between the printer and an MTConnect client for the purpose of tracking printer defined metrics. MTConnect is available for all F123 Series systems and requires firmware Version 3.27.3214 or later.



Firmware version 3.31.3614 (or later) is recommended for all systems.

MTConnect must be enabled on the printer. To do this from the Home Screen:

1. Select the Tools screen.

Figure 35: Home Screen

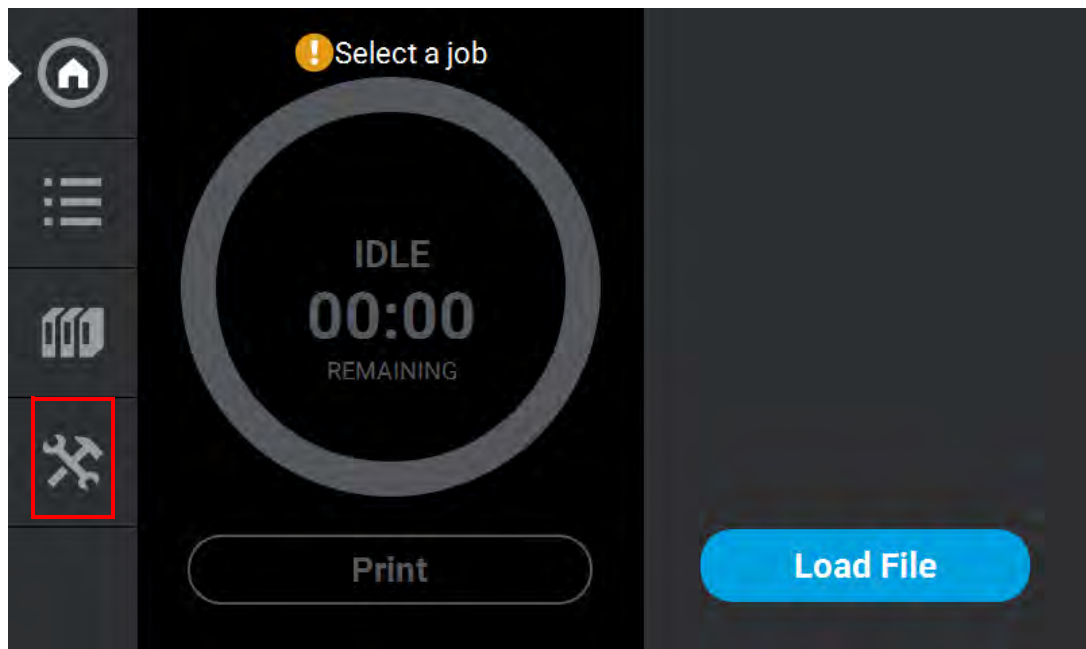

- From the Tools screen, select the Settings screen.

Figure 36: Access Setting screen

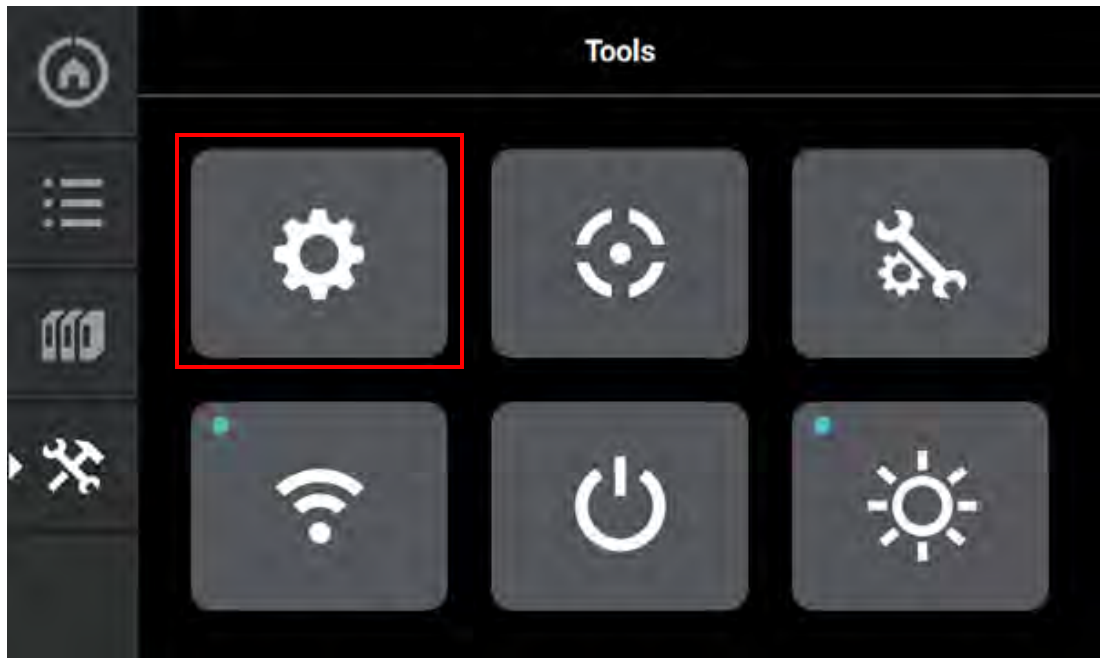

- On the Settings screen, scroll down to the MTConnect setting. Select MTConnect.

Figure 37: MTConnect

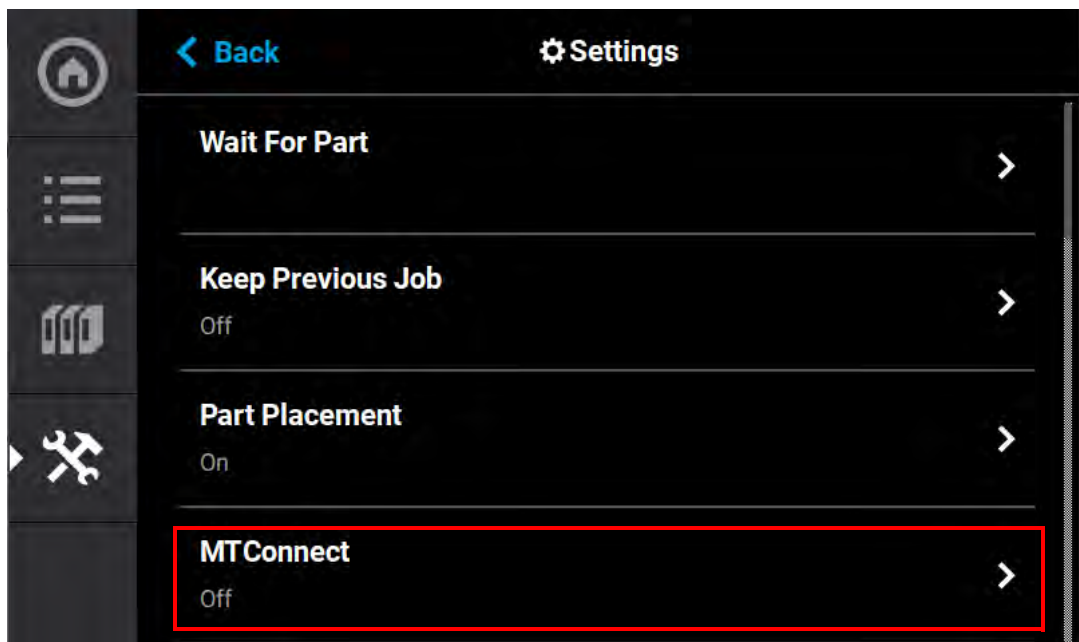

4. On the MTConnect screen, touch the On button to turn MTConnect ON.

Figure 38: Turn ON MTConnect

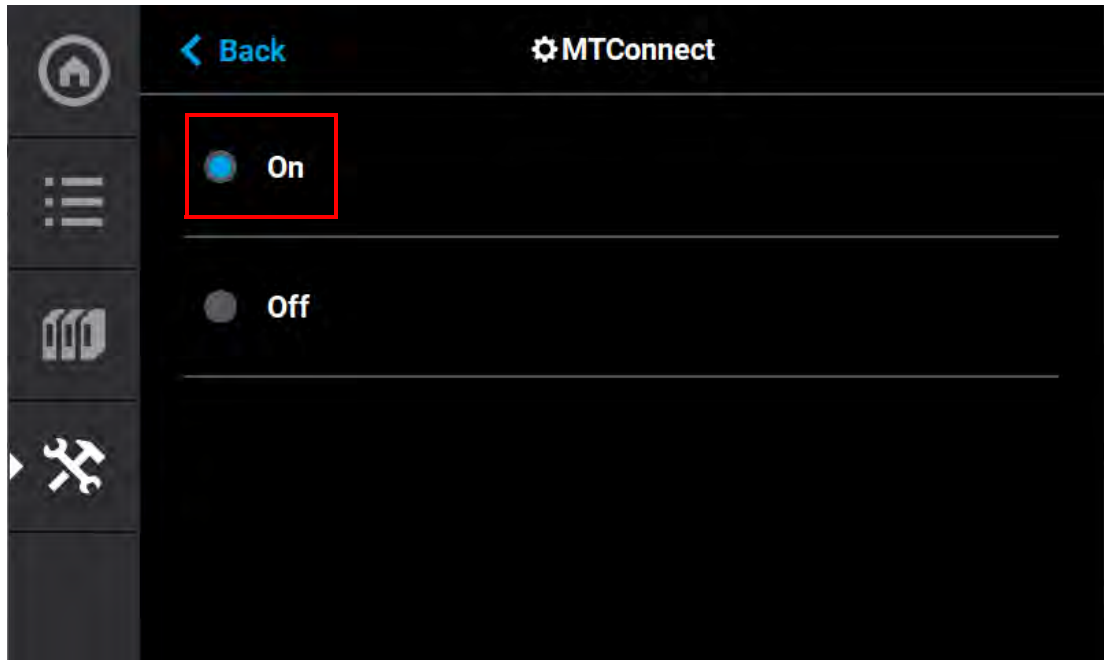

5. If the printer is connected to a network, you can view the device information and current MTConnect data by using a web browser as a client and the system's IP address. The IP address can be obtained via the Network Window.

Figure 39: Network Information

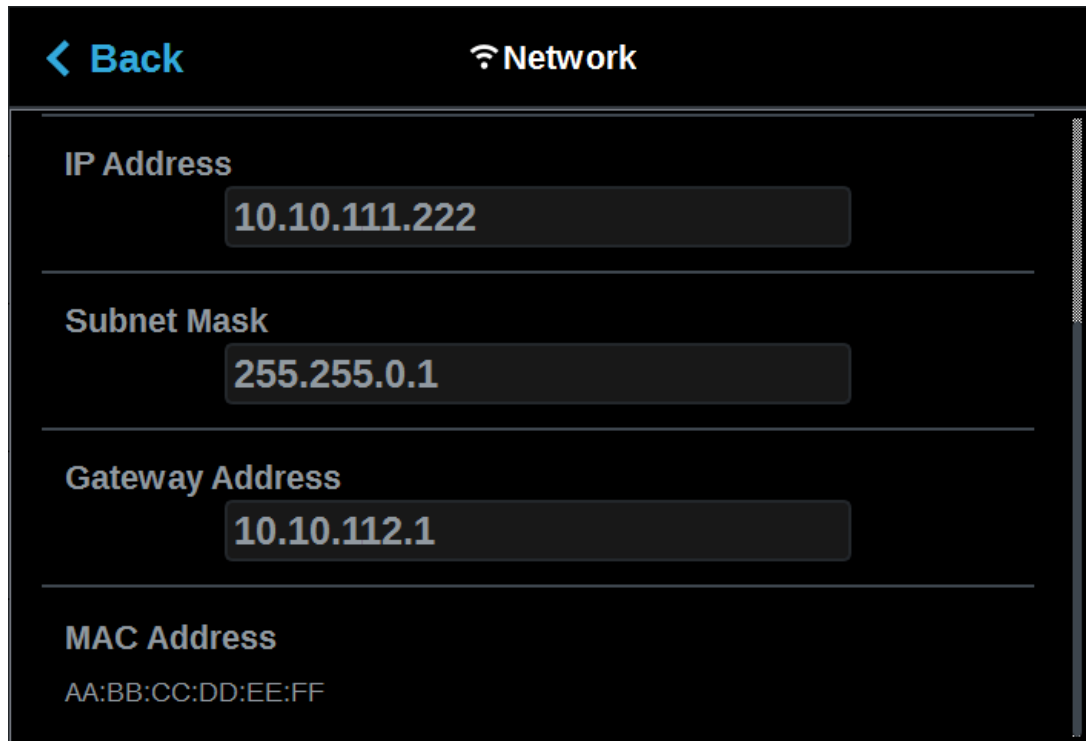

6. To verify the system is on the network, open a web browser and type `http://xxx.xxx.xxx.xxx:5000/probe` replacing the "xxx.xxx.xxx.xxx" with the obtained IP address. The device information is returned.





The IP address need not be in 3 digit segments. Do not use leading zeros. For Example: IP Address = 10.40.202.149, use http://10.40.202.149:5000/probe, NOT http://010.040.202.149:5000/probe

Figure 40: Computer Information

```
10.10.114.172:5000/probe
Not secure | 10.10.114.172:5000/probe
This XML file does not appear to have any style information associated with it. The document tree is shown below:
<?xml version="1.0" encoding="UTF-8" standalone="no" ?>
<MTConnectDevices xmlns="urn:mtconnect.org:MTConnectDevices:1.3" xmlns:xsi="http://www.w3.org/2001/XMLSchema-instance"
  xsi:schemaLocation="urn:mtconnect.org:MTConnectDevices:1.3 http://www.mtconnect.org/schemas/MTConnectDevices_1.3.xsd"
  creator="creationTime="2019-01-07T13:28:00Z" sender="900mc_900T" instanceId="1549191644" version="1.3.0.17" assetBufferSize="1024" assetCount="0" bufferSize="131072"/>
  <Devices>
    <Device id="dev" name="Fortus_900mc" sampleInterval="10" uuid="1ff69003">
      <Description manufacturer="Stratasys" serialNumber="9003"Fortus_900mc/Description>
      <DataItem category="EVENT" id="avail" name="Availability" type="AVAILABILITY"/>
      <DataItem category="EVENT" id="dev_asset_chg" type="ASSET_CHANGED"/>
      <DataItem category="EVENT" id="dev_asset_rem" type="ASSET_REMOVED"/>
    </DataItem>
    <Components>
      <LightTower id="LightTower" name="LightTower">
        <DataItem category="EVENT" id="lightTowerState" type="LIGHTTOWERSTATE"/>
      </LightTower>
      <Axes id="Axes" name="Axes">
        <Components>
          <Extruder id="e1" name="Model">
            <DataItem category="SAMPLE" id="e1fact" name="ActualTemperature" nativeUnits="CELSIUS" subtype="ACTUAL" type="TEMPERATURE" units="CELSIUS"/>
            <DataItem category="SAMPLE" id="e1com" name="CommandedTemperature" nativeUnits="CELSIUS" subtype="COMMANDED" type="TEMPERATURE" units="CELSIUS"/>
            <DataItem category="SAMPLE" id="e1dCycle" name="DutyCycle" nativeUnits="PERCENT" subtype="ACTUAL" type="DUTY_CYCLE" units="PERCENT"/>
            <DataItem category="EVENT" id="e1Material" name="CurrentMaterial" type="MATERIAL"/>
            <DataItem category="EVENT" id="e1MaterialId" name="CurrentMaterialId" subtype="MATERIAL_ID" type="ID"/>
            <DataItem category="EVENT" id="e1Tip" name="Tip" type="TIP"/>
            <DataItem category="SAMPLE" id="e1tipOdometer" name="Odometer" nativeUnits="CENTIMETER" type="ODOMETER" units="CENTIMETER"/>
            <DataItem category="SAMPLE" id="e1tipFollow" name="FollowingError" nativeUnits="MILLIMETER" subtype="ACTUAL" type="FOLLOWING_ERROR" units="MILLIMETER"/>
          </Extruder>
          <Extruder id="e2" name="Support">
            <DataItem category="SAMPLE" id="e2fact" name="ActualTemperature" nativeUnits="CELSIUS" subtype="ACTUAL" type="TEMPERATURE" units="CELSIUS"/>
            <DataItem category="SAMPLE" id="e2com" name="CommandedTemperature" nativeUnits="CELSIUS" subtype="COMMANDED" type="TEMPERATURE" units="CELSIUS"/>
            <DataItem category="SAMPLE" id="e2dCycle" name="DutyCycle" nativeUnits="PERCENT" subtype="ACTUAL" type="DUTY_CYCLE" units="PERCENT"/>
            <DataItem category="EVENT" id="e2Material" name="CurrentMaterial" type="MATERIAL"/>
            <DataItem category="EVENT" id="e2MaterialId" name="CurrentMaterialId" subtype="MATERIAL_ID" type="ID"/>
            <DataItem category="EVENT" id="e2Tip" name="Tip" type="TIP"/>
            <DataItem category="SAMPLE" id="e2tipOdometer" name="Odometer" nativeUnits="CENTIMETER" type="ODOMETER" units="CENTIMETER"/>
            <DataItem category="SAMPLE" id="e2tipFollow" name="FollowingError" nativeUnits="MILLIMETER" subtype="ACTUAL" type="FOLLOWING_ERROR" units="MILLIMETER"/>
          </Extruder>
        </Components>
      </Axes>
    </Components>
  </Device>
</Devices>
```

- Change “probe” to “current” (<http://xxx.xxx.xxx.xxx:5000/current>) will return the current MTConnect data for the system.

Figure 41: MTConnect Data

- creationTime: 2020-11-19T17:05:05Z
- sender: f370D30639
- instanceId: 1605299318
- version: 1.4.0.12
- bufferSize: 131072
- nextSequence: 7415699
- firstSequence: 7284627
- lastSequence: 7415698

---

**Device: f370; UUID: D30639**

**Feeder : ModelBay1**

Samples

Timestamp	Type	Sub Type	Name	Id	Sequence	Value
2020-11-13T20:28:13.974563Z	VolumeSpatial		CurrentVolume	mb1CurrentVolume	157	865073.0611
2020-11-13T20:28:13.974563Z	CapacitySpatial		InitialVolume	mb1InitialVolume	156	1474835.76

Events

Timestamp	Type	Sub Type	Name	Id	Sequence	Value
2020-11-13T20:28:13.974563Z	EquipmentMode		LoadState	mb1LoadState	164	OFF
2020-11-13T20:28:13.974563Z	Material		MaterialName	mb1Mat	158	ASAD_BLK
2020-11-13T20:28:13.974563Z	PartId		MaterialId	mb1MatId	159	842
2020-11-13T20:28:13.974563Z	PartId		ManufacturingDate	mb1MfgDate	160	WED DEC 4 01:21:53 2019
2020-11-13T20:28:13.974563Z	PartId		ManufacturingLot	mb1MfgLot	168	108739
2020-11-13T20:28:13.974563Z	SerialNumber		SerialNumber	mb1SerialNumber	163	520314272

**Feeder : ModelBay2**

- You can still view the device information and current MTConnect data by using a web browser as a client and the system’s IP address even if the printer is not on a network. You can do this by directly connecting a computer to the printer with a Crossover Cable connected to the Ethernet Ports. Ensure the Static radio button is selected on the Network Mode window.

Figure 42: Static Network

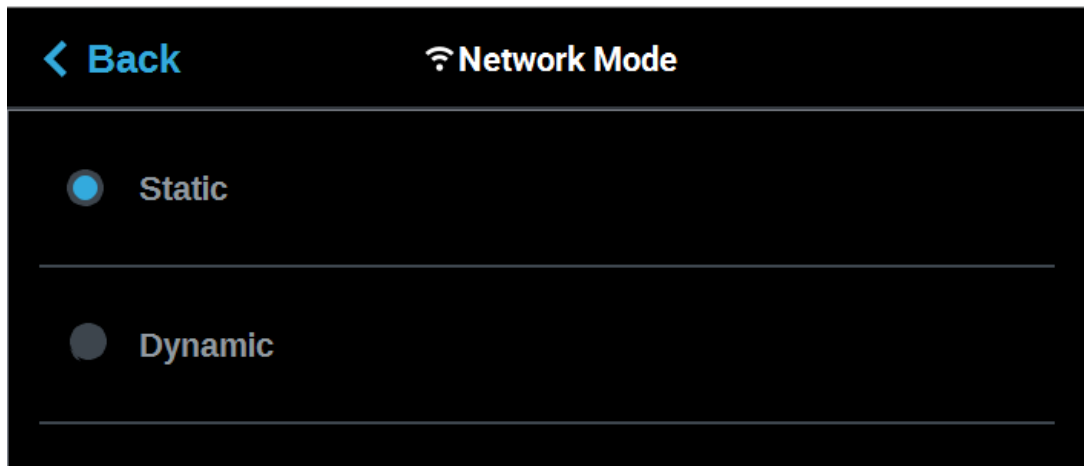

9. Connect a computer to the printer at the ethernet ports using a crossover cable.
10. Navigate to the computer's Ethernet Network Settings and select "Change Adapter Options".
11. Right click on Ethernet and select Properties.

Figure 43: Locate Ethernet Settings

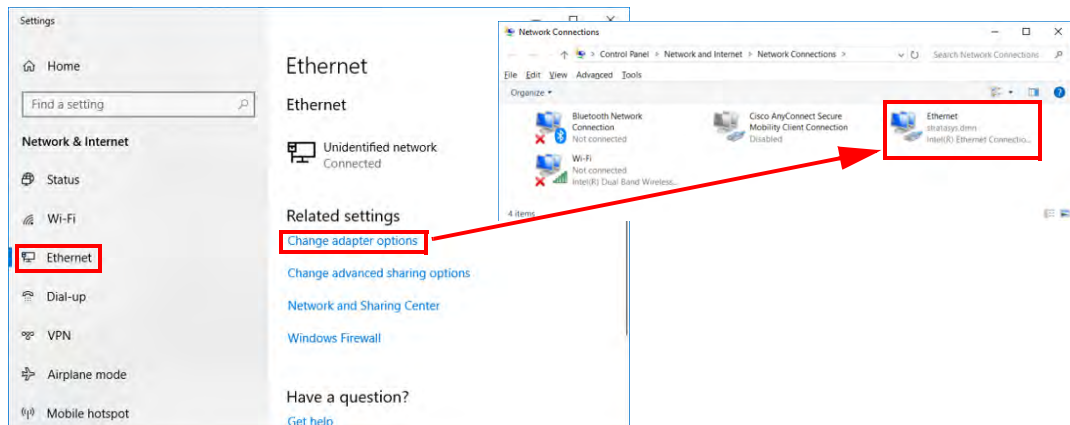

12. In the Ethernet Properties screen, using the images below as a general guide, set the "IP address" to match the printer's, EXCEPT change the last triplet to another number between 1 and 255.
13. Set the "Subnet mask" to match the printer and click OK.

- 14. The computer and your printer can now communicate like an “isolated” network. The previously explained method of using a browser as a client will work.

Figure 44: Ethernet Properties

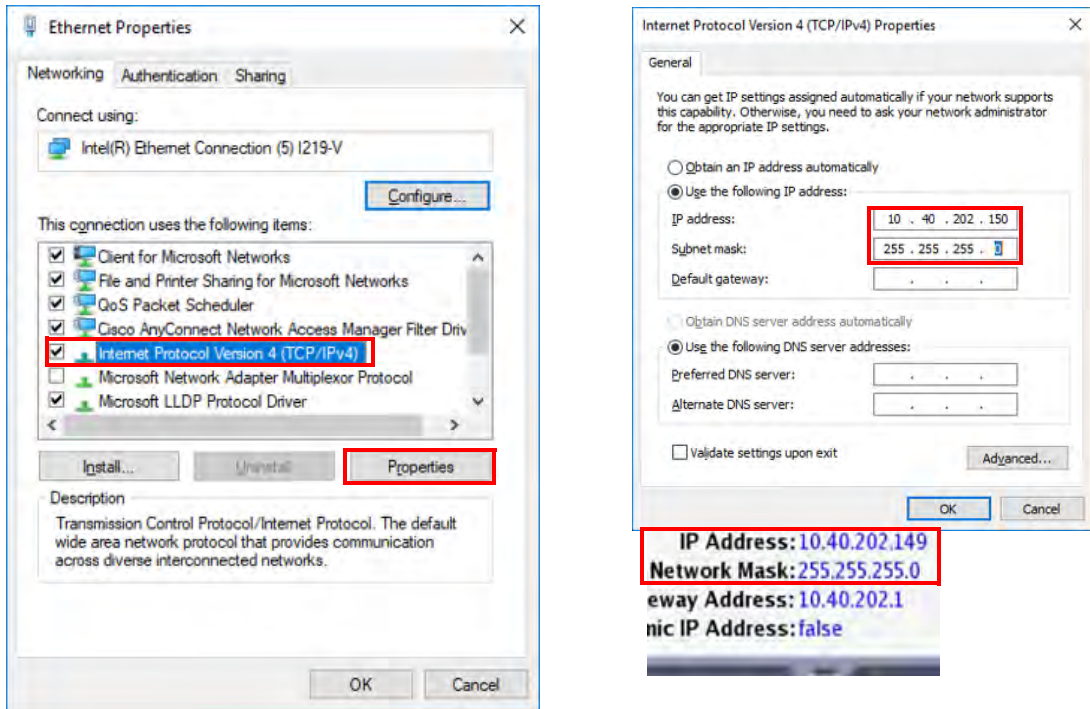

# 6 CALIBRATION AND ADJUSTMENTS

This chapter describes basic calibration and adjustment procedures for the F120. The buttons/pages described within this chapter are accessible via the *Calibration* page.

To open the Calibration page, press the **Tools** button within the *Navigation* Menu; the *Tools* page will be displayed (see “Working with the Tools Page” (page 69)). Within the *Tools* page select the **Calibration** button; the *Calibration* page will be displayed.

Figure 1: *Calibration* page

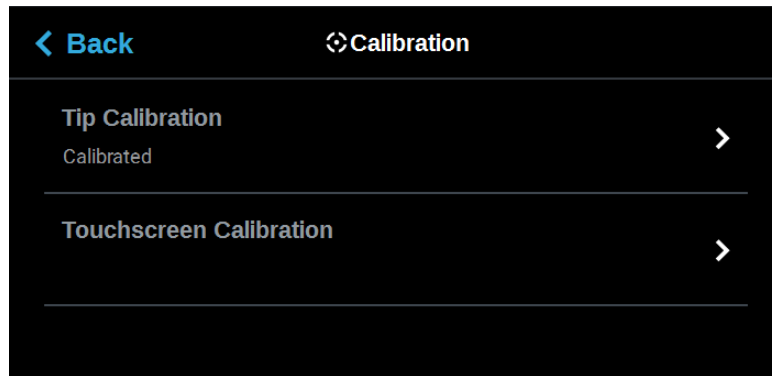

## Tip Calibration

The printer’s calibration status will be displayed within the *Tip Calibration* row. **Calibrated** or **Not Calibrated** will be displayed depending on the printer’s calibration status.

Pressing anywhere within the *Tip Calibration* row will open a page allowing you to select from a variety of tip calibration options. You cannot build parts on the printer until the printer’s tips are calibrated.

Figure 2: *Tip Calibration*

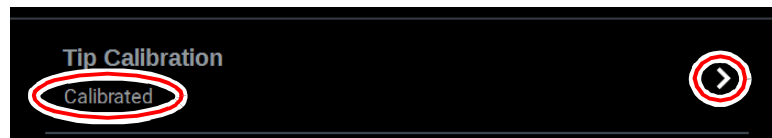

The *Tip Calibration* page contains an option for performing an Automatic Tip Calibration as well as a Manual Tip Calibration. Pressing the **Start** button associated with either of these options will allow you to perform that particular calibration procedure. Each calibration procedure is delivered in the form of a wizard which will guide you through the process of performing the calibration procedure.

Figure 3: Tip Calibration Options

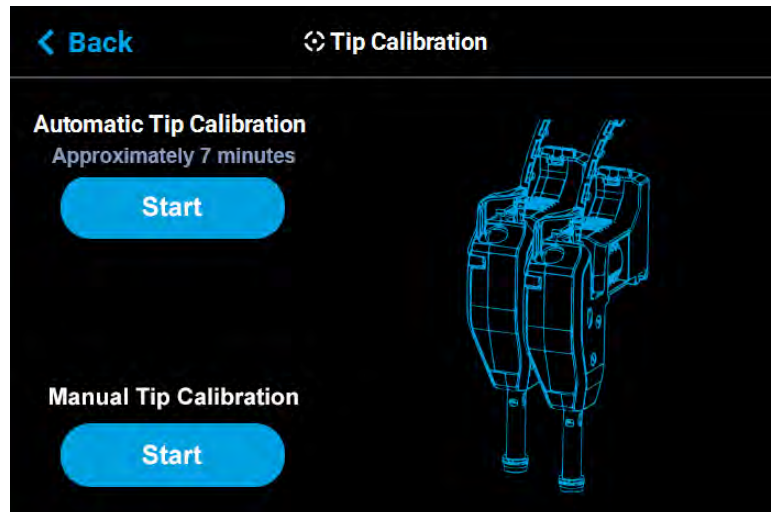

## Automatic Tip Calibration

Tip offset values are the distance between the model and support tips in the X, Y and Z directions. Accurate tip offset values ensure that support toolpaths are accurately located in reference to model toolpaths. Inaccurate tip offset values can cause part quality issues, such as support material embedded in a part or improperly supported parts.

Automatic Tip Calibration registers the support tip relative to the model tip, ensuring that positioning of the head and Z axis is correct when changing between model and support material during a build. This calibration is automatically performed whenever either of the printer's heads is replaced; please note that the printer must be powered ON before calibration can occur. Calibration will occur prior to the start of the next build following the head replacement. If either head cable is unclipped and fully detached from the corresponding head, this will trigger the occurrence of an Automatic Tip Calibration. Calibration will occur following the reattachment of the cable to the head and prior to the start of the next build.



For best results when printing and maximum head life expectancy, a manual tip calibration must be performed after an automatic tip calibration.

To Perform an Automatic Tip Calibration:

1. Place a new substrate onto the platen and lock the substrate into its build position by lifting up on the substrate ejection handle.



**Caution:**

Always wear gloves when installing the substrate. Hand oils on the substrate surface will result in poor part adhesion.

2. Open the Tip Calibration page by navigating to *Tools > Calibration > Tip Calibration*. A page similar to Figure 4 will be displayed.
3. Press the **Start** button for the Automatic Tip Calibration option.

Figure 4: Automatic Tip Calibration Option

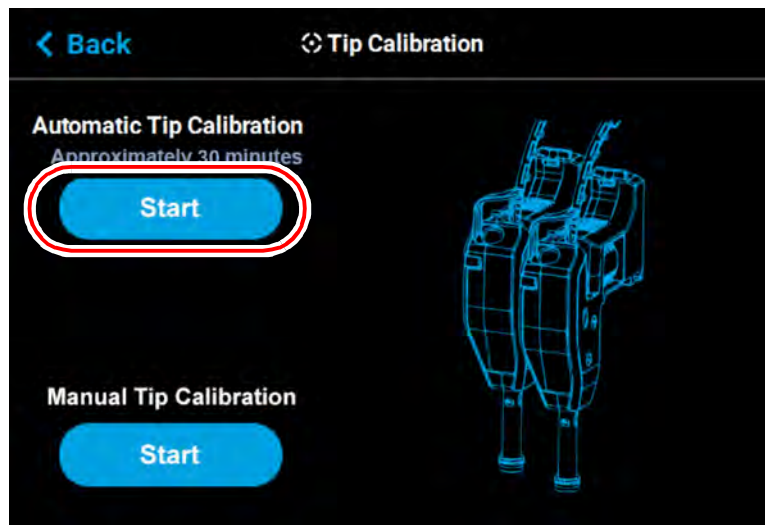

- The printer will perform an Automatic Tip Calibration. This process includes heating up or cooling down the oven to reach the required calibration temperature. Completion times will vary depending on the material used and the initial chamber temperature. The status and time remaining will continually update on the screen.

Figure 5: Calibrating Tip Offsets

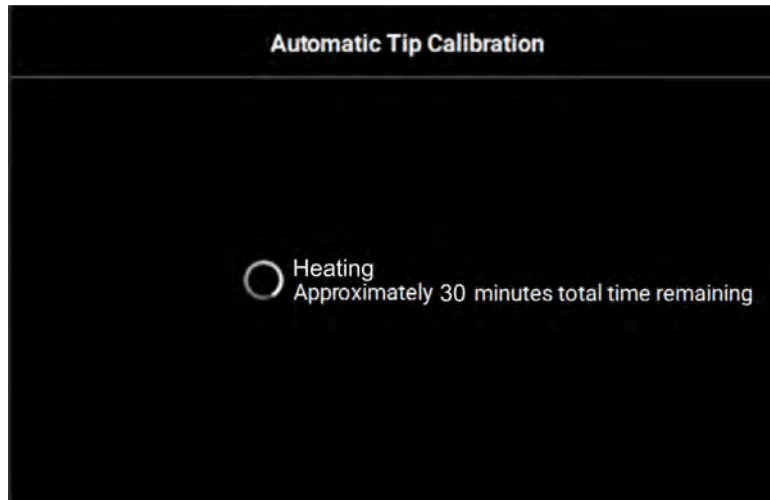

- Completion of the calibration process will be indicated on the screen; press the **Finish** button within the header of the page when complete.

 If calibration fails, "Failed to calibrate tip offsets" will be displayed on the screen. You cannot build a part on the printer until the tips have been calibrated. Ensure that nothing is blocking the tip or covering the calibration targets and reattempt the Automatic Tip Calibration. If calibration fails again, perform a Manual Tip Calibration (see "Manual Tip Calibration" (page 144) for instructions).

Figure 6: Automatic Tip Calibration Complete



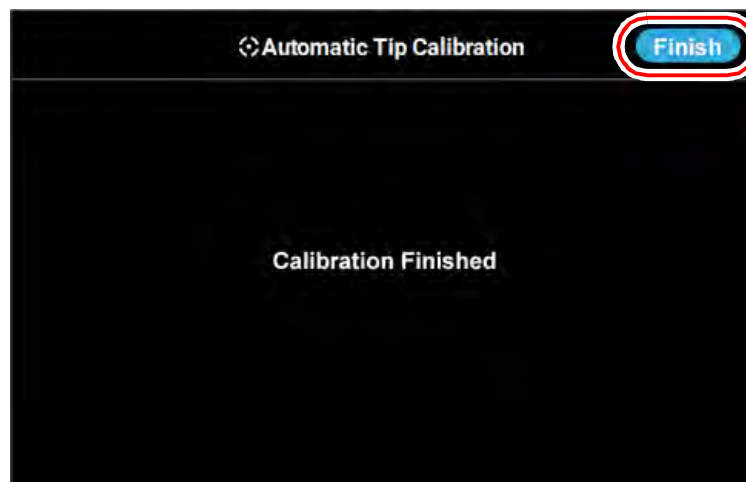

6. The main Tip Calibration page will display again. Proceed with the Manual Tip Calibration as described in “Manual Tip Calibration” (page 144).

Figure 7: Automatic Tip Calibration Option

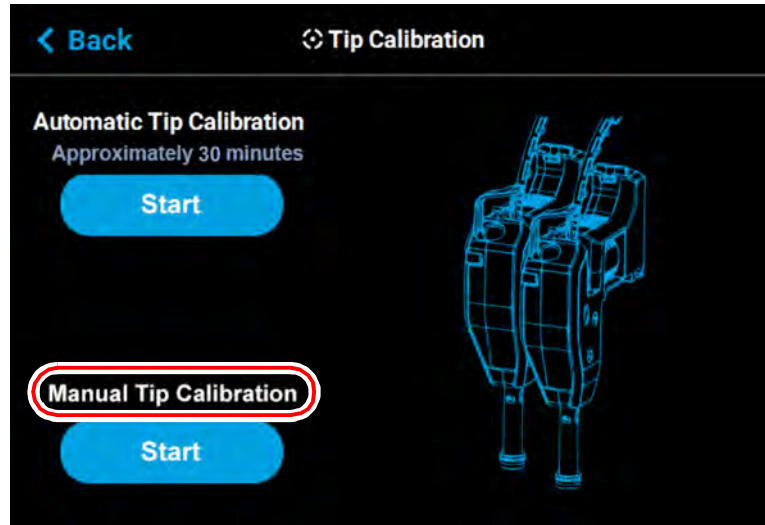

## Manual Tip Calibration

Tip offset values are the distance between the model and support tips in the X, Y and Z directions. Accurate tip offset values ensure that support toolpaths are accurately located in reference to model toolpaths. Inaccurate tip offset values can cause part quality issues, such as support material embedded in a part or improperly supported parts.

Manual Tip Calibration sets the X, Y and Z distance between the model and support tips. This calibration requires you to analyze a calibration part once it's built, and manually supply the printer with correction values, as needed, in order to calibrate the printer.

To Perform a Manual Tip Calibration:

1. Print a calibration part; you will analyze this part in order to determine correction values.
  - a. Place a new substrate onto the platen and lock the substrate into its build position by lifting up on the substrate ejection handle.



**Caution:**

Always wear gloves when installing the substrate. Hand oils on the substrate surface will result in poor part adhesion.

- b. Navigate to *Tools > Calibration > Tip Calibration*. Press the **Start** button for the Manual Tip Calibration option (see Figure 3 (page 141) for button location).

- c. The Print Calibration Part page will be displayed (as shown in Figure 8) and the printer will automatically select the calibration part. Press the **Start** button.

Figure 8: Print Calibration Part Page

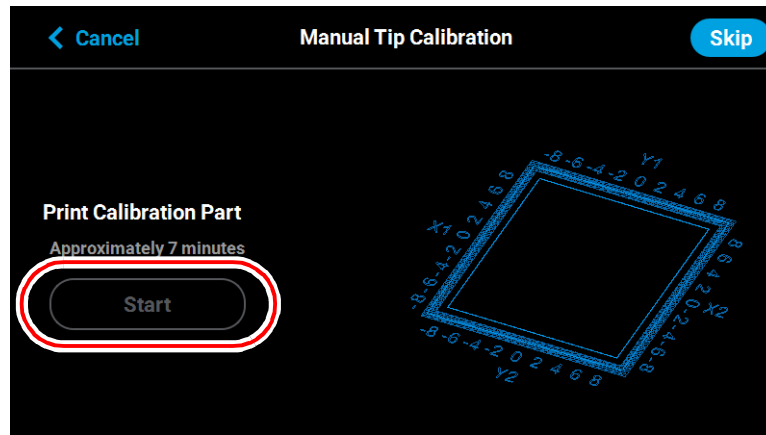

- d. If your printer's part placement setting is On (see "Part Placement" (page 74)), the Part Placement page will display. The calibration part location is fixed and can not be moved. Press the **Print** button (pressing the **Clear** button will clear the display, removing all "ghost box" items).
- e. The calibration part will begin the print process and display the current status on the User Interface. "HEATING" or "COOLING" is followed by "PREPARING" and then "PRINTING".
- The Heating/Cooling status displays the current temperature as well as the target set point.



The amount of time that the printer remains in the Heating/Cooling stage may vary depending on the current oven chamber temperature.

- The Preparing status will display as the system purges material and detects the tray level.
  - The Printing status displays the number of build layers complete or the amount of time remaining. Tap the screen to toggle between layers or time.
- f. Once the calibration part is complete "DONE" will be displayed on the User Interface. Remove the substrate from the platen. You will analyze the part on the substrate to determine correction values.



After removing the substrate containing the calibration part and closing the oven door, a message is displayed stating "Is the tray ready for another job?". Press **No** to return to the *Manual Tip Calibration* screen.

- g. Press the **Next** button in the upper-right corner of the page; the Manual Tip Calibration page will be displayed.

Figure 9: Manual Tip Calibration Page

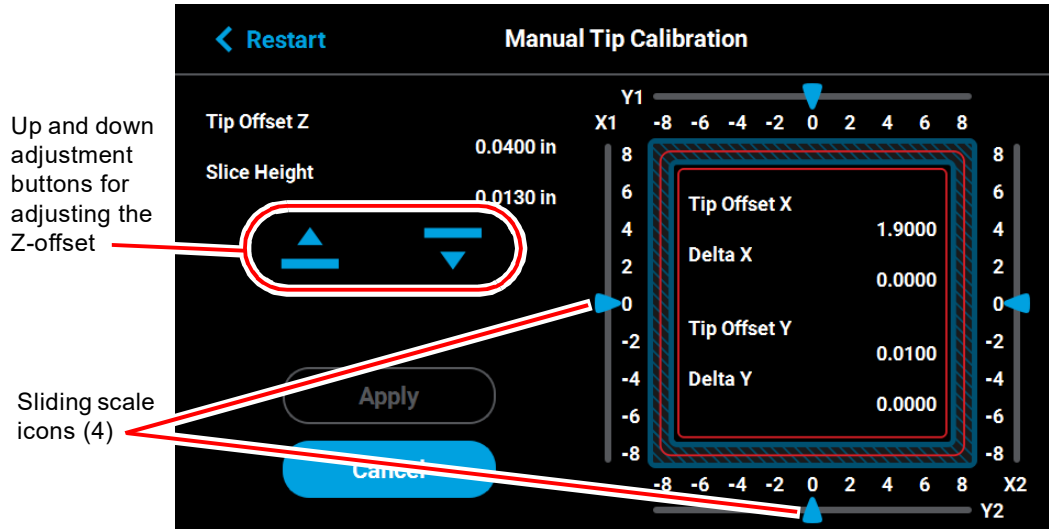

**i** The **Apply** button will become active when you modify an offset value by dragging the sliding scale icons or pressing the up and down adjustment buttons.

Figure 10: Apply button active

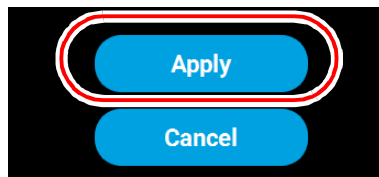

- 2. Determine the XY Offset Adjustment needed for your printer.
  - a. Using a magnifier (included in the Welcome Kit), view the relationship between the support calibration toolpath and the alignment indicators to determine the X and Y axis calibration.

- b. Determine where on each side (X1, X2, Y1, and Y2) the support toolpath is most centered between the X-Y alignment indicators (see Figure 11 or Figure 12). The numbers on the calibration part represent thousandths of an inch (e.g., 4 = 0.004 in.).

Figure 11: Calibration Part

Magnified single side of a calibration part with a reading of 0.

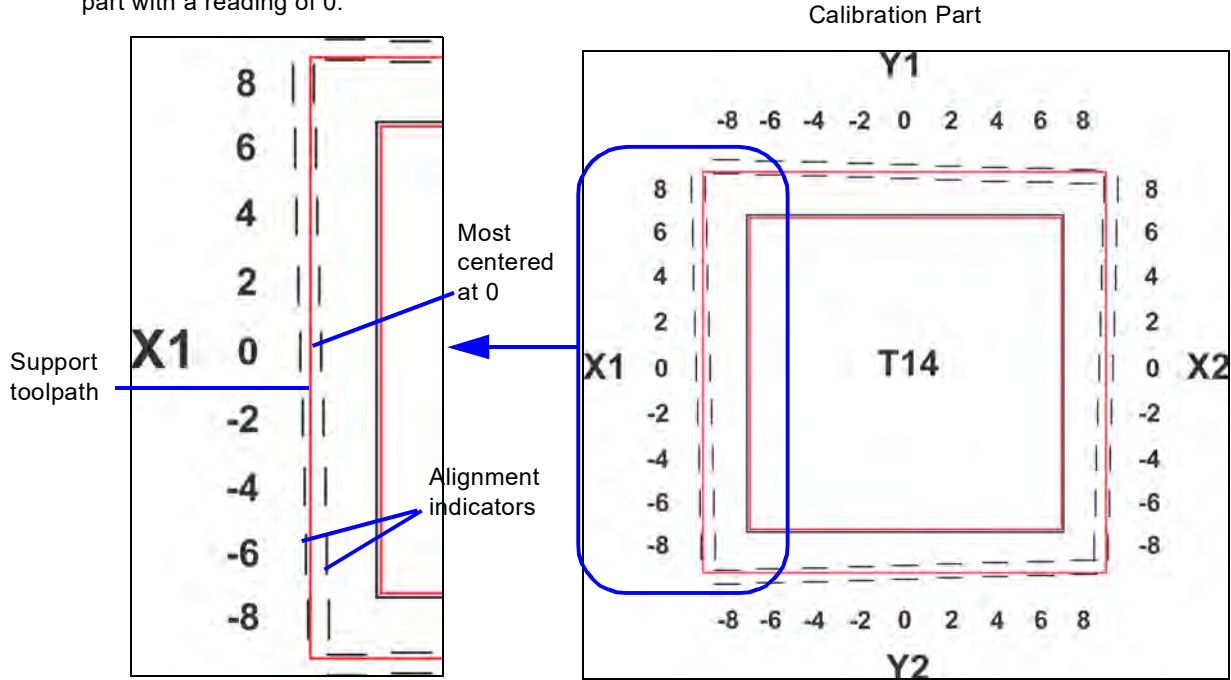
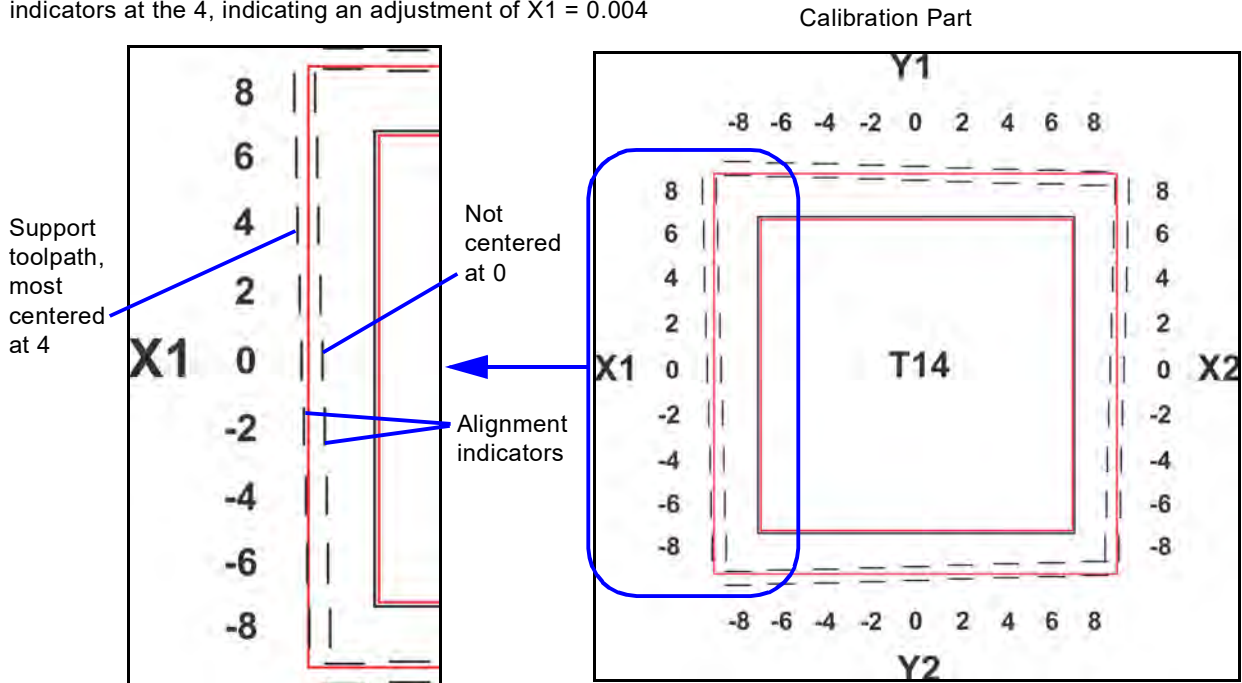

Figure 12: Calibration Part

Support toolpath is most centered between the alignment indicators at the 4, indicating an adjustment of  $X1 = 0.004$



- c. Within the Manual Tip Calibration page, slide all four of the scale icons on the screen to match where the support toolpath is most centered between the alignment indicators. The Delta X and Delta Y fields will change to reflect adjustments made.

**i** One offset value must be selected for each side (X1, X2, Y1, and Y2).

- If the Delta X and the Delta Y values are both within the range of -0.002 to +0.002 in., the printer is calibrated and an adjustment is not required. The following figure shows an XY offset within tolerance, requiring no adjustments. Proceed to step 3.

Figure 13: XY Offset - No Adjustment Required

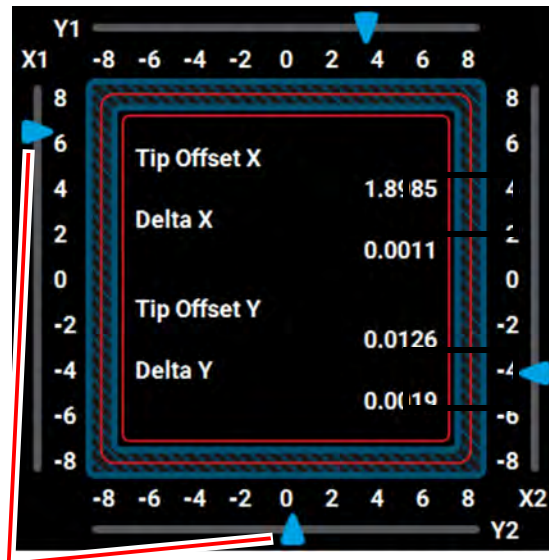

Sliding scale icons (4)

- If either of the Delta X or Delta Y values are outside the range of -0.002 to +0.002 in., the printer requires an adjustment. The following figure shows the Delta X value of 0.0050 in. and the Delta Y value of -0.0030 in. are both outside of the acceptable range.

Figure 14: XY Offset - Adjustment Required

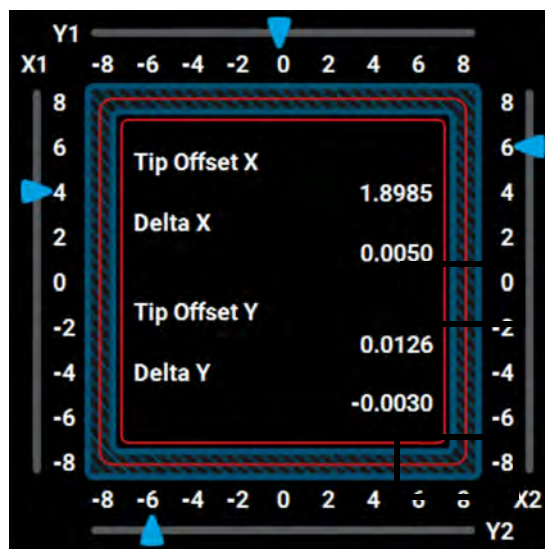

- d. If an adjustment is required, you will need to rebuild the calibration part. To do so:
- After entering your adjustment value(s) press the **Apply** button within the Manual Tip Calibration page (see [Figure 9 \(page 146\)](#) for button location). Your calibration adjustment(s) will be saved. If you continue to change the adjustment values, you must press the **Apply** button again to save the changes.



The *Cancel* button can be used to reset an adjustment value entered prior to pressing the **Apply** button. Once the **Apply** button is pressed, values will be saved and the printer's calibration settings will reflect the adjustment value entered. Use caution when entering an adjustment value to ensure it is correct prior to pressing the **Apply** button.

- After pressing the **Apply** button, the **Close** button will appear. Press the **Close** button to return to the initial Tip Calibration page.

Figure 15: Close Button Location

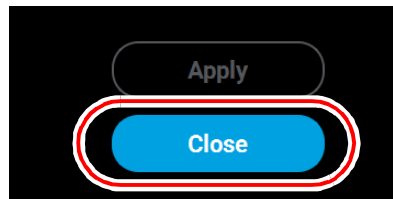

- Repeat [step 1](#) above to build a calibration part.
  - Repeat the instructions in [step 2](#). Continue to check and adjust for XY offset. Readjust until both of the Delta X and Delta Y values are within tolerance, which is within -0.002 to +0.002 in.
- e. Proceed to the Z offset adjustment ([step 3](#) below) once the calibration toolpath for X and Y is within tolerance.
3. Determine the Z Offset Adjustment.
- Peel the support layer from the inner square of the calibration part.
  - Measure the thickness of the support layer on each side of the square with a caliper or micrometer. Measure in the center of each side; measuring near the corners will result in inaccurate values.

- c. Take the average value of the four measurements. This is the number you will enter for the Z offset adjustment.

Figure 16: Remove and Measure Support Layer

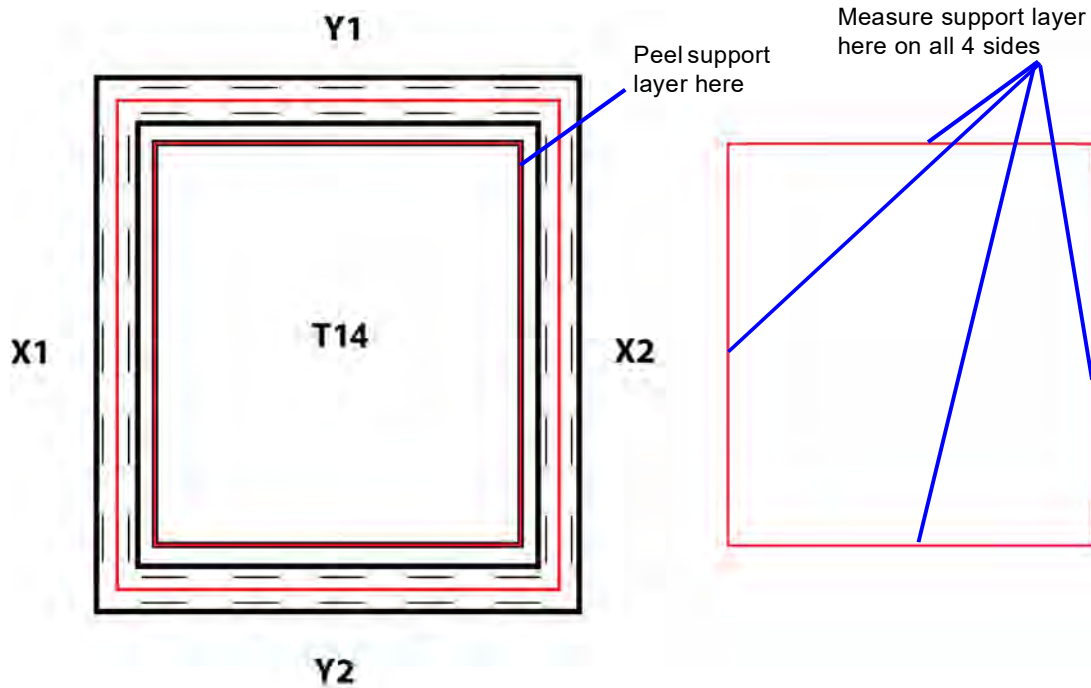

- d. If the value measured in [step c](#) above is within  $\pm 0.0005$  in. (0.01 mm) of the model tip's slice height of 0.010 in. (0.254 mm), the printer is calibrated for the Z axis and an adjustment is not required. Proceed to [step 4](#).
- e. If the value measured in [step c](#) above is not within  $\pm 0.0005$  in. (0.01 mm) of the model tip's slice height you will need to enter a Z offset adjustment using the **Up** and **Down** buttons within the Manual Tip Calibration page. Each button press equates to one ten thousandths of an inch.



- Use the **Down** button to enter the value obtained in [step c](#) above if this value is less than the tip's slice height. For example, if you measured an average of 0.0080 in. (0.2032 mm) for a tip with a slice height of 0.010 in. (0.254 mm), press the **Down** button until 0.0080 (0.2032) is displayed within the *Slice Height* field.

Figure 17: Z Offset Adjustment

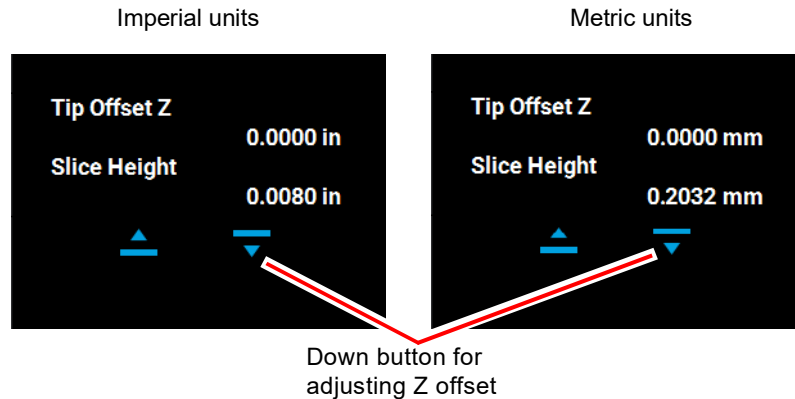

- Use the **Up** button to enter the value obtained in [step c](#) above if this value is greater than the tip's slice height. For example, if you measured an average of 0.0120 in. (0.3048 mm) for a tip with a slice height of 0.010 in. (0.254 mm), press the **Up** button until 0.0120 (0.3048) is displayed within the *Slice Height* field.

Figure 18: Z Offset Adjustment

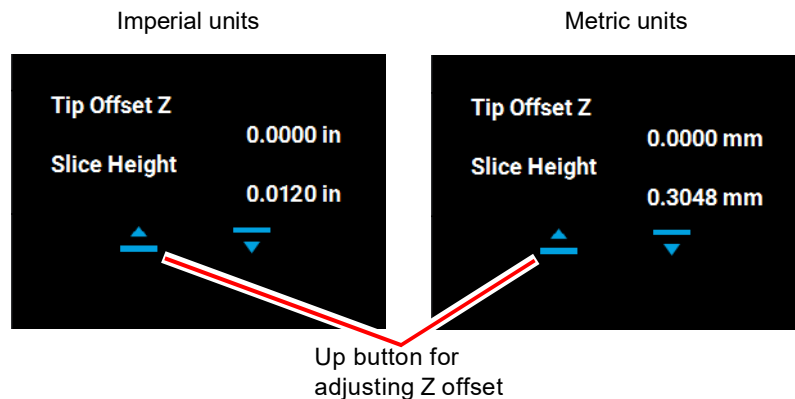

- f. If a Z offset adjustment is required you will need to rebuild the calibration part. To do so:
  - After entering your Z offset adjustment press the **Apply** button within the Manual Tip Calibration page (see [Figure 9 \(page 146\)](#) for button location). Your calibration adjustment(s) will be saved. If you continue to change the adjustment values, you must press the **Apply** button again to save the changes.



The **Cancel** button can be used to reset an adjustment value entered prior to pressing the **Apply** button. Once the **Apply** button is pressed, values will be saved and the printer's calibration settings will reflect the adjustment value entered. Use caution when entering an adjustment value to ensure it is correct prior to pressing the **Apply** button.

- After pressing the **Apply** button, the **Close** button will appear. Press the **Close** button to return to the initial Tip Calibration page.

Figure 19: Close Button Location

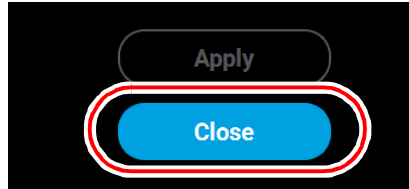

- Repeat [step 1](#) above to build a calibration part.
  - Repeat the instructions in [step 3](#) above. Continue to check and adjust for Z offset until the support layer matches the model tip slice height  $\pm 0.0005$  in. (0.01 mm).
4. Once you're finished adjusting for XY and Z, press the **Apply** button within the *Manual Tip Calibration* page and your calibration adjustment(s) will be saved. Press the **Close** button to exit the page.

## Touchscreen Calibration



A stylus pen should be used when performing this calibration to ensure precise calibration. Do not use your fingertip to perform this calibration. If a stylus pen is not available, a pencil eraser may be used.

You have the option of recalibrating the printer's touchscreen display. Extreme care must be taken when performing this calibration as an improperly calibrated touchscreen can lead to button accuracy issues.

To recalibrate the touchscreen:

1. Open the Calibration page by selecting the **Calibration** button within the *Tools* page.
2. Press anywhere within the Touchscreen Calibration row.

Figure 20: Touchscreen Calibration Row

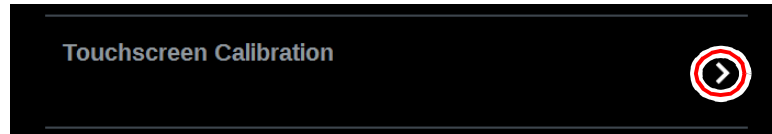

3. A dialog will be displayed asking you if you want to recalibrate the touchscreen, press the **Yes** button to confirm.

Figure 21: Recalibrate Touchscreen Confirmation Page

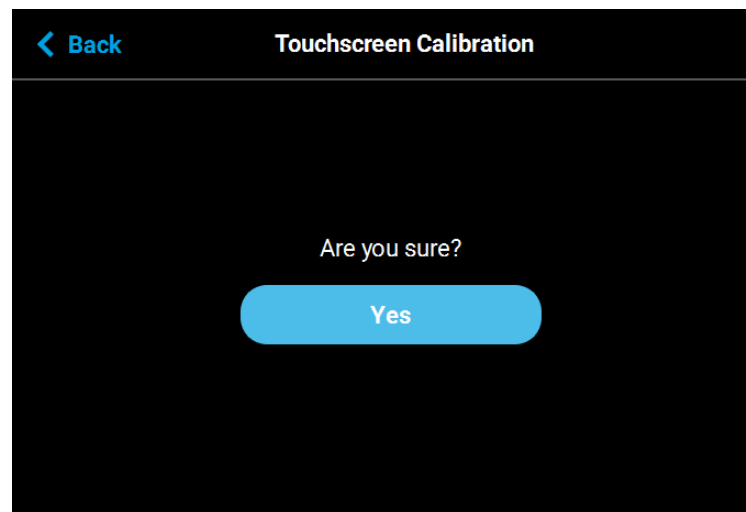

4. A dialog is displayed with instructions for recalibrating the touchscreen. Using a stylus, touch the screen in the center of the calibration point displayed. Repeat this process for the remaining calibration points (1 point for each of the 4 corners of the screen).



The graphic displayed within the center of the dialog represents the time remaining before the touchscreen calibration times out. The black portion will fill the perimeter of the gray circle in a clockwise direction. You must touch the calibration point displayed within the screen before the black portion of the graphic completes a full circle. The timer will reset for each of the 4 calibration points displayed. If you wish to exit the page without calibrating the screen simply wait until the black portion of the graphic completes a full circle; the dialog will close and you will be returned to the *Calibration* page.

5. Once finished, your calibration settings will be saved and the dialog will close. You will be returned to the *Calibration* page.

Figure 22: Touchscreen Calibration procedure



## XY Gantry Calibration

The printer is designed to automatically perform an XY Gantry Calibration as part of its initialization and startup process. This calibration moves the gantry to ensure it can travel properly throughout the build envelope and determines the gantry's reference in relation to the platen. Each time the printer is powered ON, it will automatically perform this calibration. The XY Gantry Calibration is responsible for finding the home position for the X and Y axes. The home position is a set location the printer references for all movements.

When performing the XY Gantry Calibration the printer will move the head at a low velocity to the full extents of travel in the X and Y axis. The homing process uses mechanical hard stops in conjunction with commanded motion control while actively monitoring servo motor following error. After XY gantry homing has completed, the extent of travel in X and Y is compared against an upper and lower limit, and an error is generated if travel is outside of those limits.

The commanded motion used to determine all four gantry hard stop locations is identical. The controller sets upper time and distance limits for each hard stop location. These limits are used to ensure hard stop engagement occurs within expected parameters.

# Z Zero Calibration

The printer automatically initiates a Z Zero Calibration before each job is built; "PREPARING" will be displayed within the Build Status Display of the User Interface while this process is occurring (see "Build Status Display" (page 41)). Z Zero Calibration must complete successfully before a build will begin. This calibration requires no user interaction and sets the reference point between the model tip and the substrate to ensure proper positioning for the first layer of a build.

When performing the Z Zero Calibration a purge of the model tip will be performed. The head will then be positioned over the back of the platen and the Z stage will move upward until the model tip is deflected; this deflection is used to calibrate the toggle sensor. The printer will then cool the model tip to a temperature below 200°C (392°F). Once cooled, the printer will perform four tip touches, one per each of the four quadrants of the build tray, by moving the Z stage upward within that quadrant until the model tip is deflected. Z Zero positioning is then determined based on the average Z stage position of the four tip touches; the printer will set the Z Zero position.



If any of the four tip touches used to determine Z Zero is greater than 0.01" away from the average, homing will fail and the build will be aborted with a "Substrate Not Level" error.

## Tip Wipe Height Adjustment

### Required Tools

- 3 mm hex wrench

### Adjusting Tip Wipe Height



Always wear gloves when performing maintenance within the oven enclosure or other high temperature areas.

1. Power OFF the printer. See "Powering Off" (page 172).
2. Open the front top cover.
3. Open the oven door.
4. Manually move the model head (left side) back and forth above the model tip wipe assembly (left side). Verify that the brush and flicker both make contact with the tip shield.
5. If necessary, adjust the tip wipe height.
  - a. Using a 3mm hex wrench, loosen the tip wipe mounting screw at the back of the oven enclosure. See [Figure 23](#)
  - b. Adjust the height of the tip wipe so that the tops of the brush and flicker just contact the bottom of the head tip shield.

- c. Tighten the tip wipe assembly mounting screw.
  - d. Manually move the head back and forth to verify that the brush and flicker are contacting the tip shield without extreme resistance.
6. Repeat **step 4** and **step 5** above for the support head (right side) and support tip wipe assembly (right side).

**i** Make sure that the toggle bar is in the lower position when verifying/adjusting the height of the support tip wipe assembly.

Figure 23: Tip Wipe Detail

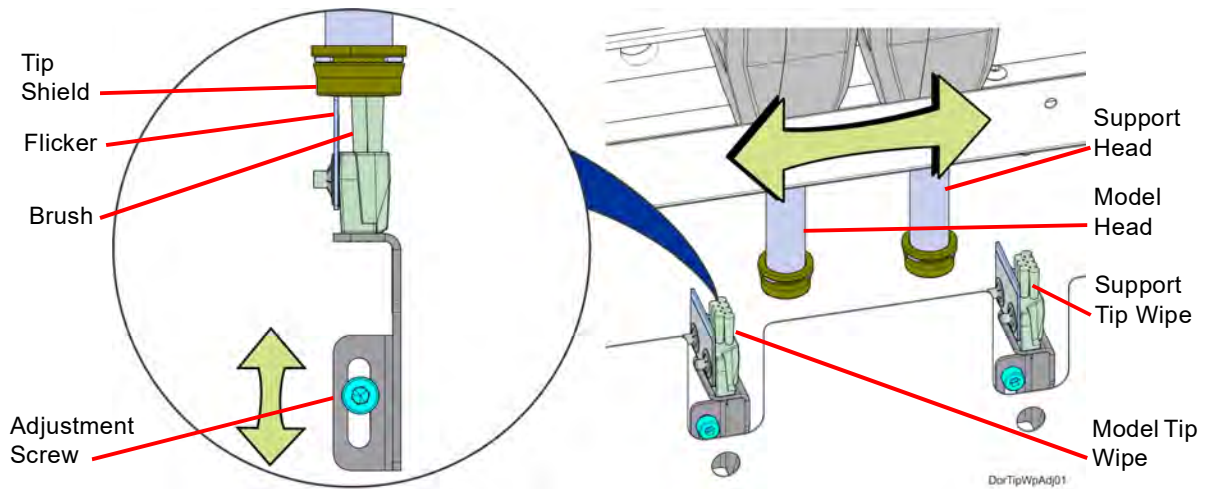

# 7 MAINTENANCE

This chapter describes various maintenance tasks that will routinely need to be performed on the F120 Printer.

## Updating Controller Software



**NOTE:** When updating the printer's controller software version, the printer must be in an idle state.

Controller Software can be updated using one of the following three methods:

- Installing from a USB Flash drive that contains the software update file
- Navigating to the update file on your workstation PC; After placing the printer into upgrade mode (see "Update Software" (page 88)), navigate to and install the upgrade file from its saved location on your workstation PC.
- Selecting push notifications automatically sent via GrabCAD Print; After receiving a notification from GrabCAD Print that a software upgrade is available, follow the on-screen prompts and instructions to install the upgrade.

You have the option of updating Controller Software via any of these methods; however, the USB Flash drive method is the preferred method.



Updating Controller Software will erase all job files from the Job Queue (files within the Sample Queue (Internal Storage) will be retained). After completing the software upgrade, you will need to resend jobs to the printer.

## USB Flash Drive Method

1. Save the software upgrade file to a USB flash drive.
2. Insert the USB flash drive into one of the available USB ports on the F120 printer.

3. On the printer touchscreen, open the Tools page by pressing the **Tools** button within the Navigation Menu.

Figure 1: Tools Page



4. Open the Maintenance page by pressing the **Maintenance** button within the Tools page.



5. From the Maintenance Page, select **USB Tools** and then select **UPG Install**.

Figure 2: USB Tools

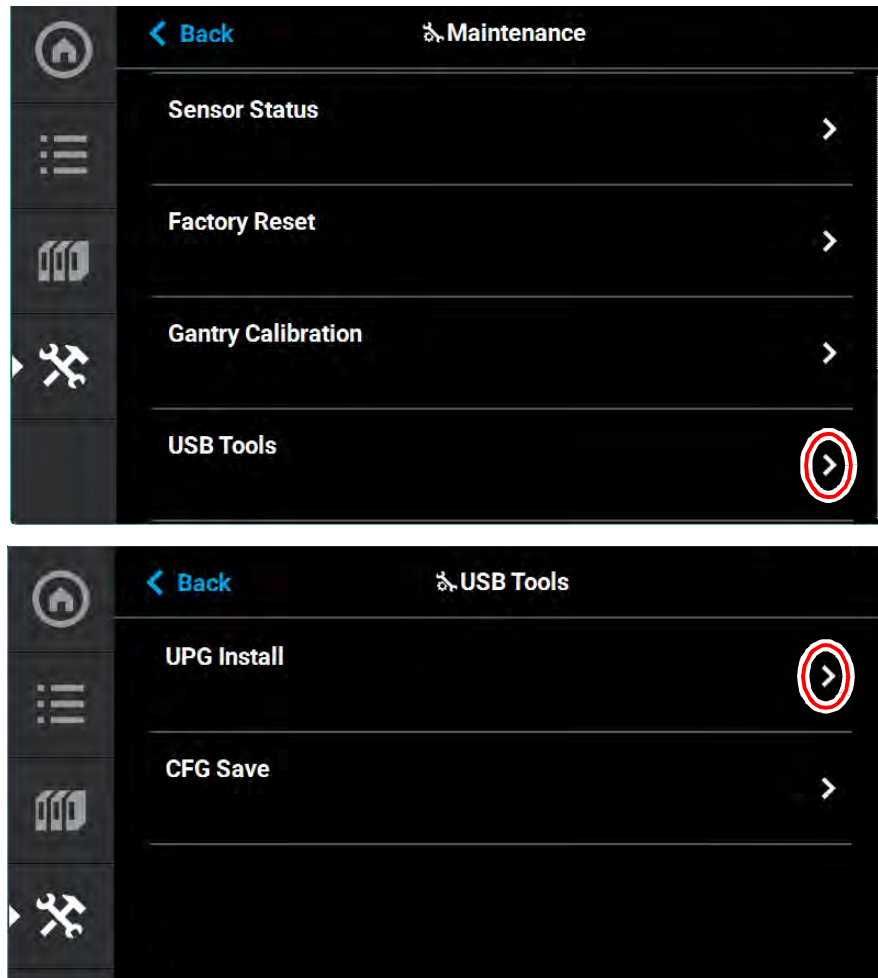

6. Select **USB**.

Figure 3: Load File

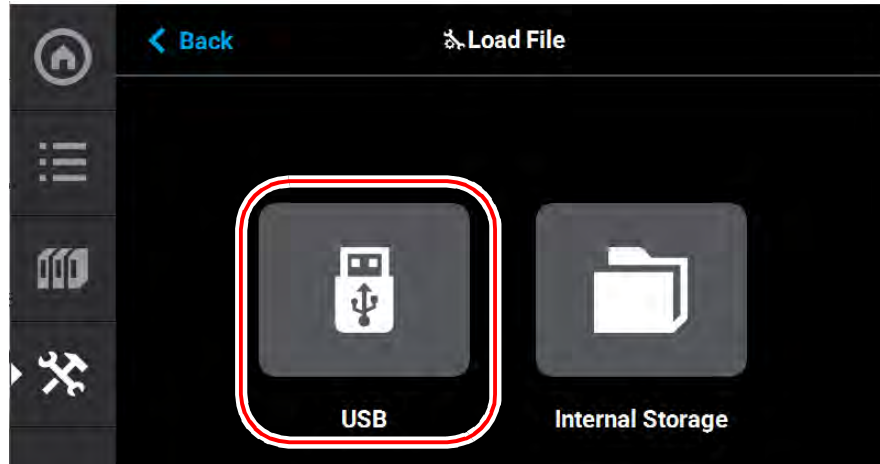

7. Navigate to and select the upgrade file from its saved location on the USB drive.

Figure 4: Upgrade File Location

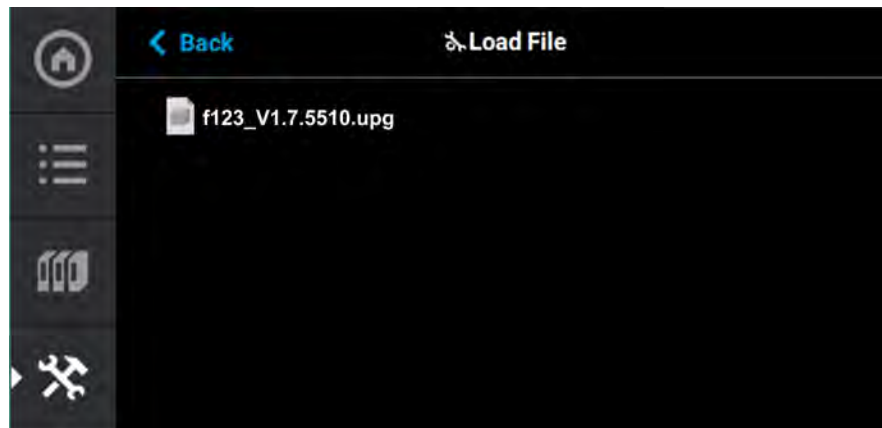

8. The upgrade file will install. The screen will display the status until the upgrade is complete.

Figure 5: Upgrade Status

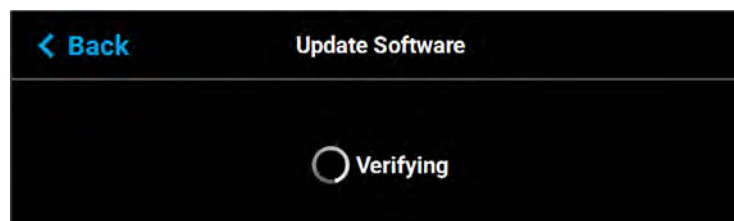

 Updating Controller Software will erase all job files from the Job Queue (files within the Internal Storage will be retained). After completing the software upgrade, you will need to resend jobs to the printer.

## GrabCAD Print Method

To update Controller Software via GrabCAD Print, navigate to <http://help.grabcad.com/article/196-printer-firmware-management> and follow the procedure for “Updating the printer’s firmware”.

## Exporting System Configuration (.CFG) File

If your system is receiving fault determination codes, you may need to export a configuration (.cfg) file from your system to send to Customer Support. System configuration files can be exported using one of the following three methods:

- Saving to a USB Flash drive directly from the F120 printer
- Saving to a location on your workstation PC
- Saving via GrabCAD Print

You have the option of exporting system configuration files via any of these methods; however, the USB Flash drive method is the preferred method.

## USB Flash Drive Method

1. Insert the USB flash drive into one of the available USB ports on the F120 printer.
2. On the printer touchscreen, open the Tools page by pressing the **Tools** button within the Navigation Menu.

Figure 6: Tools Page

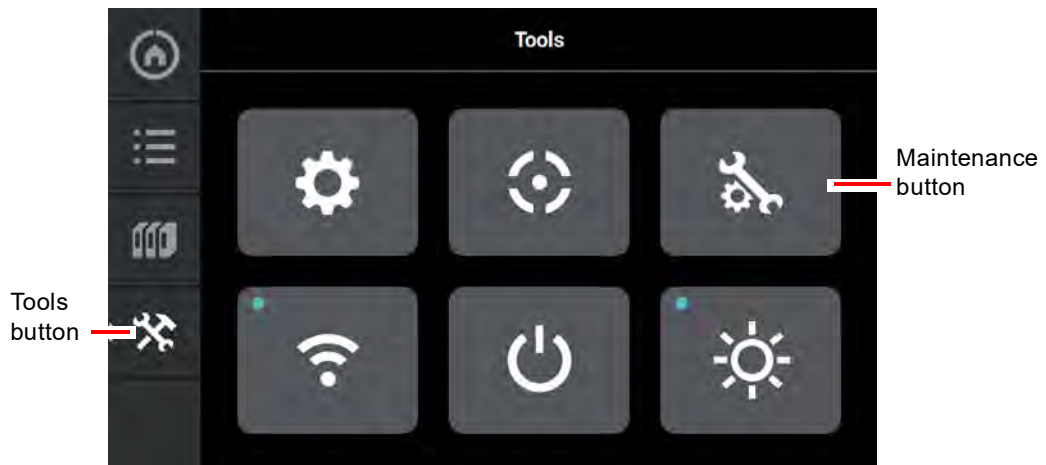

3. Open the Maintenance page by pressing the **Maintenance** button within the Tools page.

4. From the Maintenance Page, select **USB Tools** and then select **CFG Save**.

Figure 7: USB Tools

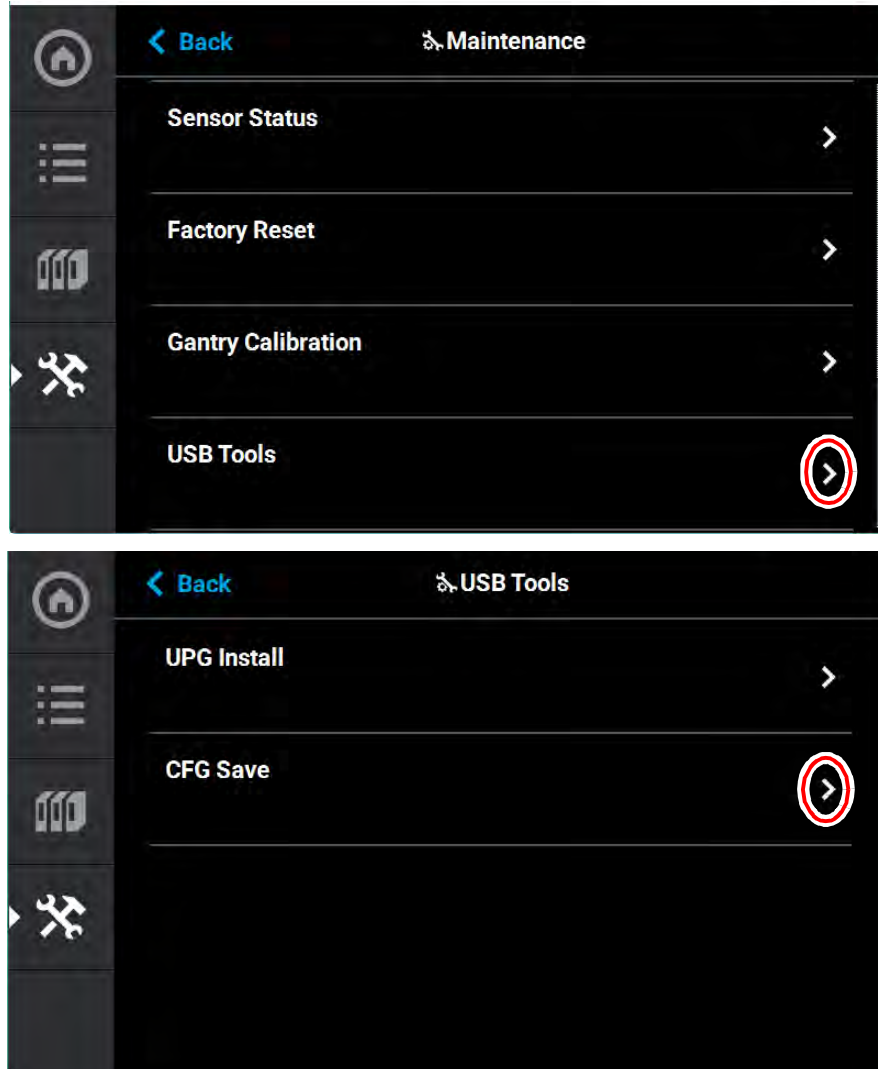

5. Select **USB**.

Figure 8: CFG Save



6. Navigate to a save file location on the USB drive and select the **Download** button.

Figure 9: Save File Location

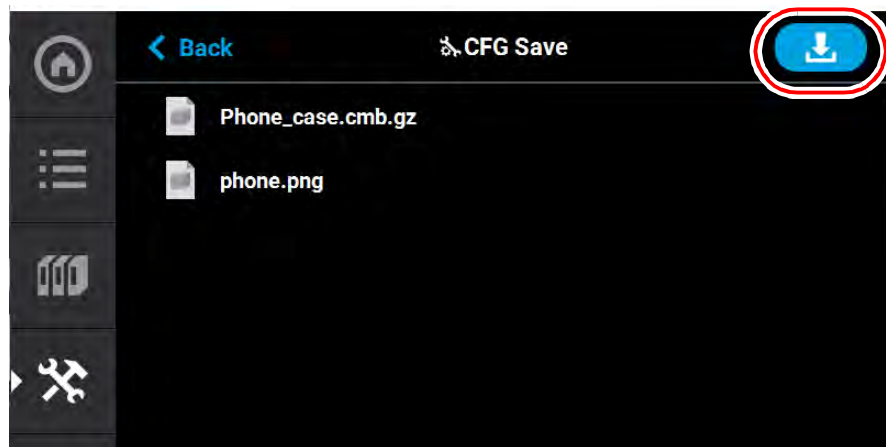

7. The configuration file will download to the USB flash drive. Select **Accept** when the file download is complete.

Figure 10: Configuration File Saved

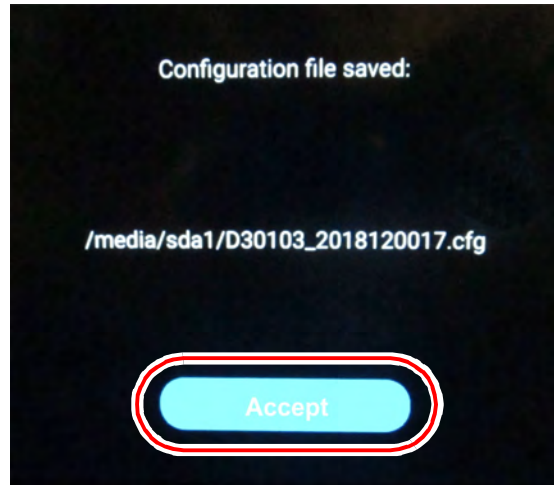

## GrabCAD PRINT METHOD

For detailed instructions on exporting a system configuration file navigate to: <http://help.grabcad.com/article/196-printer-firmware-management> and follow the procedure for "Exporting the printer configuration".

# Maintenance Schedule



## Warning: Hot Surface Hazard

Always wear proper heat protective gloves and clothing when handling items inside the oven, as surfaces within the oven can be very hot.

Maintenance tasks must be performed on a regular basis in order to maintain optimal system operation. Table 1 outlines the general maintenance schedule for the F120. Detailed instructions for each task make up the rest of this chapter.

Table 2 lists part numbers for various replacement consumable items. Use the part numbers listed in this table when ordering replacement parts from Stratasys or your regional Stratasys office.

Table 1: Maintenance Schedule

Weekly	Monthly	As Needed	Maintenance Task
X			“Cleaning the Oven Chamber” (page 167)
X			“Cleaning the Platen” (page 167)
	X		“Clean/Inspect Tip Wipe Assemblies” (page 167)
		X	“Cleaning the Exterior Surface of the Printer” (page 170)
		X	“Cleaning the Touchscreen Display” (page 170)

Table 2: Replacement Consumables

Part Number	Description
123-00400	Model Head (standard)
123-00400	Support Head (standard)
123-00302	F170 substrate 1 box of 16
123-00305	Tip shield kit - 4 sets
123-00306	2-pack of tip wipe assemblies (see “Clean/Inspect Tip Wipe Assemblies” (page 167)).

# Weekly Maintenance

## Cleaning the Oven Chamber

**Warning: Hot Surface Hazard**

Always wear proper heat protective gloves and clothing when handling items inside the oven, as surfaces within the oven can be very hot.

The purge chute is designed to guide purged material debris from the tip wipe assemblies to the bottom of the oven chamber for disposal. Purged material debris then collects within the bottom of the oven chamber, beneath the platen. Do not allow excess material debris to accumulate in the oven chamber as this could cause damage to the printer. Clean the oven chamber on a weekly basis to remove build material debris and dust. A standard vacuum can be used to clean this area if needed. If excessive accumulation occurs vacuum the oven chamber as needed.

## Cleaning the Platen

The steel platen provides the level surface on which parts are built (see [Figure 7 \(page 23\)](#) for platen overview). A substrate is securely affixed to the platen by the substrate ejection handle. If debris collects on the platen, it can adversely affect substrate adhesion.

1. Remove the substrate from the platen.
  - Push down on the substrate ejection handle to release it from the platen.
  - Slide the substrate from the platen.
2. Carefully remove purged material debris that have fallen into the openings of the platen.
  - A standard vacuum can be used to clean the platen.

# Monthly Maintenance

## Clean/Inspect Tip Wipe Assemblies

The tip wipe assemblies should be cleaned once a month. While cleaning the assemblies, inspect the flicker/brush assemblies for wear and replace as necessary when wear is detected.

Once material is purged from a tip, the flicker portion of the tip wipe assembly passes across the tip's opening, cutting purged material off in small segments. The brush portion of the tip wipe assembly then passes across the tip's opening cleaning the tip and its tip shield. As a result, the flicker will wear at the location where the tip contacts its surface and eventually develop a notch large enough for the tip to completely pass through the flicker; a notched flicker cannot properly cut purging material. Similarly, material can become embedded within the bristles of the brush resulting in clumping; clumped bristles cannot properly clean a tip or its tip shield. The tip wipe assembly should be replaced once a significant notch develops within



the flicker portion of the assembly or whenever bristle clumping (which cannot be removed with a brush) is apparent within the brush portion of the assembly. The tip wipe assembly is replaced as a single unit.

To clean the tip wipe assembly and inspect its components:

1. Ensure that the printer is stopped (idle) and is not building.
2. Open the oven door.

**Caution:**

Depending on how long the oven has been allowed to cool, components may be hot. Wear the safety gloves provided in the Welcome Kit to perform all remaining steps.

3. Remove the model side tip wipe assembly by lifting it upward until it clears its locating pins.

Figure 11: Tip Wipe Assembly Removal

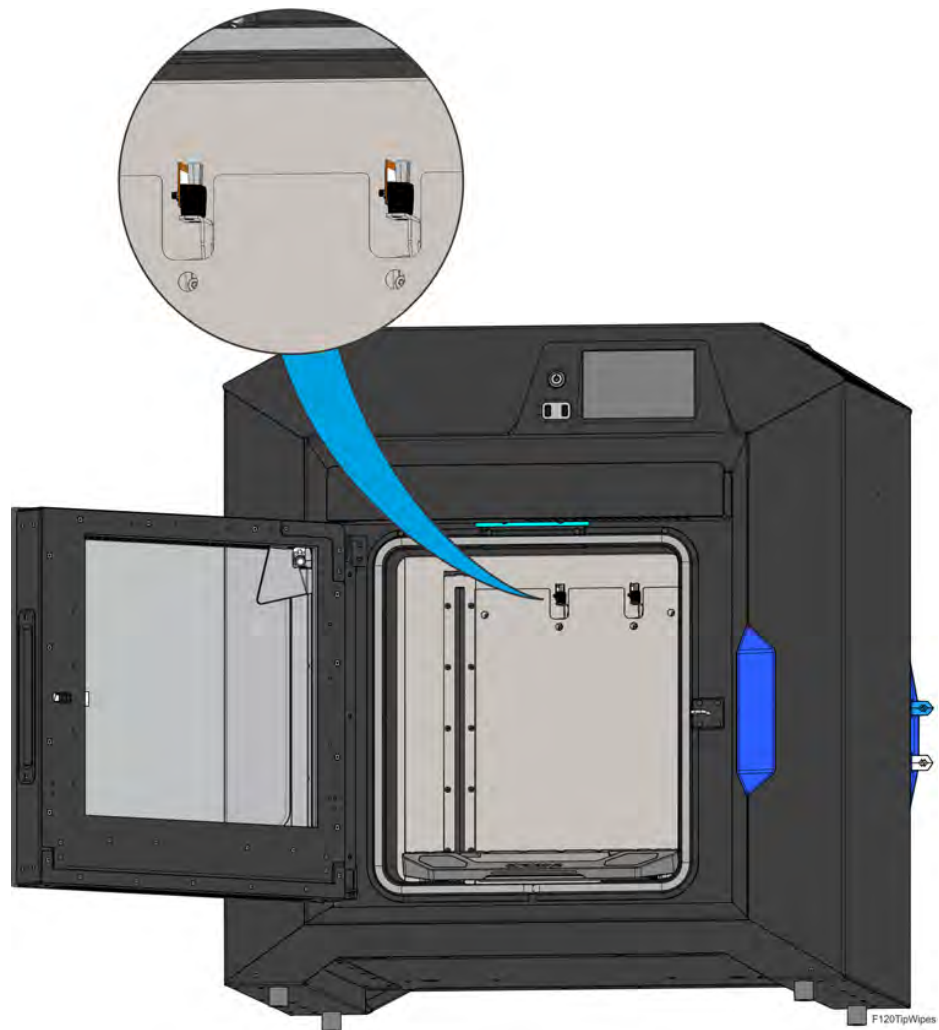

- Repeat [step 3](#) above to remove the support side tip wipe assembly.



If the head is positioned above the purge area it may impede your ability to remove the tip wipe assemblies. Open the top cover and manually move the head away from the purge area.

- Clean and inspect the surface around the locating pins. Make sure that the tip wipe assemblies can sit flush on the surface.
- Inspect the flicker portion of the tip wipe assemblies. The top edge of the flicker should be straight and must not contain excessive notching/wear.
- Inspect the brush portion of the tip wipe assemblies. Brush bristles must not show evidence of wear (i.e. no notches in bristle pattern) and should not contain significant bristle clumping. Frayed bristles are acceptable as long as the top edge is even across all of the bristles.
- Replace one or both of the tip wipe assemblies if excessive wear is present. See [Table 2 \(page 166\)](#) for information on ordering replacement assemblies.
- The components of the assembly cannot be replaced individually. The entire tip wipe assembly (PN 123-00306) must be replaced if excessive wear is present on the flicker or the brush.

Figure 12: Tip Wipe Assembly Details

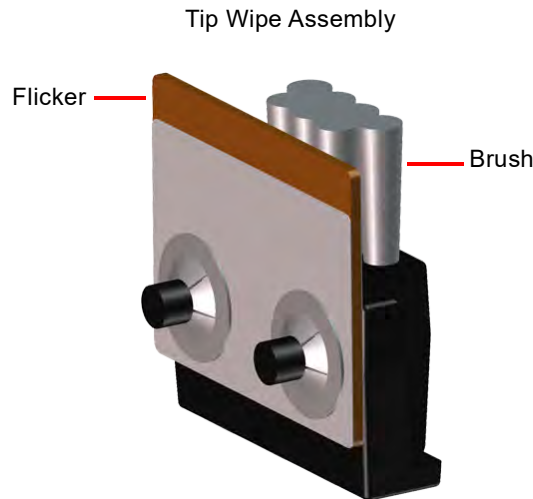

- Reinstall the support side tip wipe assembly by placing the assembly onto its locating pins and sliding the assembly downward.
- Repeat [step 9](#) above to reinstall the model side tip wipe assembly.

# As Needed Maintenance

## Cleaning the Exterior Surface of the Printer

The printer's exterior surfaces (doors and panels) may accumulate dust and periodically require cleaning. Exterior doors and panels, with the exception of the touchscreen display, can be cleaned using a slightly damp microfiber cloth (supplied in the Welcome Kit). The cloth should be only slightly damp to ensure that water does not enter the printer. Excess water can cause damage to interior components.

## Cleaning the Touchscreen Display

**Caution:**

Using a cleaner which contains ammonia and/or alcohol can damage the touchscreen. Only a suitable LCD cleaning solution and microfiber cloth (included in the Welcome Kit) should be used to clean the touchscreen display.

As needed, to remove smudge marks and buildup, clean the touchscreen display using the LCD cleaner and microfiber cloth provided in the Welcome Kit.

Apply an adequate amount of LCD cleaning solution to the provided microfiber cloth and then gently wipe the exterior surface of the touchscreen display to clean its surface. It is recommended that you apply LCD cleaner to the microfiber cloth rather than applying cleaner directly to the touchscreen display, as excess moisture may damage the display.

## Inspecting and cleaning the tip shields

The tip shields may accumulate purged material or debris. As required, this material can be removed by manually wiping the tip shields with a clean cloth.

## Cleaning the Oven Door glass Surfaces

**Required Tools**

- 2.5 mm hex wrench

**Accessing the Oven Door Glass**

1. Power off the printer. See "Powering Off" (page 172).
2. Allow the oven to cool.
3. Open the oven door.

- Using a 2.5 mm hex wrench, remove the inside door panel mounting screws (11). See Figure 40 (page 200).

Figure 13: Inside door panel mounting screw locations

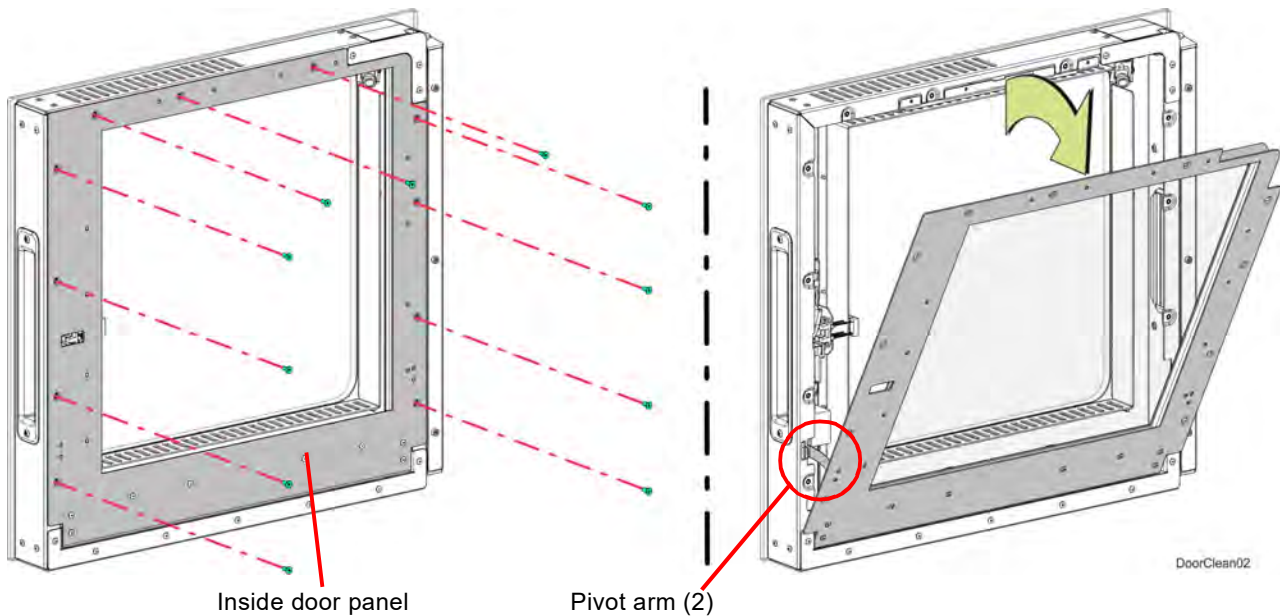

- Pivot the inside door panel away from the door assembly. The pivot arms will prevent the door panel from fully separating. See Figure 13.
- Clean the glass surfaces with a commercial glass cleaner.

### Installing the Door Panel

- Push the top of the door panel toward the door assembly.
- Close the door panel and make sure that the panel and frame mounting holes are aligned.
- Using a 2.5 mm hex wrench, install the inside door panel mounting screws (11). See Figure 13.



Do not over-tighten the inside door panel mounting screws.

- Close the oven door.

# Customer Replaceable Units

The following service procedures outline the replacement instructions for the customer replaceable units of the F120 printer.

## Powering Off

**Warning: Electrical Shock Hazard.**

Power OFF the printer and disconnect the power cord before replacing any of the customer replacement units.

**Powering OFF the Printer**

1. Depress the blue ON/OFF power button.

Figure 14: ON/OFF power button location

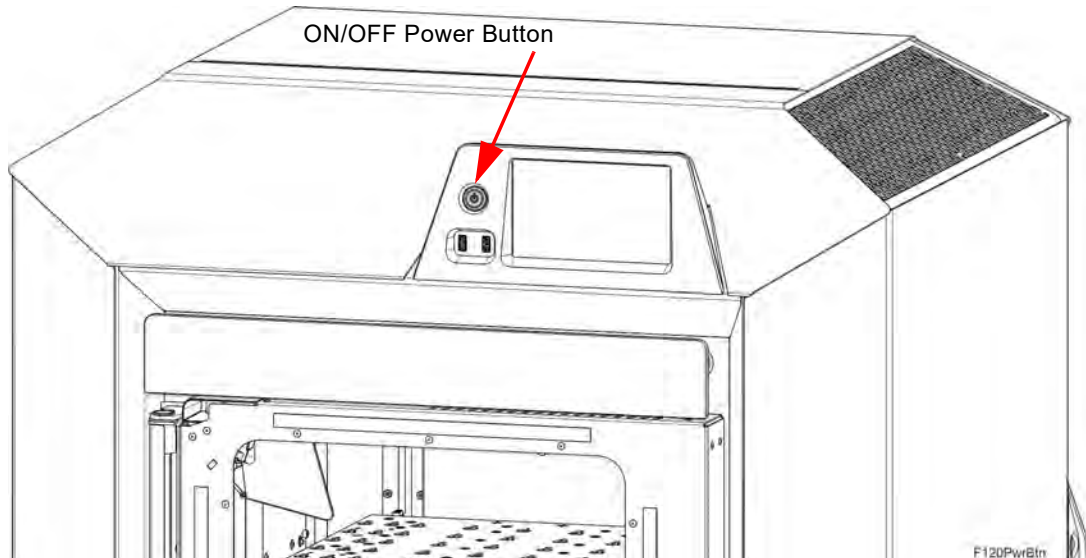

2. Press Accept on the touchscreen display. Wait approximately 25 seconds for the printer to power down.

3. Remove the AC power cord from the rear of the system.

Figure 15: AC power cord location

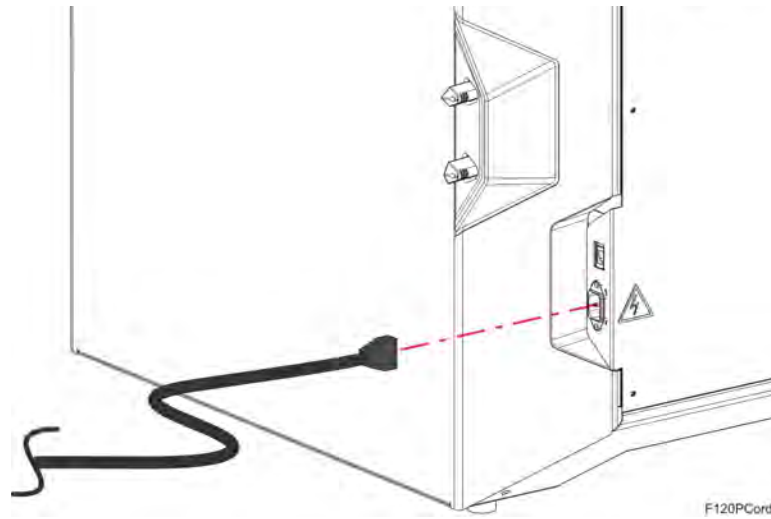

## Rear Panel

### Required Tools

- 3 mm hex wrench

### Removing the Rear Panel

**Note:**

Removal of the rear panel requires the removal of the AC power cord. Do not install the AC power cord with the back panel removed.

1. Power OFF the printer, see “Powering Off” (page 172).
2. If present, disconnect the network cable from the Ethernet port.
3. Using a 3 mm hex wrench, remove the rear panel mounting screws (10). See Figure 16 (page 174).
4. The rear panel has formed tabs that allow it to hang on the printer frame. Remove the rear panel by lifting upward and pulling away from the printer.

Figure 16: Rear Panel Mounting Screws

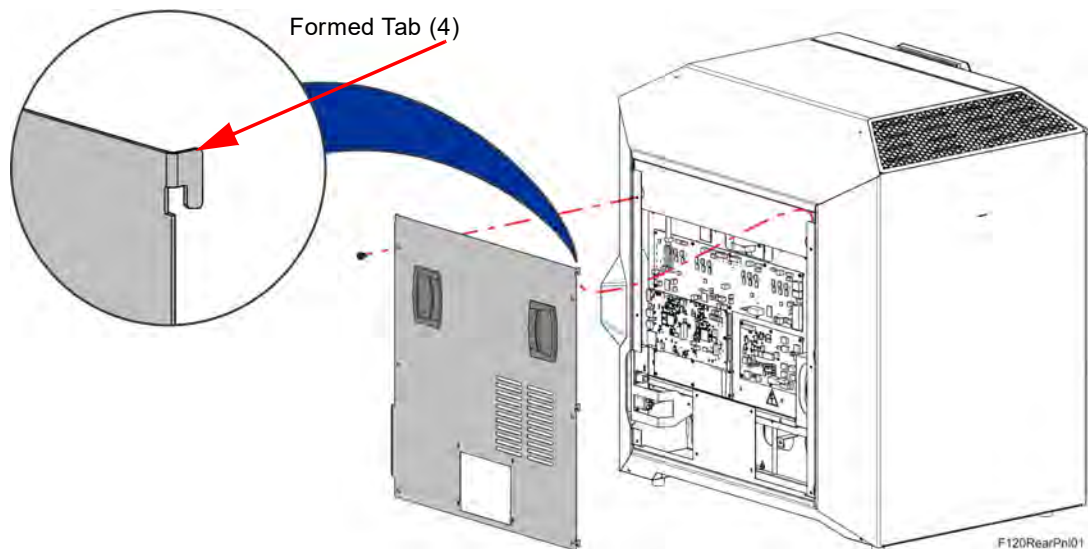

### Installing the Rear Panel

1. Insert the rear panel formed tabs into the slots in the side and cover panels. See Figure 16 (page 174).
2. Align the rear panel with the mounting holes in the frame. See Figure 16 (page 174).
3. Using a 3 mm hex wrench, loosely install the rear panel mounting screws (10). See Figure 16 (page 174).

4. Tighten the rear panel mounting screws (10) in the order shown in Figure 17 (page 175). Torque to 21 in-lbs.

Figure 17: Rear Panel Screw Installation Order

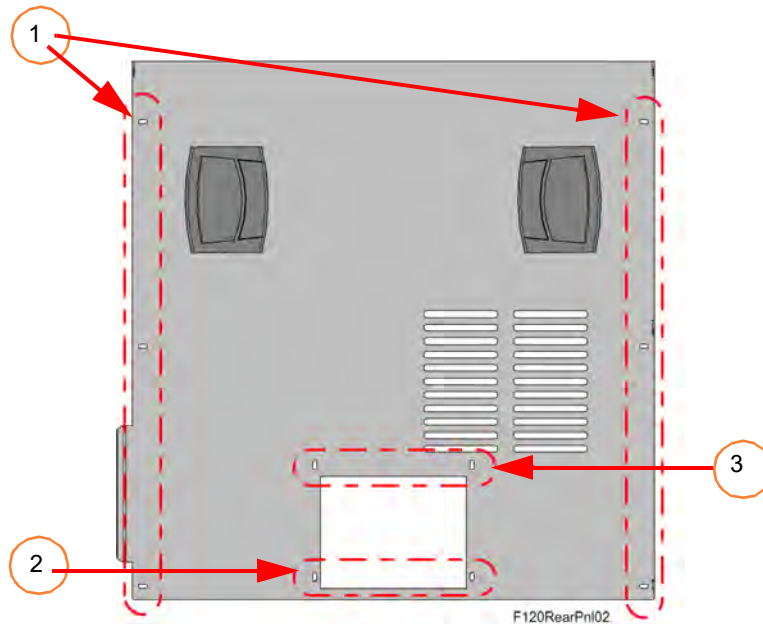

5. Tighten the rear panel mounting screws (16).

## Right and Left Side Panels

### Required Tools

- 3 mm hex wrench

### Removing the Side Panels

1. Power OFF the printer, see “Powering Off” (page 172).
2. Remove the rear panel. See “Removing the Rear Panel” (page 174).
3. Open the oven door to release the top cover latch.
4. Open the top cover.
5. Using a 3 mm hex wrench, remove the side panel mounting screws (2). See Figure 18 (page 176).



6. Press and hold down the side panel retaining slot on the cover support bracket. See Figure 18 (page 176).

Figure 18: Side Panel Mounting Screw Locations (right side panel shown)

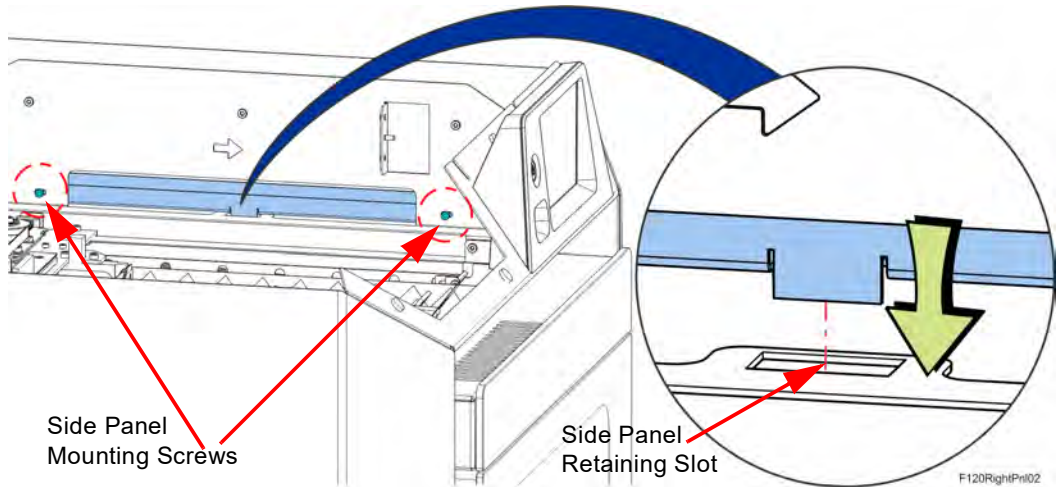

7. While holding down the retaining slot on the cover support bracket, tilt and lift the side panels off the retaining pins (3) at the base of the oven frame. See Figure 19 (page 177).

Figure 19: Side Panel Retaining Pins Detail (right side panel shown)

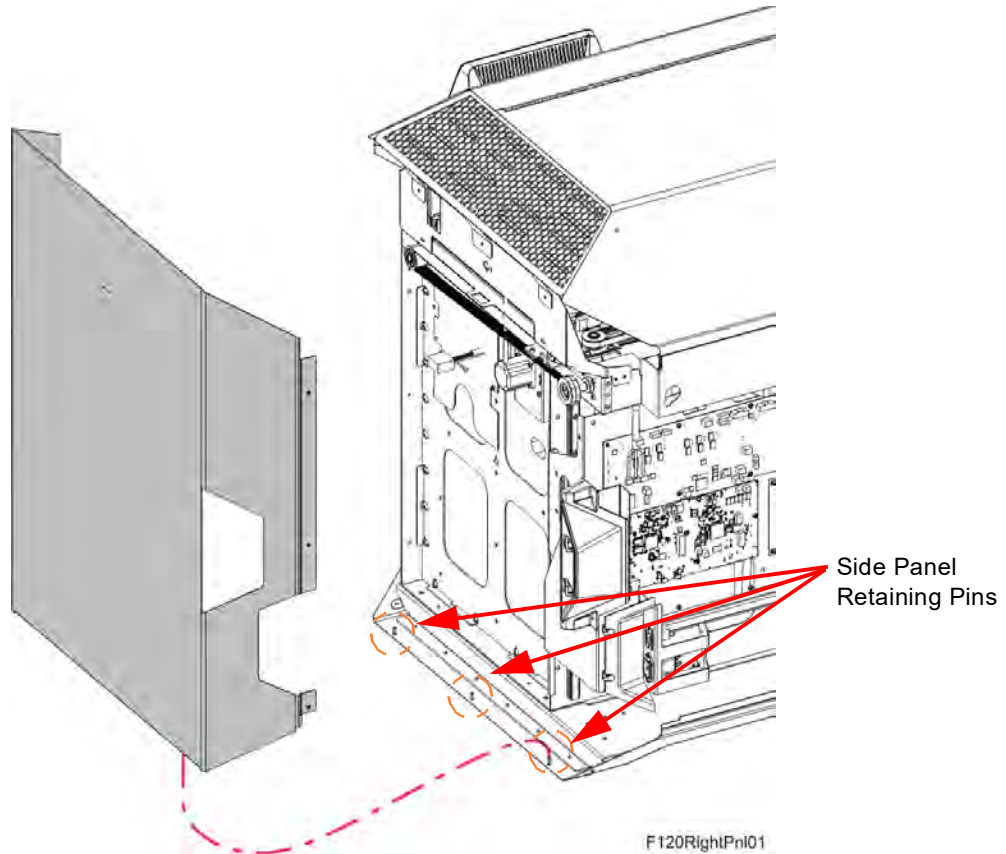

8. Remove the side panel from the printer.

### Installing the Side Panels

1. Install the side panel to the retaining pins (3) at the base of the printer frame. See Figure 19 (page 177).
2. Align the mounting holes (2) in the side panel's welded channel with the holes in the printer frame. Make sure that the tab at the bottom of the channel engages the side panel retaining slot. See Figure 18 (page 176).
3. Use a 3 mm hex wrench to reinstall the mounting screws (2). Torque to 21 in-lbs. See Figure 19 (page 177).
4. Close the top cover.
5. Install the rear panel. See "Installing the Rear Panel" (page 174).

## Right and Left Side Louver Panels

**Note:**

The following procedure describes and depicts replacement of the right side louver panel only. The left side louver panel replacement procedure is identical to the right side panel replacement procedure except that the left side panel must be removed for access.

**Required Tools**

- 3mm hex wrench

**Removing the Louver Panels**

1. Power OFF the printer. See Powering Off on page 5-5.
2. Remove the rear panel. See “Removing the Rear Panel” (page 174).
3. Remove the right side panel. See “Removing the Side Panels” (page 175).
4. Using a 3 mm hex wrench, remove the right side louver panel mounting screws (3) that secure the louver panel to the cover support bracket. See Figure 20 (page 178).
5. Using a 3 mm hex wrench, remove the right side louver panel mounting screws (2) that secure the louver panel to the cover buttress. See Figure 20 (page 178).
6. Gently pull the louver panel away from printer until the formed bracket disengages from the rear cover standoff fastener. See Figure 20 (page 178).

Figure 20: Louver Panel Location (Right Side Shown)

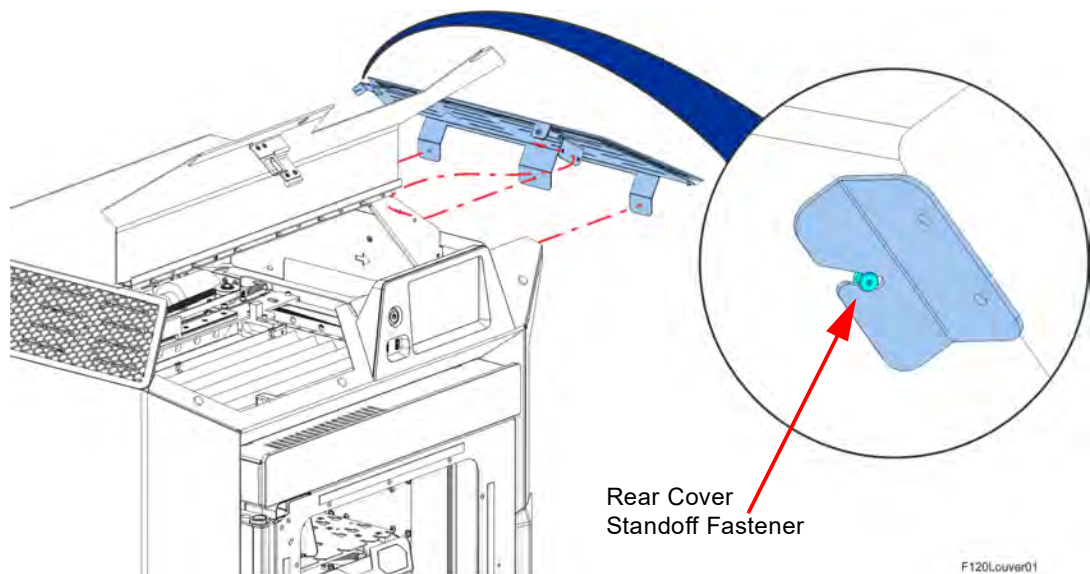

7. Remove the louver panel from the printer.

### Installing the Louver Panels

1. Engage the slotted mounting bracket of the louver panel with the rear cover standoff fastener.
2. Align the louver panel mounting holes (2) with the holes in the cover buttress.
3. Use a 3 mm hex wrench to reinstall the mounting screws (2) that secure the louver panel to the cover buttress. Torque to 21 in-lbs. See [Figure 20 \(page 178\)](#).
4. Use a 3 mm hex wrench to reinstall the louver panel mounting screws (3) that secure the louver panel to the cover support bracket. See [Figure 20 \(page 178\)](#). Torque to 30 in-lbs.
5. Install the right side panel. See “Installing the Side Panels” (page 177).
6. Install the rear panel. See Installing the Rear Panel on page 5-7.

## Top Cover Assembly

### Required Tools

- 3mm hex wrench
- 5 mm hex wrench

### Removing the Top Cover

1. Power off the printer. See “Powering OFF the Printer” (page 172).
2. Remove the rear panel. See “Removing the Rear Panel” (page 174)
3. Remove the right and left side panels. See “Removing the Side Panels” (page 175).
4. Remove the right and left side louver panels. See “Removing the Louver Panels” (page 178).
5. Using a 5 mm hex wrench, remove the screws (2) that secure the back cover to the top of the printer frame.
6. Open the oven door to release the top cover latch.
7. Open the front top cover.
8. Using a 3 mm hex wrench, remove the screws (4) that secure the cover assembly buttresses to the left and right side support brackets. See [Figure 21 \(page 180\)](#).
9. While holding the front cover open, gently disengage the cover buttresses from the retaining pins on the left and right side support brackets. See [Figure 21 \(page 180\)](#).

10. Lift and remove the cover assembly from the printer.

Figure 21: Top cover mounting screw locations

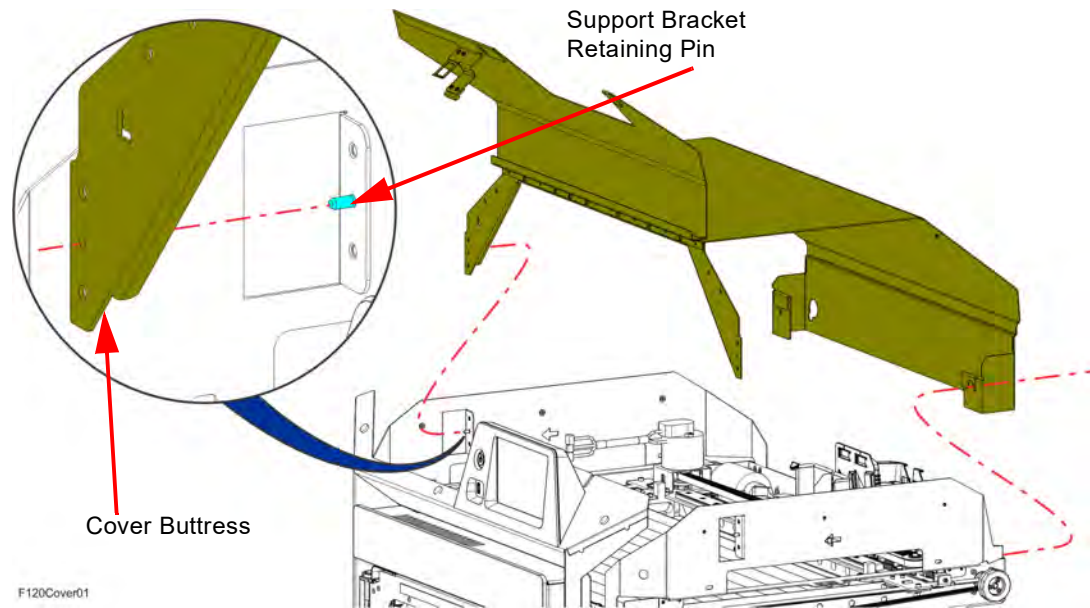

### Installing the Top Cover

1. Transfer the latch, sensor actuator and mounting hardware from the old front cover to the new cover assembly.



**Note:**

Install the sensor actuator so that it is biased toward the cover sensor inside the printer gantry.

2. While holding open the front cover, loosely install the cover assembly to the top of the printer so that the buttresses engage the retaining pins on the left and right side support brackets. See [Figure 21 \(page 180\)](#).
3. Using a 3 mm hex wrench, tighten the screws (4) that secure the cover assembly buttresses to the left and right side support brackets. See [Figure 21 \(page 180\)](#).
4. Using a 5 mm hex wrench, tighten the screws (2) that secure the back cover to the top of the printer frame. See [Figure 21 \(page 180\)](#).
5. Install the right and left side louver panels. See [“Installing the Louver Panels” \(page 179\)](#).
6. Install the right and left side panels. See [“Installing the Side Panels” \(page 177\)](#).
7. Install the rear panel. See [“Installing the Rear Panel” \(page 174\)](#).
8. Close the top cover.

## 3.3/5/12 VDC ATX Power Supply

### Required Tools

- 3mm hex wrench

### Removing the 3.3/5/12 VDC ATX Power Supply

1. Power OFF the printer, see “Powering Off” (page 172).
2. Remove the rear panel, see “Removing the Rear Panel” (page 174).
3. Remove the right side panel, see “Removing the Side Panels” (page 175)
4. Disconnect the input power cable from the power supply.
5. Disconnect the power supply cables from the I/O board (J16, J19, J20, J29).
6. Using a 3mm hex wrench, remove the power supply bracket mounting screw. See Figure 22.
7. Pivot and lift the bracket slightly to remove the power supply from the electronics bay.
8. Remove the power supply from the bracket.

Figure 22: 3.3/5/12 VDC ATX Power Supply Mounting Location

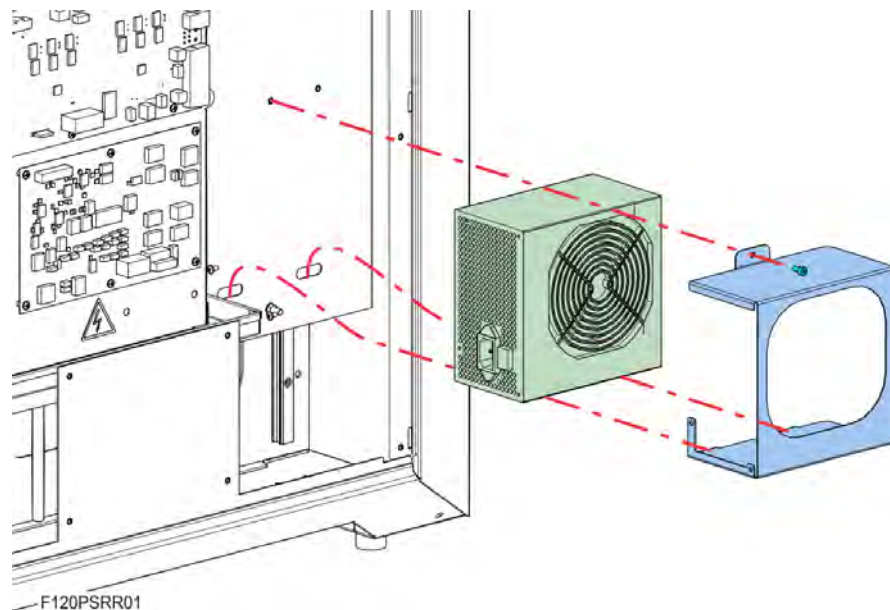

### Installing the 3.3/5/12 VDC ATX Power Supply

1. Transfer the mounting bracket to the new power supply.
2. Insert the bottom tabs of the power supply bracket into the slotted holes of the electronics bay panel. Pivot the power supply to its mounting orientation.
3. Use a 3mm hex wrench to reinstall the single mounting screw on top of the power supply bracket.
4. Connect the power supply cables to the I/O board (J16, J19, J20, J29).

5. Reconnect the input power cable to the 3.3/5/12 VDC ATX power supply.
6. Make sure that the switch on the power supply is in the ON position.
7. Reinstall the right side panel. See “Installing the Side Panels” (page 177)
8. Reinstall the rear panel. See “Installing the Rear Panel” (page 174).

## Oven Thermistor

### Required Tools

- 3 mm hex wrench

### Removing the Oven Thermistor

1. Power OFF the printer. See “Powering Off” (page 172).
2. Remove the rear panel. See “Removing the Rear Panel” (page 174).
3. Remove the right side panel. See “Removing the Side Panels” (page 175).
4. Disconnect the thermistor cable from the I/O board (J36).
5. Use a 3mm hex wrench to remove the mounting screw (1) that secures the thermistor to the oven wall. See Figure 23.
6. Remove the thermistor from the printer. See Figure 23.

Figure 23: Thermistor Detail

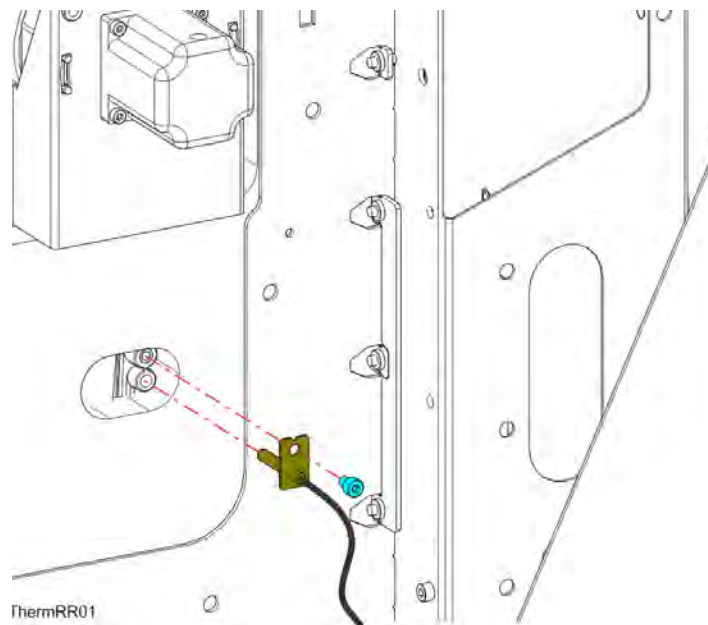

### Installing the Oven Thermistor

1. Align the oven thermistor with its mounting location and use a 3 mm hex wrench to reinstall the mounting screw (1). See Figure 23.
2. Route the oven thermistor wire through the printer and reconnect it to the I/O board (J36).

3. Reinstall the right side panel. See “Installing the Side Panels” (page 177).
4. Reinstall the rear panel. See “Installing the Rear Panel” (page 174).

## Replacing a Head

When a head reaches the 1500 build hour odometer limit, a warning will be displayed on the User Interface and the head’s Head Status Icon will be highlighted in red on the Materials page. You can continue using a head which has exceeded its odometer limit, but it is highly recommended that you change the head as part quality will be unpredictable. See “Replacing a Head” (page 111) for instructions on replacing a head.

## Head Ribbon Cables

### Required Tools

- 3 mm hex wrench

### Removing the Head Ribbon Cables

**Note:**

Make sure to disconnect the head ribbon cables while the printer is powered ON to ensure that auto-calibration occurs after re-installation.

1. With the printer powered ON, open the top cover.
2. Move the X bridge to the front of the gantry enclosure.
3. Disconnect the head ribbon cable connectors (2) from the tops of the material and support heads. See Figure 24 (page 184).
4. Power OFF the printer.
5. Remove the rear panel. See “Removing the Rear Panel” (page 174).



- Disconnect the head ribbon cable connectors (2) from the I/O board (J6 and J7). See Figure 24.

Figure 24: Head Ribbon Cable Connections

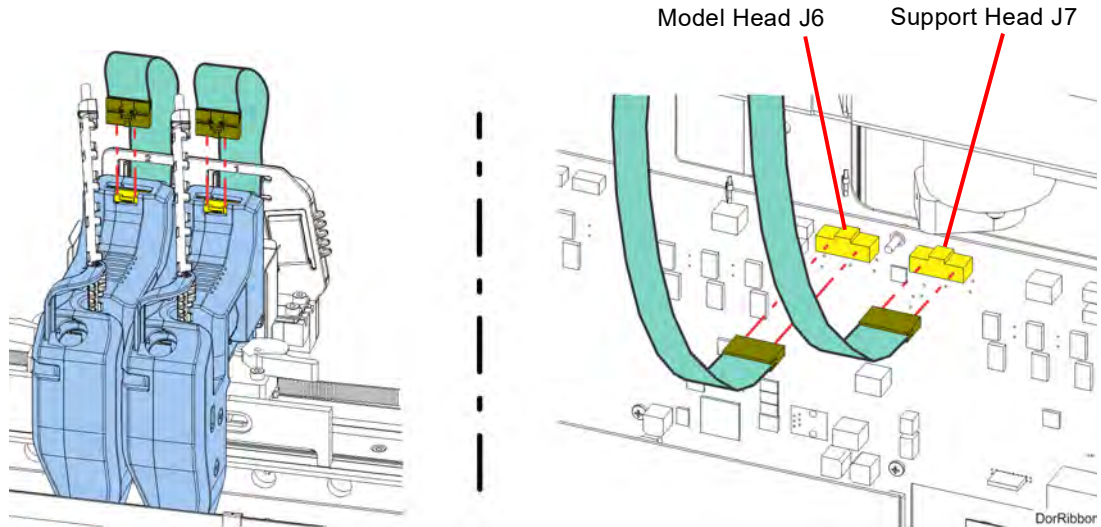

- Using a 3 mm hex wrench, remove the front ribbon cable bracket mounting screws (3) on the back of the toggle assembly. Retain the screws for re-installation. See Figure 25.

Figure 25: Front Ribbon Cable Bracket Mounting Screw Locations

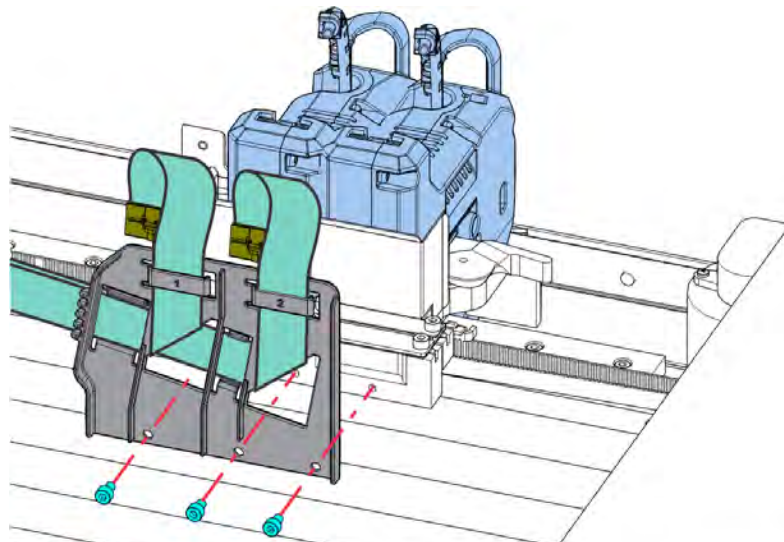

8. Lift and disengage the rear ribbon cable bracket from the back, top of the printer frame. See Figure 26.

Figure 26: Rear Ribbon Cable Bracket Mounting Detail

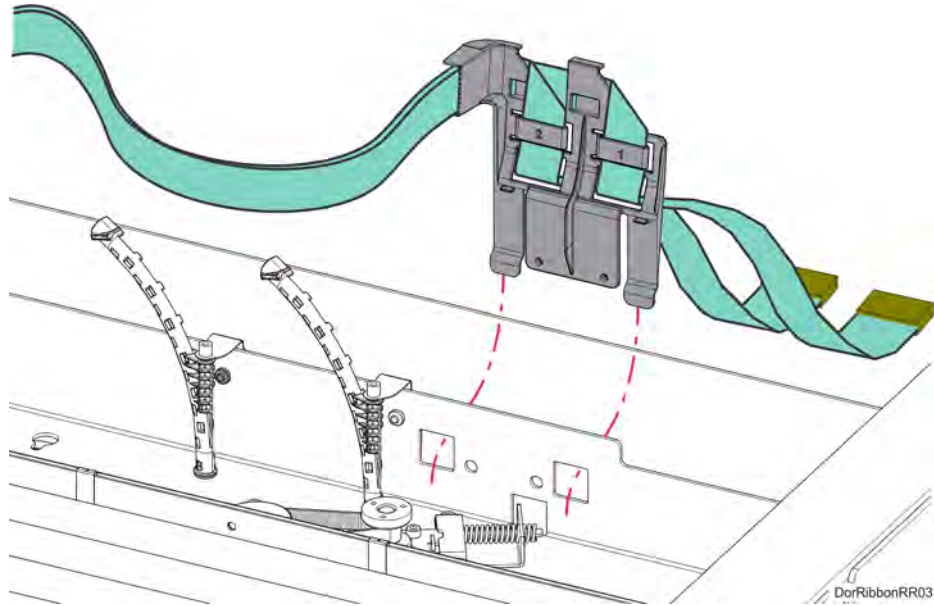

9. Remove the head ribbon cables and cable brackets from the printer. See Figure 27.

Figure 27: Head Ribbon Cables and Brackets

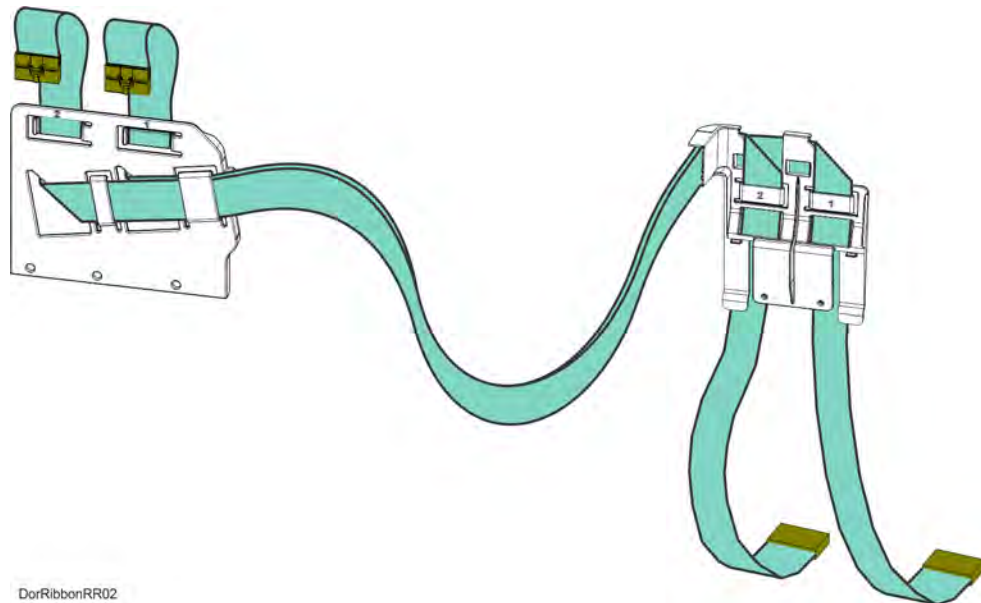

### Installing the Head Ribbon Cables

1. Install the rear ribbon cable bracket to cutouts at the back, top of the printer frame. See [Figure 26 \(page 185\)](#).
2. Using a 3 mm hex wrench install the mounting screws (3) to fasten the front ribbon cable bracket to the back of the toggle assembly. See [Figure 25 \(page 184\)](#).
3. Connect the rear head ribbon cable connectors (2) to the I/O board (J6 and J7). See [Figure 24 \(page 184\)](#).
4. Connect the front head ribbon cable connectors (2) to the material and support heads. See [Figure 24 \(page 184\)](#).
5. Install the rear panel. See “Installing the Rear Panel” (page 174).
6. Close the top cover.

## Touchscreen Display

### Required Tools

- T8 Torx wrench (included with spare part)

### Removing the Touchscreen Display

**Caution:**

The connectors and cables of the touchscreen display are fragile. Excessive force may cause damage to connector pins or wiring.

1. Power OFF the printer. See “Powering Off” (page 172).
2. Using a T8 Torx wrench, remove the mounting screws (2) that secure the touchscreen to the display housing. Retain the mounting screws. See Figure 28 (page 187).

Figure 28: Touchscreen mounting screw locations

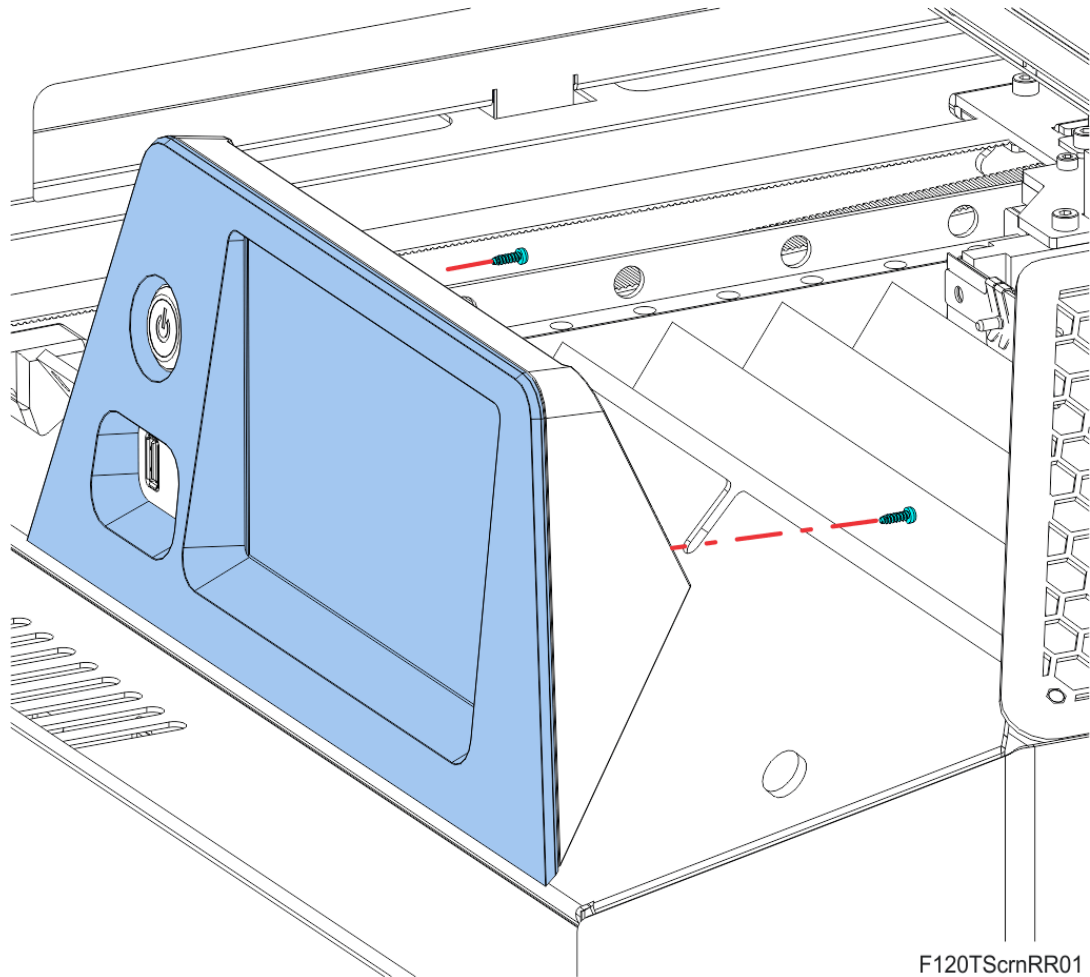

3. While supporting the touchscreen, tilt it away from the bracket to disconnect the grounding cable, touch extender cable and the flat display cable from the back of the display. Retain the nut and star washer. See Figure 29 (page 188).



**Note:**

The flat display cable connector is fragile. Simultaneously pull both corners of the connector straight out, without rocking back and forth.

4. Gently remove the touchscreen from the printer. See Figure 29 (page 188).

Figure 29: Touchscreen removal

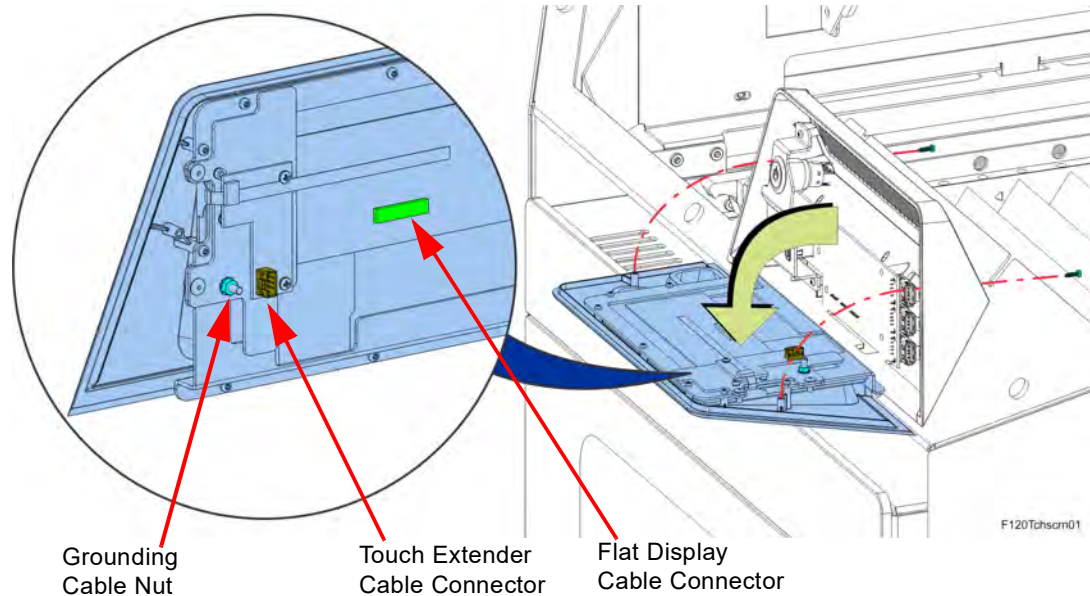

### Installing the Touchscreen Display

1. Reconnect the grounding cable, touch extender cable and the flat display cable to the back of the touchscreen display. See Figure 29 (page 188).



**Note:**

Orient the shiny side of the connector away from the display.



**Note:**

The flat display cable connector is fragile. Simultaneously push both corners of the connector straight in, without rocking back and forth.

2. Make sure that all cables are connected to the back of the touchscreen display. Tuck any excess cable behind the display.
3. Use a T8 Torx wrench, to reinstall the touchscreen mounting screws (2). See Figure 28 (page 187).



**Note:**

Touchscreen calibration should be performed after proper touchscreen operation is confirmed. See "Touchscreen Calibration" (page 85).



**Caution:**

Do not over-tighten screws inside the plastic display housing.

## Right and Left Side Oven Blowers

### Required Tools

- 2.5 mm hex wrench
- 3 mm hex wrench

### Removing the Oven Blower

1. Power OFF the printer. See “Powering OFF the Printer” (page 172).
2. Remove the rear panel. See “Removing the Rear Panel” (page 174).
3. Remove the side panels. See “Removing the Side Panels” (page 175).
4. Disconnect the oven blower motor connector from the I/O board (J39 - right blower, J37 - left blower).

**Note:**

Take note of the wire routing configuration for ease of installation.

5. Using a 3 mm hex wrench, remove the mounting screws (5) that secure the blower assembly to the oven frame, see Figure 30 (page 190).

- Remove the blower assembly from the printer. See Figure 30 (page 190).

**Note:**

Right side oven blower shown only. The left side blower procedure is identical to the right.

Figure 30: Right side blower assembly mounting screw locations

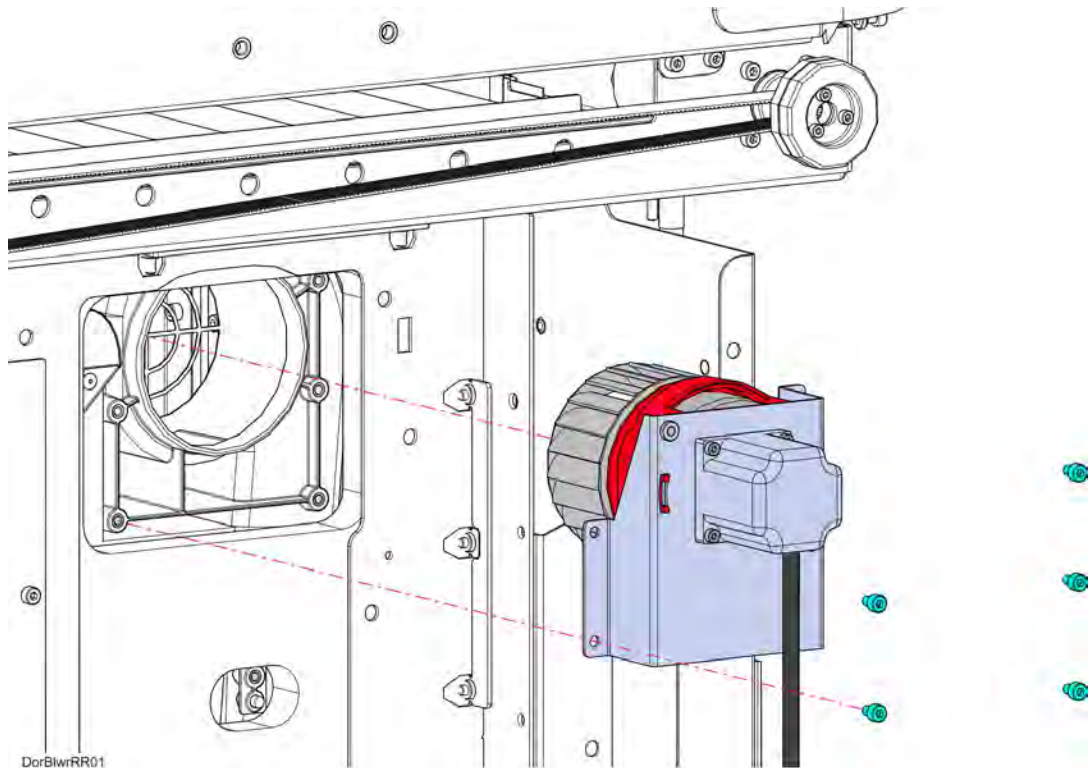

### Installing Oven Blower Assembly

- Using a 3 mm hex wrench, reinstall the blower assembly mounting screws (5). Torque to 13 in-lbs. See Figure 30 (page 190).
- Make sure the blower motor cable is routed properly and secured with tie wraps.
- Reconnect the fan blower motor cable connector to the I/O board (J39 - right blower, J37 - left blower).
- Reinstall the side panels. See “Installing the Side Panels” (page 177).
- Reinstall the rear panel. See “Installing the Rear Panel” (page 174).

## Oven Door Gasket

### Required Tools

- Screwdriver or similar instrument

### Removing the Oven Door Gasket

1. Power OFF the printer. See “Powering Off” (page 172).
2. Open the oven door.
3. Extract the gasket pins out of the holes around the entrance to the oven enclosure. See Figure 31.
4. Pull the ends of the gasket out of the hole below the entrance to the oven enclosure. See Figure 31.
5. Remove the oven gasket from the printer.

Figure 31: Oven Door Gasket Detail (door removed for clarity)

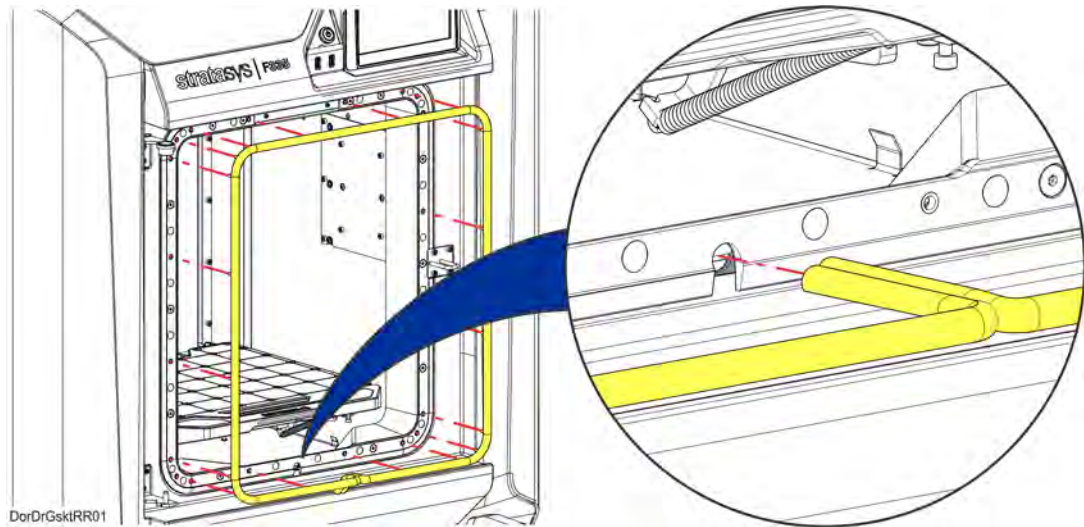

### Installing the Oven Door Gasket

1. Insert the gasket pins into the holes around the perimeter of the entrance to the oven enclosure.
2. Use a screwdriver or similar instrument to poke the ends of the gasket into the hole below the entrance to the oven enclosure.
3. Close the oven door.



## Z Drive Belt

### Required Tools

- 3 mm hex wrench
- Small flat head screwdriver

### Removing the Z Drive Belt

1. Power OFF the Printer. See “Powering Off” (page 172).
2. Remove the top cover. See “Removing the Top Cover” (page 179).
3. From inside the gantry enclosure, Use a 3 mm hex wrench to loosen the Z motor mounting screws (4). See Figure 32.

Figure 32: Z Motor Mounting Screw Locations

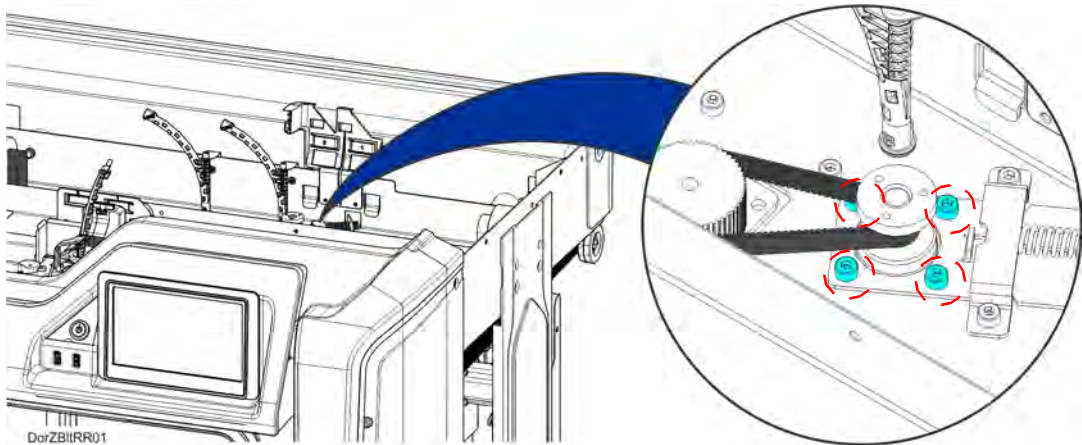

4. Using a small flat head screwdriver, relax the belt tension by gently prying the Z motor tension bracket away from the compression spring. See Figure 33.

Figure 33: Relaxing Z Belt Tension

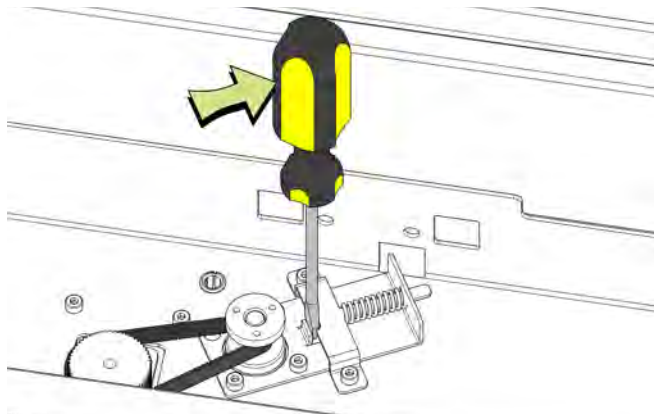

5. While the belt tension is relaxed, remove the Z drive belt from its pulleys and extract it from the printer.

### Installing the Z Drive Belt

1. Using a small flat head screwdriver, relax the belt tension by gently prying the Z motor tension bracket away from the compression spring. See [Figure 33 \(page 192\)](#).
2. Install the Z drive belt to the Z motor pulley.
3. Install the Z drive belt to the Z axis lead screw pulley.
4. Remove the flat head screwdriver from the tension bracket to restore proper tension to the Z belt.
5. Rotate the lead screw pulley two revolutions to align the Z drive belt on both pulleys.
6. Using a 3mm hex wrench, tighten the Z motor mounting screws (4). See [Figure 32 \(page 192\)](#).
7. Reinstall the top cover. See “Installing the Top Cover” (page 180).
8. Close the front top cover.

## Y Bellows

### Required Tools

- 3 mm hex wrench

### Removing the Y Bellows

1. Power OFF the printer.
2. Open the front top cover.



Move the X bridge as necessary to access Y bellows mounting clips and screws.

3. Remove the front Y bellows assembly. See [Figure 34 \(page 194\)](#).
  - a. Remove the clips (4) that secure the front bellows retainer to the front of the oven frame.
  - b. Remove the clips (4) that secure the front bellows retainer to the front of the X bridge assembly tray.
  - c. Remove the front Y bellows and retainers from the gantry enclosure.
  - d. Retain the Y bellows retainers for re-installation.
4. Remove the back Y bellows assembly. See [Figure 34 \(page 194\)](#).
  - a. Remove the clips (4) that secure the back bellows retainer to the rear of the oven frame.
  - b. Using a 3 mm hex wrench, remove the screws (3) that secure the back bellows retainer to the back of the X bridge assembly tray.
  - c. Remove the back Y bellows and retainers from the gantry enclosure.

- d. Retain the Y bellows retainers for re-installation.

Figure 34: Y Bellows Detail

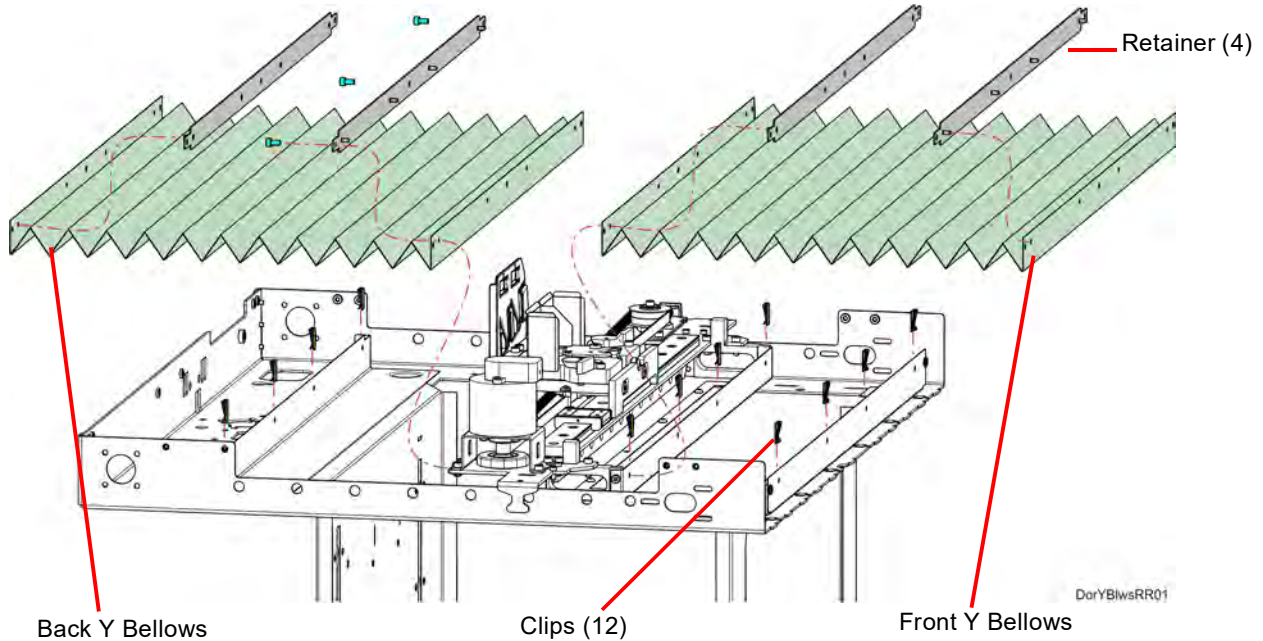

### Installing the Y Bellows

1. Transfer the Y bellows retainers to the new Y bellows.
2. Move the X bridge to the front of the gantry enclosure.
3. Install the front and rear clips (8) that secure the front Y bellows assembly to the X bridge and oven frame. See [Figure 34](#).
4. Install the rear clips (4) that secure the back Y bellows assembly to the rear of the oven frame. See [Figure 34](#).
5. Using a 3 mm hex wrench, install the screws (3) that secure the back bellows retainer to the back of the X bridge assembly tray. See [Figure 34](#).

## Oven Light

### Required Tools

- 3 mm hex wrench
- Small flathead screwdriver

### Removing the Oven Light

1. Power OFF the printer. See “Powering OFF the Printer” (page 172).
2. Open the oven door.
3. Remove the top gasket pins on both sides of the oven light above the oven enclosure. Temporarily displace the top of the oven door gasket to access the oven light.

4. From inside the front of the gantry, use a 3mm hex wrench to remove the screws (2) that secure the door box to the oven frame.

**Note:**

The door box contains cables for the oven door and camera. Gently lift and support the door box to access the oven light mounting screws underneath.

Figure 35: Door box mounting screw locations

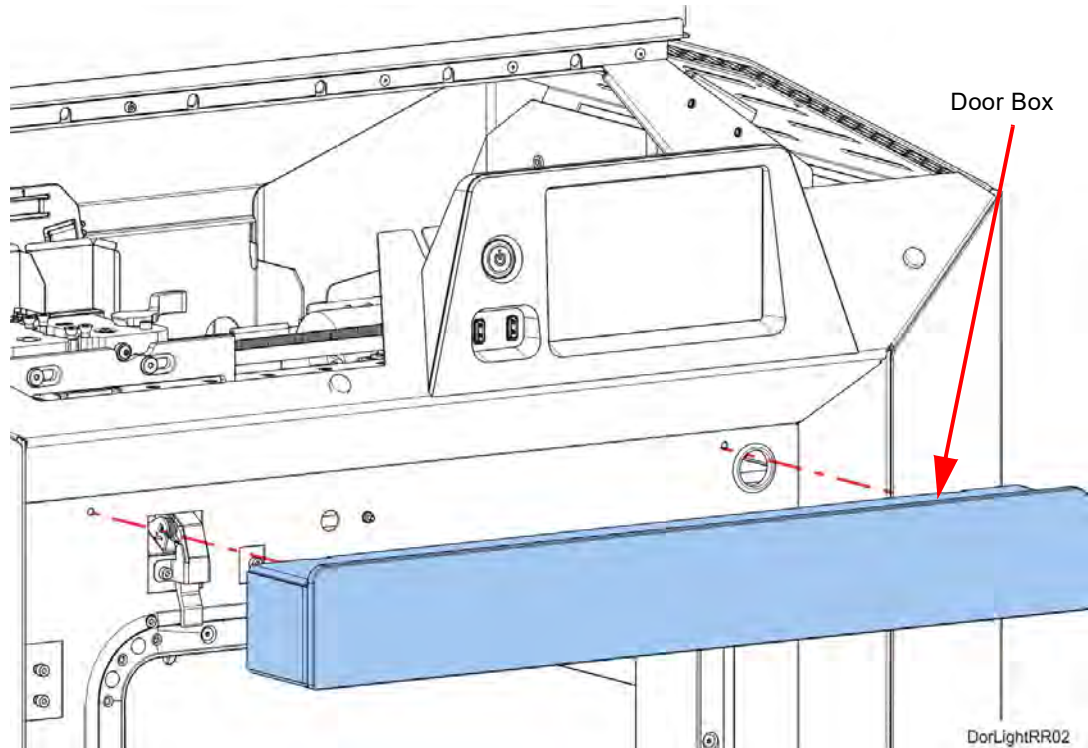

5. While supporting the door box, use a 3mm hex wrench to remove the oven light mounting screws (2) and the retaining bracket. See Figure 36 (page 196).
6. Move the oven light out a small distance to access the oven light cable connector.

7. Disconnect the oven light cable connector and remove it from the printer. If necessary, use a small flathead screwdriver to disengage the cable connector tabs. See Figure 36 (page 196).

Figure 36: Oven light detail

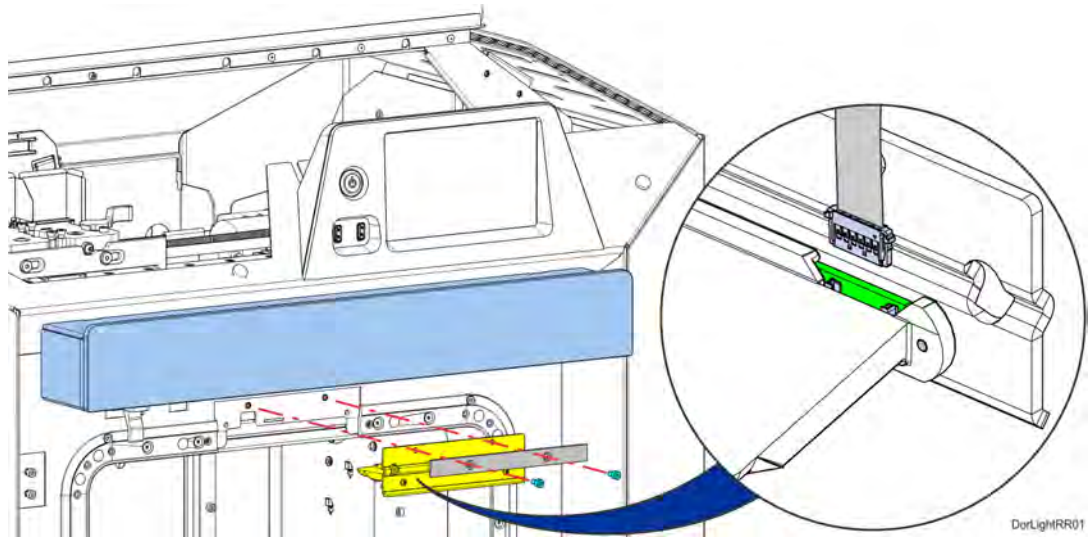

## Installing the Oven Light

1. Connect the loose cable connector to the oven light. Orient the cable with the green wire toward the center of the light. See [Figure 37 \(page 197\)](#).

Figure 37: Oven light cable detail

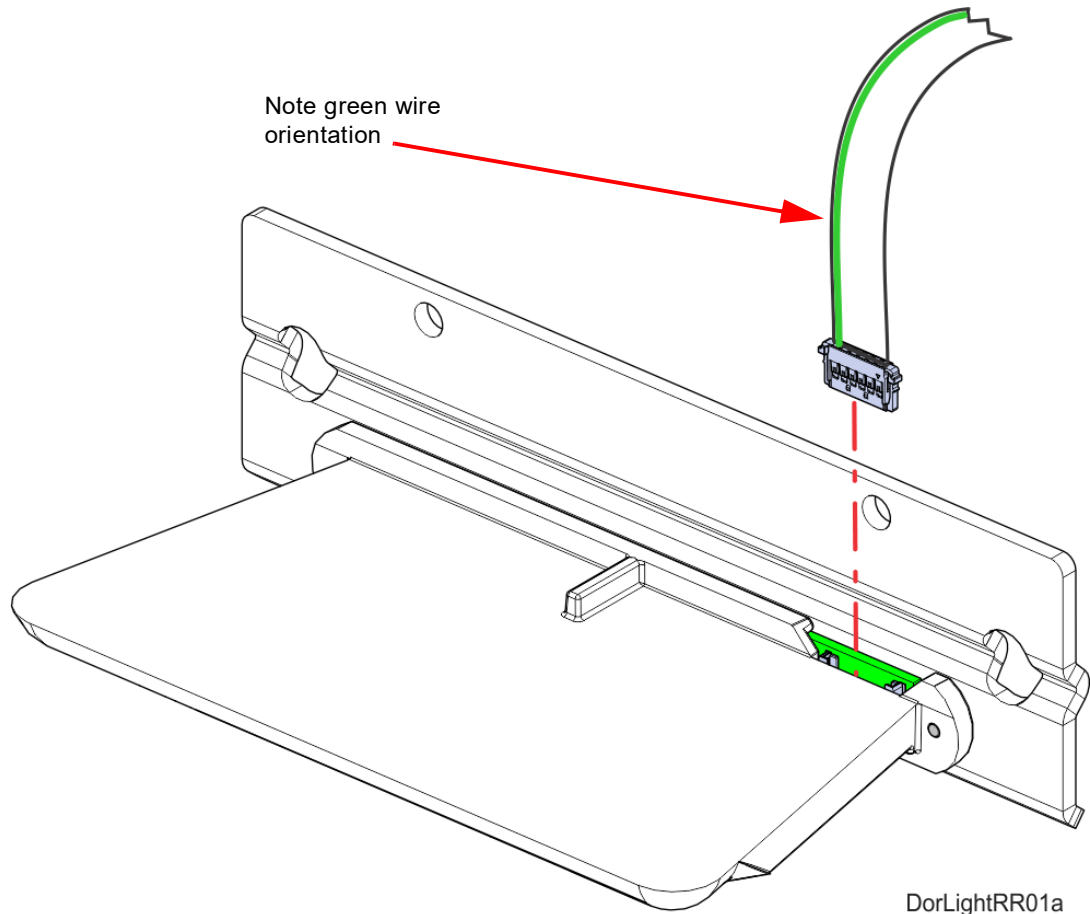

2. Tuck the excess cable into the bezel opening and push the oven light into its mounting position. If necessary, pull the cable from inside the gantry to remove slack.
3. Insert the oven light into the opening above the oven enclosure.
4. Using a 3mm hex wrench, install the retaining bracket and oven light mounting screws (2). Torque to 21 in-lbs. See [Figure 36 \(page 196\)](#).
5. From inside the front of the gantry, use a 3mm hex wrench to reinstall the screws (2) that secure the door box to the oven frame.
6. Reinstall the top gasket pins on both sides of the oven light.
7. Close the oven door.
8. Power ON the printer.

## Oven Door Camera

### Required Tools

- 3 mm hex wrench

### Removing the Oven Door Camera

**Note:**

Do not touch the camera lens. If necessary, wipe the camera lens with a clean microfiber cloth.

1. Power OFF the printer. See “Powering Off” (page 172).
2. Open the oven door.
3. Using a 3mm hex wrench, remove the camera assembly mounting screw (1) through the hole in the top of the oven door. See Figure 38 (page 198).
4. Gently move the camera assembly out a small distance and disconnect the cable on the back of the camera.
5. Remove the camera assembly from printer. See Figure 38.

Figure 38: Camera Assembly Mounting Screw Location

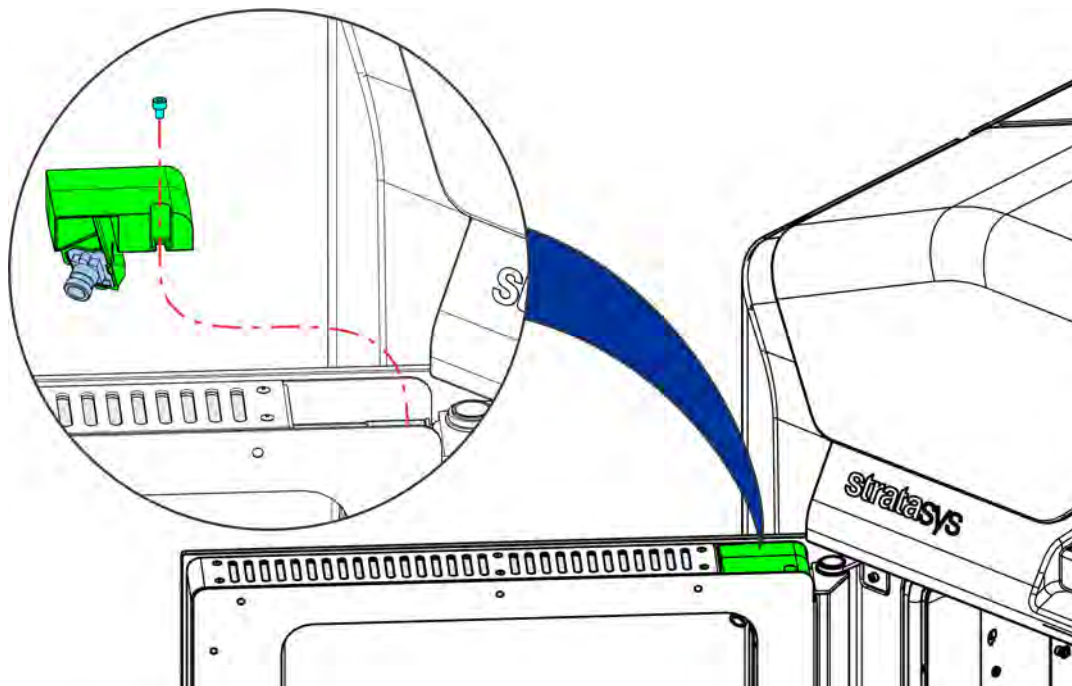

- Carefully remove the camera from the mounting bracket. Retain the mounting bracket. See Figure 39.

Figure 39: Camera Detail

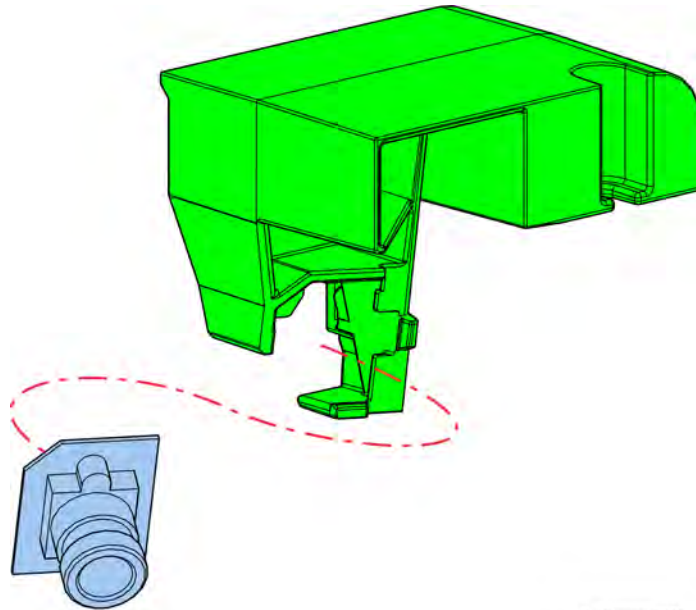

DorCameraRR02

### Installing the Oven Door Camera

**Note:**

Do not touch the camera lens. If necessary, wipe the camera lens with a clean microfiber cloth.

- Install the camera to the mounting bracket. See Figure 39 (page 199).
- Connect the camera cable to the connector on the back of the camera.
- Using a 3mm hex wrench, install the mounting screw through the hole in the top of the oven door to secure the camera assembly. See Figure 38 (page 198).

## Oven Door Latch

### Required Tools

- 2.5 mm hex wrench
- 4 mm socket wrench

### Removing the Oven Door Latch

- Power off the printer. See “Powering Off” (page 172).
- Open the oven door.
- Using a 2.5 mm hex wrench, remove the inside door panel mounting screws (11). See Figure 40.



- Pivot and remove the inside door panel from the door assembly. Gently press on the pivot arms to disengage them from the door assembly. See Figure 40.

Figure 40: Inside door panel mounting screw locations

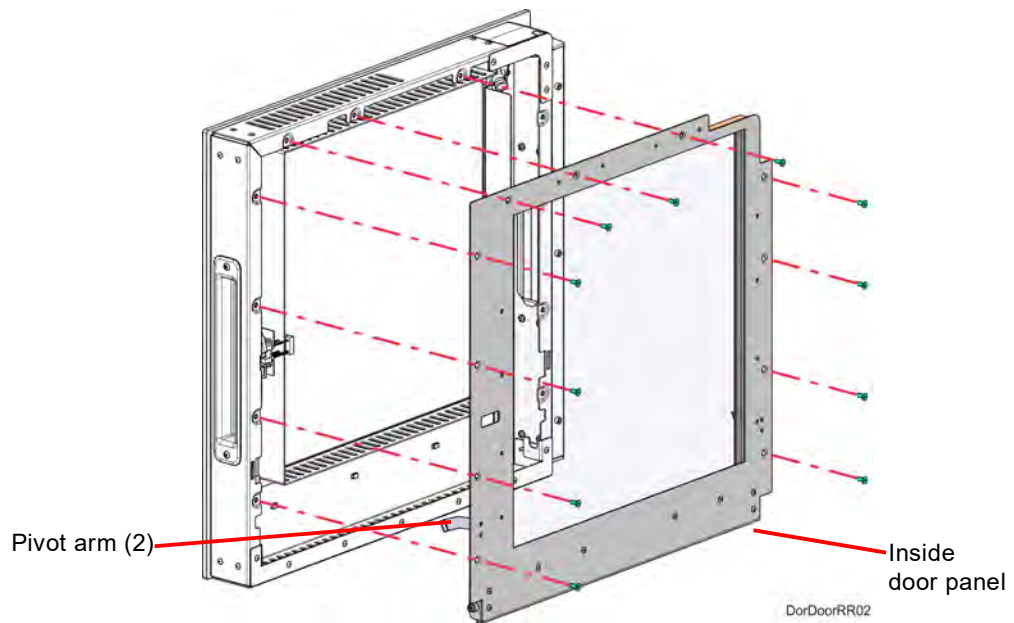

- Disconnect the door latch assembly solenoid cable connector.
- Disconnect the door latch assembly sensor cable connectors (2).
- Using a 4 mm socket wrench, remove the door latch assembly mounting nuts (2). See Figure 41.
- Remove the door latch assembly from the oven door. See Figure 41.

Figure 41: Door latch assembly mounting nut locations

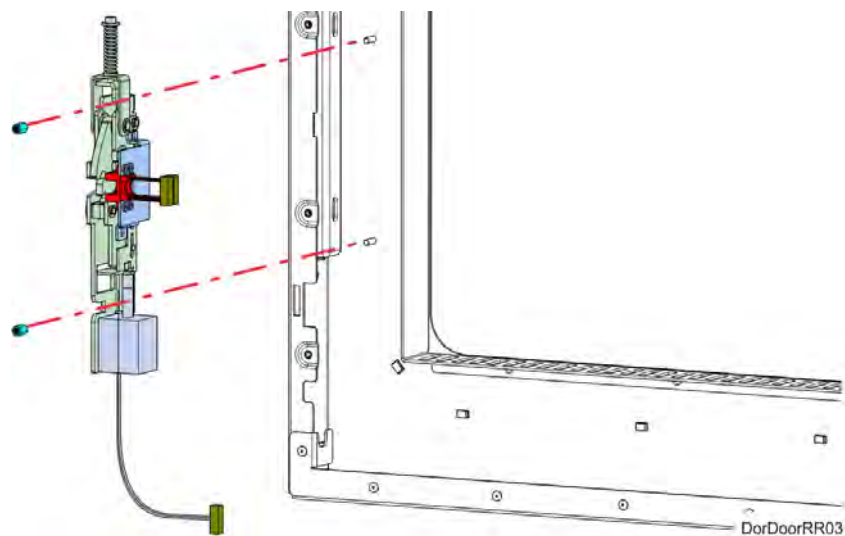

9. Using a 2.5 mm hex wrench, remove the sensor bracket mounting screws (2). See Figure 42.
10. Remove the sensor and bracket from the latch assembly and retain them for re-installation. See Figure 42.

Figure 42: Door latch sensor mounting bracket detail

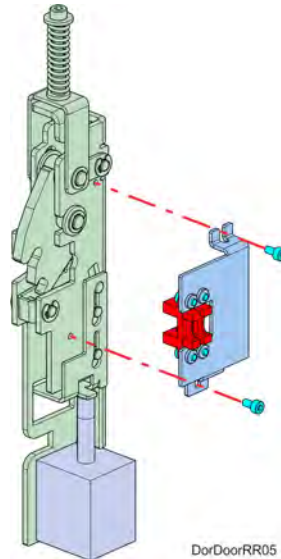

### Installing the Oven Door Latch

1. Using a 2.5 mm hex wrench, install the sensor bracket mounting screws (2) to secure the sensor mounting bracket to the oven door latch assembly. See Figure 42 (page 201).
2. Using a 4 mm socket wrench, install the door latch assembly mounting nuts (2) to secure the door latch assembly inside the oven door assembly. See Figure 41 (page 200).
3. Connect the door latch assembly sensor cable connectors (2).
4. Install the inside door panel into the door assembly. See Figure 43.
  - a. Angle the inside door panel slightly and insert the pivot nuts into the lower notches on both sides of the door frame.
  - b. Gently press down on the door panel until the pivot nuts are fully seated inside the door frame.
  - c. Rotate the top of door panel toward the door assembly. Gently press in the pivot arms to insert them into the upper notches on both sides of the door frame.

- d. Close the door panel and make sure that the panel and frame mounting holes are aligned.

Figure 43: Inside oven door panel detail

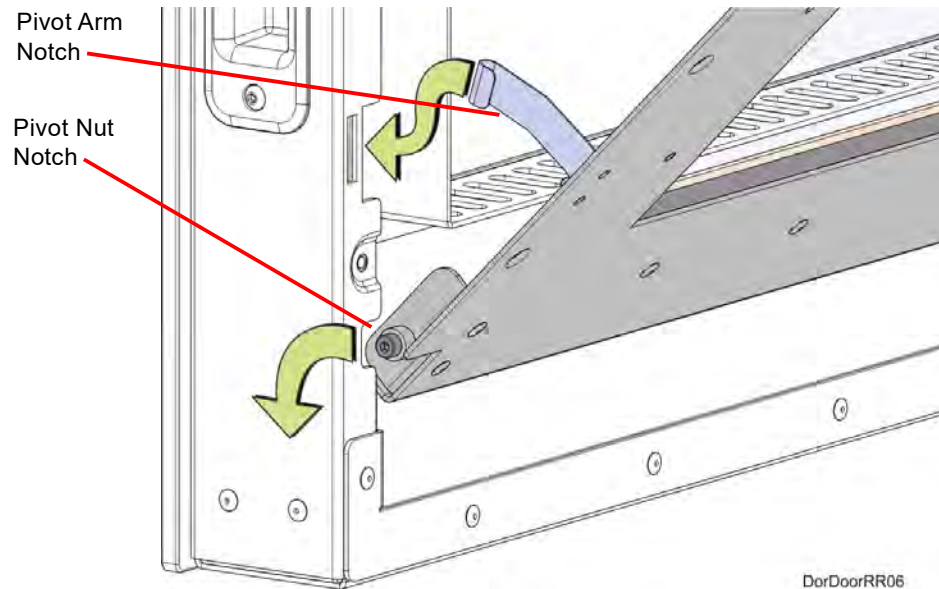

5. Using a 2.5 mm hex wrench, install the inside door panel mounting screws (11). See Figure 40 (page 200).
6. Close the oven door.

## Top Cover Interlock Sensor and Actuator

### Required Tools

- 2 mm hex wrench
- 2.5 mm hex wrench

### Removing Top Cover Interlock Sensor

1. Power OFF the printer. See “Powering Off” (page 172).
2. Open the front top cover.
3. Disconnect the top cover sensor cable at the quick disconnect.
4. Remove the three cable ties that secure the cable to the sensor mounting bracket.
5. Use a 2 mm hex wrench to remove the sensor mounting screws (2). See Figure 44.
6. Remove the top cover sensor from the mounting bracket.

Figure 44: Top Cover Sensor Mounting Screw Locations

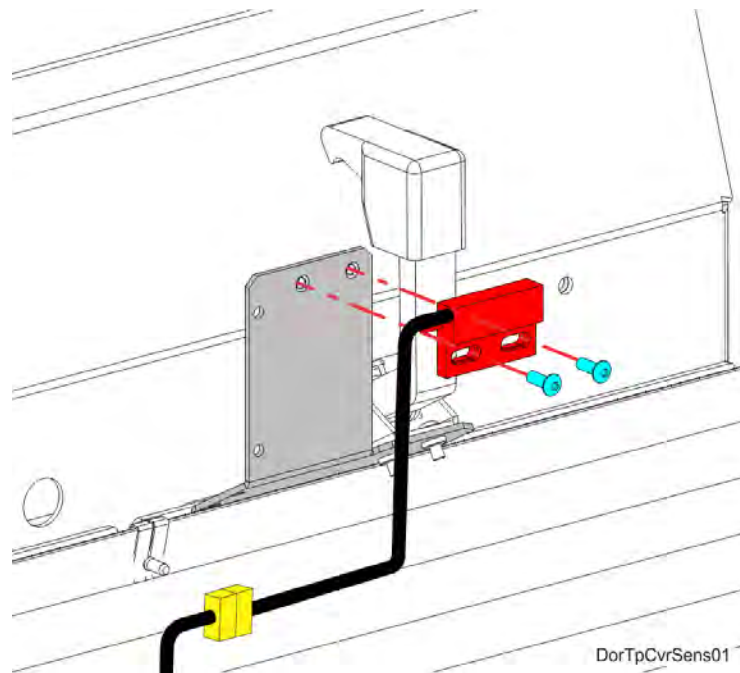

7. Use a 2.5 mm hex wrench to remove the top cover actuator mounting screws (2). See Figure 45 (page 204).

- Remove the top cover actuator.

Figure 45: Top Cover Actuator Mounting Screw Locations

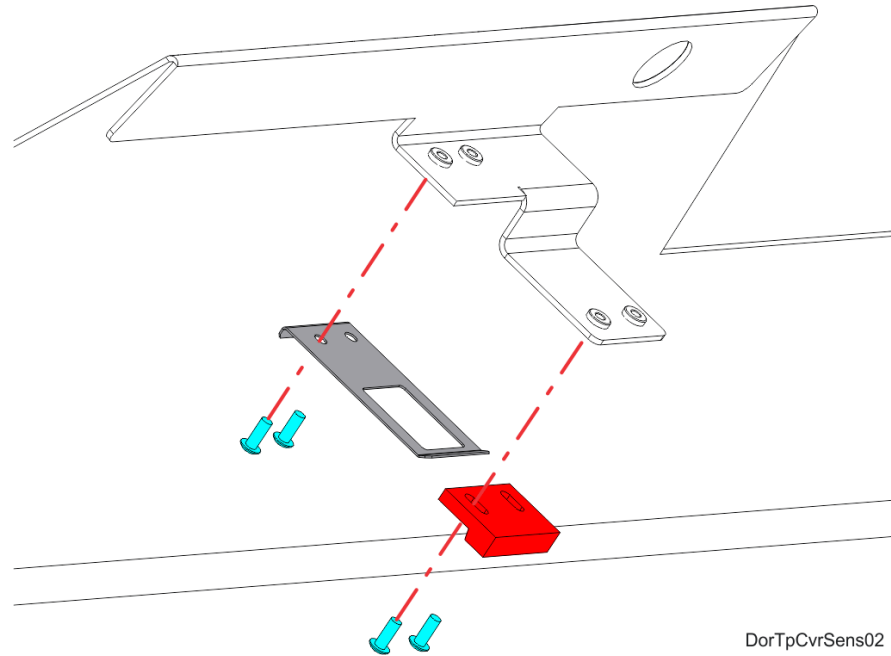

### Installing the Top Cover Interlock Sensor

- Use a 2 mm hex wrench to reinstall the mounting screws (2) that secure the interlock sensor to the mounting bracket. See [Figure 44](#) (page 203).
- Reconnect the top cover sensor cable at the quick disconnect connector.
- Install three cable ties to secure the sensor cable to the mounting bracket.
- Use a 2.5 mm hex wrench to reinstall the mounting screws (2) that secure the interlock actuator to the top cover. See [Figure 45](#).
- Close the top cover.
- Power ON the printer.
- Verify operation by opening and closing the top cover.
- If the touchscreen displays errors indicating that the cover is not closed, adjust the position of the actuator.

# 8 TROUBLESHOOTING

This chapter describes troubleshooting steps that can be performed to correct basic problems with the F120 printer.

## Getting Help

If you have a problem with your printer or the printer's materials that is not covered in this guide, or if you need to order replacement parts, please contact Customer Support for your region. Contact information is available from the Stratasys website at: <http://www.stratasys.com/customer-support/contact-customer-support>.

If needed, you can write to Customer Support North America at:

Stratasys, Inc.  
Customer Support  
7665 Commerce Way  
Eden Prairie, MN 55344 USA

Before calling for service or supplies, always have the following information ready:

- Your printer's software version (see "Software Version" (page 131) for instructions on obtaining this information).
- Your printer's serial number (see Figure 3 (page 9) or "System Odometers" (page 88) for information on locating the printer's serial number).
- Access to your GrabCAD Print workstation in order to provide a configuration file, if necessary (see "Exporting System Configuration (.CFG) File" (page 162) for instructions on obtaining this information).

## Warnings and Errors

If the printer detects an issue that may affect a build, it will be indicated within the Notifications Display portion of the "Build Page" (page 36). A yellow or red notification badge icon will be displayed, depending on the severity of the warning/error, along with text indicating the reason(s) for the warning. Touching the text on the screen will open a dialog indicating the reason(s) for the notification, and in some cases, steps to correct the notification (see Figure 4 (page 36)).

Depending on the type of warning/error, a notification badge icon may also be displayed within the "Materials Page" (page 53). The Materials button will be displayed in its warning state within the Navigation Menu to indicate the warning (see Table 1 (page 34)). Within the Materials page a notification badge icon will be displayed over the center of the Material Status Icon experiencing the warning/ error (see Table 7 (page 60)). Touching the notification badge icon on the screen will open the corresponding material's Materials Details page and provide information indicating the cause of a warning/error (see Figure 29 (page 62)).

## Warnings at Build Start

### **Model material does not match selected job**

- The model material currently installed does not match the model material configuration of the selected job.
- Correct condition - unload incorrect model material and load the correct model material for the selected job. See [“Unloading Material” \(page 108\)](#) and [“Loading Material” \(page 100\)](#) for instructions.

### **Support material does not match selected job**

- The support material currently installed does not match the support material configuration of the selected job.
- Correct condition - unload incorrect support material and load the correct support material for the selected job. See [“Unloading Material” \(page 108\)](#) and [“Loading Material” \(page 100\)](#) for instructions.

### **Insufficient model material for part build**

- The amount of model material currently installed in the printer is not sufficient for the selected build.
- Correct condition - connect a material coil box to the printer that contains a sufficient amount of model material. See [“Loading Material” \(page 100\)](#) for instructions.

### **Insufficient support material for part build**

- The amount of support material currently installed in the printer is not sufficient for the selected build.
- Correct condition - connect a material coil box to the printer that contains a sufficient amount of support material. See [“Loading Material” \(page 100\)](#) for instructions.

### **Order new model head**

- The model head has reached 1350 build hours, and is near its odometer limit. Build hours are available within the head's Head Details page (see [“Viewing Head Details” \(page 56\)](#)).
- Correct condition - you are still able to build using this head, but part quality may be affected. Once the head's odometer limit is reached, you will be prompted to change the head (see [“Head Replacement” \(page 111\)](#)).

### **Order new support head**

- The support head has reached 1350 build hours, and is near its odometer limit. Build hours are available within the head's Head Details page (see [“Viewing Head Details” \(page 56\)](#)).
- Correct condition - you are still able to build using this head, but part quality may be affected. Once the head's odometer limit is reached, you will be prompted to change the head (see [“Head Replacement” \(page 111\)](#)).

### **Replace model head**

- The model head has reached 1500 build hours (odometer limit). Build hours are available within the head's Head Details page (see [“Viewing Head Details” \(page 56\)](#)).

- Correct condition - you are able to continue building using this head but it is recommended that you change the head prior to starting a new build (see [“Head Replacement”](#) (page 111)).

**Replace support head**

- The support head has reached 1500 build hours (odometer limit). Build hours are available within the head’s Head Details page (see [“Viewing Head Details”](#) (page 56)).
- Correct condition - you are able to continue building using this head but it is recommended that you change the head prior to starting a new build (see [“Head Replacement”](#) (page 111)).

## Errors Preventing a Build from Starting

**Printer busy**

- Indicates that the printer is in the process of completing another task and a build cannot be started until the task is complete.
- Correct condition - wait a couple of minutes and then attempt to restart the build.

**Close the door**

- Indicates that the oven door is open.
- Correct condition - close the oven door.

**Close the cover**

- Indicates that the top cover is open.
- Correct condition - close the top cover.

**Remove the part**

- Indicates that the completed part from the previously built job is still in the printer’s oven chamber.
- Correct condition - open the oven door and remove the completed part. See [“Removing a Part from the Printer”](#) (page 122) for instructions.

**Select a job**

- Indicates that a job has not been selected for building.
- Correct condition - select the job you’d like to build from the Job Queue. See [“Selecting a Job to Build”](#) (page 115) for instructions.

**Insert a model head**

- Indicates that a model head has not been installed into the printer.
- Correct condition - install model head. See [“Head Replacement”](#) (page 111) for instructions.



**Insert a support head**

- Indicates that a support head has not been installed into the printer.
- Correct condition - install support head. See “[Head Replacement](#)” (page 111) for instructions.

**Model head not communicating**

- Indicates that model head is not enabled/communicating. This will only be displayed when the top cover is closed.
- Correct condition - open the top cover and unclip the head cable from the model head. Wait a few seconds and then reconnect the head cable to the model head and close the top cover (see “[Head Replacement](#)” (page 111) for details). If the error persists there is likely a problem with either the head or the head cable; please contact Stratasys Customer Support or your regional Stratasys office for further assistance (see “[Getting Help](#)” (page 205) for contact information).

**Support head not communicating**

- Indicates that support head is not enabled/communicating. This will only be displayed when the top cover is closed.
- Correct condition - open the top cover and unclip the head cable from the support head. Wait a few seconds and then reconnect the head cable to the support head and close the top cover (see “[Head Replacement](#)” (page 111) for details). If the error persists there is likely a problem with either the head or the head cable; please contact Stratasys Customer Support or your regional Stratasys office for further assistance (see “[Getting Help](#)” (page 205) for contact information).

**Model head not initialized**

- Indicates that head data is not ready. This is only displayed when the printer is initializing a newly installed head, or if the initialization process failed.
- Correct condition - wait at least 60 seconds after the error is first displayed. If the error persists, open the top cover and unclip the head cable from the model head. Wait a few seconds and then reconnect the head cable to the model head and close the top cover (see “[Head Replacement](#)” (page 111) for details). If the error persists there is likely a problem with either the head or the head cable; please contact Stratasys Customer Support or your regional Stratasys office for further assistance (see “[Getting Help](#)” (page 205) for contact information).

**Support head not initialized**

- Indicates that head data is not ready. This is only displayed when the printer is initializing a newly installed head, or if the initialization process failed.
- Correct condition - wait at least 60 seconds after the error is first displayed. If the error persists, open the top cover and unclip the head cable from the support head. Wait a few seconds and then reconnect the head cable to the support head and close the top cover (see “[Head Replacement](#)” (page 111) for details). If the error persists there is likely a problem with either the head or the head cable; please contact Stratasys Customer Support or your regional Stratasys office for further assistance (see “[Getting Help](#)” (page 205) for contact information).

**Load model material**

- Indicates that model material has not been loaded into the printer.
- Correct condition - load model material. See [“Loading Material” \(page 100\)](#) for instructions.

**Load support material**

- Indicates that support material has not been loaded into the printer.
- Correct condition - load support material. See [“Loading Material” \(page 100\)](#) for instructions.

**Replace invalid model spool**

- Indicates that the material coil box is invalid. Invalid materials are materials not licensed or not compatible with the associated head type.
- Correct condition - disconnect the invalid material coil box and replace it with a valid material coil box. See [“Unloading Material” \(page 108\)](#) and [“Connecting Material Coil Box To Printer” \(page 101\)](#) for instructions.

**Replace invalid support spool**

- Indicates that the material coil box is invalid. Invalid materials are materials not licensed or not compatible with the associated head type.
- Correct condition - disconnect the invalid material coil box and replace it with a valid material coil box. See [“Unloading Material” \(page 108\)](#) and [“Connecting Material Coil Box To Printer” \(page 101\)](#) for instructions.

**Replace empty model spool**

- Indicates that the material coil box has run out of material.
- Correct condition - disconnect the empty material coil box and replace with a new material coil box. See [“Unloading Material” \(page 108\)](#) and [“Connecting Material Coil Box To Printer” \(page 101\)](#) for instructions.

**Replace empty support spool**

- Indicates that the material coil box has run out of material.
- Correct condition - remove the empty material coil box and replace with a new material coil box. See [“Unloading Material” \(page 108\)](#) and [“Connecting Material Coil Box To Printer” \(page 101\)](#) for instructions.

## Load/Unload Errors

**Timed out**

- Indicates that filament was not detected at the head within 5 minutes of a load’s initiation.
- Correct condition - disconnect the material coil box and ensure that it is properly prepared for installation and load. See [“Material Coil Box Preparation” \(page 100\)](#) and [“Connecting Material Coil Box To Printer” \(page 101\)](#) for details. reconnect the material coil box (see [“Loading Material” \(page 100\)](#)).

**Purge failed**

- Indicates that filament is currently in the head, but the load failed.

- Correct condition - unload model and support material (see “Unloading Material” (page 108)) and then reload these materials (see “Loading Material” (page 100)). Once loaded, verify that material purges from the tips by performing a manual purge of each tip using the purge buttons within the Tip Maintenance page (see “Head Maintenance” (page 57)).

**Resource not available**

- Indicates that the printer is in the process of completing another task and a load/unload cannot be started until the task is complete.
- Correct condition - wait a couple of minutes and then attempt to load/unload material.

**Task already running**

- Indicates that the printer is in the process of loading or unloading material. Only one material coil box can be loaded or unloaded at a time.
- Correct condition - wait until the load/unload in process is complete before attempting to load material to or unload material.

**Invalid material**

- Indicates that the installed material is not licensed for use with the printer.
- Correct condition - to adjust your printer's material license please contact Stratasys Customer Support or your regional Stratasys office (see "Getting Help" (page 205) for contact information).

**Cannot load model in to support head**

- Indicates that you have inserted a model material coil box's filament key into the wrong filament port in the printer.
- Correct condition - Remove the material key from its current location and insert it into the upper filament port. See Figure 11 (page 26) for details.

**Cannot load support in to model head**

- Indicates that you have installed a support material coil box's filament key into the wrong filament port in the printer.
- Correct condition - Remove the material key from its current location and insert it into the lower filament port. See Figure 11 (page 26) for details.

**Cannot change material type during build**

- Indicates that the printer is currently in the process of building and you are attempting to change model or support material during the build.
- Correct condition - you cannot change material types while the printer is in the process of building a part. Wait until the build is complete before changing materials.

## Build Pause Warnings



Any pause not initiated by the operator will display a warning which must be acknowledged on the User Interface before the printer can resume building.

**User requested**

- Indicates that a pause was initiated by the operator or inserted within the job's file.
- Correct condition - resume the build by pressing the **Play** button within the Build page (see Table 3 (page 44) for button details).

**Out of model material**

- The printer has run out of model material.
- Correct condition - disconnect the empty material coil box and replace as needed. See "Unloading Material" (page 108) and "Connecting Material Coil Box To Printer" (page 101) for instructions.

**Out of support material**

- The printer has run out of support material.
- Correct condition - disconnect the empty material coil box and replace as needed. See "Unloading Material" (page 108) and "Connecting Material Coil Box To Printer" (page 101) for instructions.

**Active model spool removed**

- Indicates that the printer lost contact with the model material coil box's memory chip.
- Correct condition - ensure that the filament key is seated correctly within its filament port. If so, disconnect and then reconnect the material coil box (see [“Unloading Material” \(page 108\)](#) and [“Connecting Material Coil Box To Printer” \(page 101\)](#)). If this does not correct the error, disconnect the current material coil box and connect a new one.

**Active support spool removed**

- Indicates that the printer lost contact with the support material coil box's memory chip.
- Correct condition - ensure that the filament key is seated correctly within its filament port. If so, disconnect and then reconnect the material coil box (see [“Unloading Material” \(page 108\)](#) and [“Connecting Material Coil Box To Printer” \(page 101\)](#)). If this does not correct the error, disconnect the current material coil box and connect a new one.

**Model head removed**

- Indicates that the printer lost contact with the model head.
- Correct condition - ensure that the head is seated correctly within the gantry. If so, remove the head and then reinstall it (see [“Head Replacement” \(page 111\)](#)). If this does not correct the error, remove the head and install a new head.

**Support head removed**

- Indicates that the printer lost contact with the support head.
- Correct condition - ensure that the head is seated correctly within the gantry. If so, remove the head and then reinstall it (see [“Head Replacement” \(page 111\)](#)). If this does not correct the error, remove the head and install a new head.

## Build Abort Errors



All abort related errors must be acknowledged on the User Interface before the printer is put into an aborted state.

### **Aborted by user**

- Indicates that the abort was initiated by the operator.
- Correct condition - remove the aborted build from the printer, see “Removing a Part from the Printer” (page 122) for instructions.

### **Failed to find Z zero**

- Indicates that the Z stage failed to find its home position.
- Correct condition - verify that there is nothing obstructing the calibration targets on the platen, see “Cleaning the Platen” (page 167) for instructions.

### **Failed to process the part**

- An error occurred when attempting to translate the CMB file into commands for the printer.
- Correct condition - often the result of a corrupted or outdated CMB file. Ensure that your printer’s software version is up to date (see “Updating Controller Software” (page 158)) and that you are using the correct version of GrabCAD Print software. Reprocess, reorient, and resend the job file to the printer using GrabCAD Print (see “GrabCAD Print Software” (page 32)) and then restart the build (see “Basic Job Build Tasks” (page 113) for instructions).

### **Failed to load toolpaths**

- Printer unexpectedly lost job information during the build.
- Correct condition - reprocess, reorient, and resend the job file to the printer using GrabCAD Print (see “GrabCAD Print Software” (page 32)). If you encounter the same error when rebuilding with the reprocessed file, attempt to build a different file to see if the error occurs again. If so, contact Stratasys Customer Support or your regional Stratasys office (see “Getting Help” (page 205) for contact information).

### **Failed to calibrate tip offsets**

- Indicates that the printer failed to calibrate tip offsets.
- Correct condition - perform an automatic tip calibration (“Automatic Tip Calibration” (page 141)). If calibration fails, perform a manual tip calibration (“Manual Tip Calibration” (page 144)). If calibration fails again, contact Stratasys Customer Support or your regional Stratasys office (see “Getting Help” (page 205) for contact information).

### **Active spool removed**

- Indicates that the active material coil box was disconnected. This is only displayed when the printer is preparing for a build.
- Correct condition - install a material coil box and load model material. See “Connecting Material Coil Box To Printer” (page 101) and “Loading Material” (page 100) for instructions.

**Model head removed**

- Indicates that the printer lost contact with the model head.
- Correct condition - ensure that the head is seated correctly within the gantry. If so, remove the head and then reinstall it. If this does not correct the error, remove the head and install a new head.

**Support head removed**

- Indicates that the printer lost contact with the support head.
- Correct condition - ensure that the head is seated correctly within the gantry. If so, remove the head and then reinstall it. If this does not correct the error, remove the head and install a new head.

**File not found**

- Indicates that the printer was unable to locate the job file that was selected for building. This error pertains to job files loaded via USB flash drive only.
- Correct condition - ensure that the USB flash drive containing the selected job file is securely inserted into one of the USB ports within the interface panel (see [Figure 3 \(page 19\)](#) for port locations). Once the flash drive is securely inserted into one of the printer's USB ports select the file you'd like to build by loading it to the Job Queue (see ["USB Method" \(page 46\)](#)).

**Unknown error**

- An unexpected error occurred in which the printer was unable to map the cause of the error to a known abort reason.
- Correct condition - attempt to restart the build, see ["Basic Job Build Tasks" \(page 113\)](#) for instructions. If the error persists, contact Stratasys Customer Support or your regional Stratasys office (see ["Getting Help" \(page 205\)](#) for contact information).



The warnings and errors listed below are displayed within the notifications area of the Head Details page. See ["Viewing Head Details" \(page 56\)](#) for details.



## Head Warnings

### **Not initialized**

- Indicates that head data is not ready. This is only displayed when the printer is initializing a newly installed head, or if the initialization process failed.
- Correct condition - wait at least 60 seconds after the error is first displayed. If the error persists, open the top cover and unclip the head cable connected to the corresponding head. Wait a few seconds and then reconnect the head cable to the head and close the top cover (see [“Head Replacement” \(page 111\)](#) for details). If the error persists there is likely a problem with either the head or the head cable; please contact Stratasys Customer Support or your regional Stratasys office for further assistance (see [“Getting Help” \(page 205\)](#) for contact information).

### **Order new model head**

- Indicates that the model head is near its odometer limit. This warning is displayed as a reminder to order a replacement head for the one that is approaching its odometer limit. Build hours are available within the head’s Head Details page (see [“Viewing Head Details” \(page 56\)](#)).
- Correct condition - you are still able to build using this head, but part quality may be affected. Once the head’s odometer limit is reached, you will be prompted to change the head (see [“Head Replacement” \(page 111\)](#)).

### **Order new support head**

- Indicates that the support head is near its odometer limit. This warning is displayed as a reminder to order a replacement head for the one that is approaching its odometer limit. Build hours are available within the head’s Head Details page (see [“Viewing Head Details” \(page 56\)](#)).
- Correct condition - you are still able to build using this head, but part quality may be affected. Once the head’s odometer limit is reached, you will be prompted to change the head (see [“Head Replacement” \(page 111\)](#)).

## Head Errors

### **Replace model head**

- Indicates that the model head has reached its build hour odometer limit. This error message is displayed as a reminder that you should replace the head before starting another build. Build hours are available within the head’s Head Details page (see [“Viewing Head Details” \(page 56\)](#)).
- Correct condition - you are able to continue building using this head but it is recommended that you change the head prior to starting a new build (see [“Head Replacement” \(page 111\)](#)).

**Replace support head**

- Indicates that the support head has reached its build hour odometer limit. This error message is displayed as a reminder that you should replace the head before starting another build. Build hours are available within the head’s Head Details page (see “[Viewing Head Details](#)” (page 56)).
- Correct condition - you are able to continue building using this head but it is recommended that you change the head prior to starting a new build (see “[Head Replacement](#)” (page 111)).

## Finding a Remedy

The following table lists various troubleshooting scenarios you may encounter when operating the printer and methods for resolving these scenarios.

Condition	Possible Cause	Remedy
Material will not load	Empty material coil box (zero volume).	disconnect and replace the empty material coil box (see “ <a href="#">Handling/Storing Materials</a> ” (page 111) and “ <a href="#">Connecting Material Coil Box To Printer</a> ” (page 101)).
	Incorrect material coil box connected.	The F120 uses a different material coil box memory chip than other Stratasys printers. As a result, only F120 material coil boxes can be used to build parts on the printer. Ensure that an F120 material coil box is installed.
	Material coil box memory chip circuit failed.	View the material coil box’s associated Material Status Icon within the Materials page. If the icon is red, there may be an issue with the material coil box’s memory chip. Disconnect and then reconnect the material coil box. If the error persists, replace the material coil box with a new one. See “ <a href="#">Unloading Material</a> ” (page 108), “ <a href="#">Handling/Storing Materials</a> ” (page 111), and “ <a href="#">Loading Material</a> ” (page 100).
	Filament does not reach head (load time-out reached)	Disconnect the material coil box and replace with a new box (see “ <a href="#">Handling/Storing Materials</a> ” (page 111) and “ <a href="#">Loading Material</a> ” (page 100)). If the error persists, contact Customer Support or your regional Stratasys office (see “ <a href="#">Getting Help</a> ” (page 205) for contact information).

Condition	Possible Cause	Remedy
System paused with <b>No material detected at head</b> error	Material spinout	Unload and reload material. See “Unloading Material” (page 108) and “Loading Material” (page 100).
	Material coil box is cross-wound	Pull material from the material coil box until the point where the cross-winding is reached. Re-load material. See “Loading Material” (page 100).
	Calibration performed incorrectly	Perform an “Automatic Tip Calibration” (page 141). Next perform a “Manual Tip Calibration” (page 144). Enter the results using the touch screen GUI.
	Broken material clogging filament tube	Locate broken material by manually feeding material to the head from the material port.
	Confirm the blue elbow of the material tube is properly seated	If elbow is not properly seated, call reseller to order the bracket designed to prevent this issue.
Loss of extrusion (head will not extrude material)	Plugged Tips	Verify that material purges by initiating a purge using the model and/or support purge buttons. See “Head Maintenance” (page 57). Replace head with new head and recalibrate. See “Head Replacement” (page 111).
	Printer not calibrated	Perform a Tip Offset Calibration. See “Tip Calibration” (page 140).
Support material is difficult to remove from part	Support material is embedded in the vertical surfaces of the part.	Adjust the Tip Offset Calibration. See “Manual Tip Calibration” (page 144).
Model material surface finish is poor on downward facing surfaces Support material removes too easily	The tip to tip calibration is not set correctly.	Repeat Tip Offset Calibration. See “Manual Tip Calibration” (page 144).
Material oozing	Moisture in the material coil box.	Contact Customer Support or your regional Stratasys office (see “Getting Help” (page 205) for contact information).

Condition	Possible Cause	Remedy
Oven not maintaining temperatures	Heater failure.	Contact Customer Support or your regional Stratasys office (see “Getting Help” (page 205) for contact information).
	Oven door open.	Close the oven door; the heater turns off while the door is open.
	Oven door not sealing.	Check oven door seal and verify that it is securely affixed to oven door frame and does not exhibit cuts/tears. If excessive wear is visible, Contact Customer Support or your regional Stratasys office (see “Getting Help” (page 205) for contact information).

# 9 SUPPLEMENTARY INFO

## Declaration of Conformity

Declaration of Conformity information is available from your Stratasys representative. Please contact your local regional office for a copy of this document.

## Regulatory and Environmental Information

### EMC Class A Warning

**Warning:**

This is a Class A product. In a domestic environment this product may cause radio interference in which case the user may be required to take adequate measures.

### FCC Statements (U.S.A.)

The U.S. Federal Communications Commission (in 47 cfr1 5.105) has specified that the following notices be brought to the attention of users of this product.

This device complies with part 15 of the FCC rules. Operation is subject to the following two conditions: (1) this device may not cause harmful interference, and (2) this device must accept any interference received, including interference that may cause undesired operation.

**Caution:**

Pursuant to Part 15.21 of the FCC Rules, any changes or modifications to this equipment not expressly approved by Stratasys, Ltd. may cause harmful interference and void the FCC authorization to operate this equipment.



This equipment has been tested and found to comply with the limits for a Class A digital device, pursuant to Part 15 of the FCC Rules. These limits are designed to provide reasonable protection against harmful interference in a commercial environment. This equipment generates, uses and can radiate radio frequency energy and, if not installed and used in accordance with the instructions, may cause harmful interference to radio communications. Operation of this equipment in a residential area is likely to cause harmful interference, in which case the user will be required to correct the interference at their own expense.

## Canada Electromagnetic compatibility (EMC)

### Normes de Sécurité (Canada)

Le présent appareil numérique n'émet pas de bruits radioélectriques dépassant les limites applicables aux appareils numériques de Classe A prescrites dans le règlement sur le brouillage radioélectrique édicté par le Ministère des Communications du Canada.

### DOC Statement (Canada)

This digital apparatus does not exceed the Class A limits for radio noise emissions from digital apparatus set out in the Radio Interference Regulations of the Canadian Department of Communications.

## MSDS (Material Safety Data Sheet)

You can obtain current Material Safety Data Sheets for printer materials from the Stratasys website at: <http://www.stratasys.com/materials/material-safety-data-sheets>.

## Disposal of Waste Equipment by Users in Private Households in the European Union



This symbol on the product or on its packaging indicates that this product must not be disposed of with your other household waste. Instead, it is your responsibility to dispose of your waste equipment by handing it over to a designated collection point for the recycling of waste electrical and electronic equipment. The separate collection and recycling of your waste equipment at the time of disposal will help to conserve natural resources and ensure that it is recycled in a manner that protects human health and the environment. For more information about where you can drop off your waste equipment for recycling, please contact your local city office, your household waste disposal service or the shop where you purchased the product.



[www.stratasys.com](http://www.stratasys.com)



[c-support@stratasys.com](mailto:c-support@stratasys.com)  
Copyright © 2021 Stratasys Ltd. All rights reserved.  
405681-0001\_REV\_C

**stratasys**<sup>®</sup>

THE 3D PRINTING SOLUTIONS COMPANY



info@stratasys.com

STRATASYS.COM

ISO 9001:2008 Certified

© Copyright 2021 Stratasys Inc. All rights reserved.

For more information about Stratasys systems, materials, and applications call 888.480.3548 or visit [www.stratasys.com](http://www.stratasys.com).

#### DOCUMENTATION FEEDBACK

Customers, resellers, and Stratasys employees are encouraged to send comments about our documentation and training to [c-support@stratasys.com](mailto:c-support@stratasys.com). We greatly value your comments, review all of them, and use them to improve subsequent releases of the documentation. In your email message please include the document title, part number (located on the front cover), and page number. Please note that we do not respond to general questions or support requests submitted to this email address.

**stratasys**

THE 3D PRINTING SOLUTIONS COMPANY